

SHOT
BOT LIGHTING

SORGENTI E APPARECCHI
2025-26

catalogo

SHOT

BOT LIGHTING

PER UN FUTURO ILLUMINATO
FOR A BRIGHT FUTURE

40 AGENZIE IN ITALIA

Oltre 2000 clienti attivi nei settori del materiale elettrico, ferramenta, illuminazione, fai da te e GDS.

40 AGENCIES ACROSS ITALY

Over 2,000 active clients in the fields of electrical supplies, hardware, lighting specialists, DIY, and large-scale retail.



RICERCA E SVILUPPO

L'azienda dispone di un laboratorio tecnico interno per il costante controllo della qualità.

RESEARCH AND DEVELOPMENT

The company has an in-house technical laboratory for continuous quality control.



Bot Lighting da oltre 40 anni porta luce negli spazi di tutti con soluzioni innovative e di alta qualità.

Grazie a una rete capillare di 40 agenzie e 2.000 distributori in Italia, rispondiamo in modo rapido e affidabile alle esigenze dei nostri clienti.

Crediamo nell'innovazione, nel design raffinato e nella sostenibilità, supportati da una logistica efficiente e da rapporti solidi costruiti su professionalità e dinamismo.

La nostra missione è rendere l'illuminazione avanzata accessibile a tutti, usando le migliori tecnologie per offrire efficienza, design e rispetto per l'ambiente.

Con la nostra cultura della luce, vogliamo trasformare ogni spazio migliorando la qualità della vita.

For over 40 years, Bot Lighting has brought light into people's spaces with innovative, high-quality solutions.

With a widespread network of 40 agencies and 2,000 distributors across Italy, we respond quickly and reliably to our customers' needs.

We believe in innovation, essential design, and sustainability, supported by efficient logistics and strong relationships built on professionalism and dynamism.

Our mission is to make advanced lighting accessible to everyone, using the latest technologies to deliver efficiency, style, and environmental responsibility.

Through our passion for light, we aim to transform spaces and enhance quality of life.

PRESENZA INTERNAZIONALE

Bot Lighting è presente anche in Europa, con distributori e agenzie specializzate in Francia, Germania, Spagna, Slovenia, Malta e Grecia.

INTERNATIONAL PRESENCE

Bot Lighting is also present in Europe, with specialized distributors and agencies in France, Germany, Spain, Slovenia, Malta, and Greece.



SEDI OPERATIVE

- Cazzago di Pianiga (Venezia): sede logistica e commerciale di 3000 mq.
- Padova: sede logistica in outsourcing di 2000 mq.
- Quarto d'Altino (Venezia): sede logistica in outsourcing di 1500 mq.

OPERATIONAL SITES:

- Cazzago di Pianiga (Venice): 3,000 sqm logistics and commercial headquarters.
- Padua: 2,000 sqm outsourced logistics site.
- Quarto d'Altino (Venice): 1,500 sqm outsourced logistics site.

LA NOSTRA STORIA

OUR STORY

Da oltre 40 anni trasformiamo la luce in espressione e innovazione, unendo passione, sostenibilità e ricerca.

Forti della nostra storia, guardiamo al futuro per creare nuove storie di luce.

For over 40 years, we have turned light into innovation and expression, driven by passion, sustainability, and a spirit of discovery. Rooted in our history, we look to the future to create new stories of light.



1921

NELLA VETRERIA DI AIRAM NASCONO LE PRIME SORGENTI LUMINOSE, FATTE A MANO IN VETRO SOFFIATO

IN AIRAM GLASSWORKS THE FIRST LIGHT SOURCES WERE CREATED, MADE BY HAND AND THROUGH THE ART OF GLASSBLOWING.



1970

GIANNI BOT IMPORTA LE LUCI AIRAM E LE PROPONE CON SUCCESSO NEL MERCATO ITALIANO

GIANNI BOT IMPORTS AIRAM LIGHTS AND SUCCESSFULLY PROPOSES THEM IN THE ITALIAN MARKET.

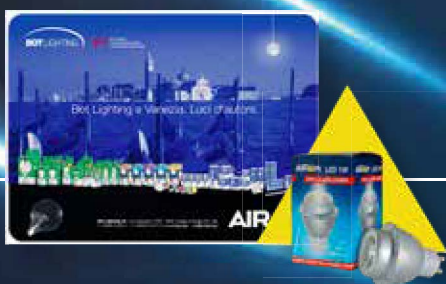

2005

BOT LIGHTING ENTRA NEL MERCATO DELLE SORGENTI LED

BOT LIGHTING ENTERS THE LED LIGHT SOURCE MARKET



2015

SPECIALISTI NELLA PRODUZIONE DI LAMPADE DECORATIVE CON TECNOLOGIA LED

SPECIALISTS IN THE PRODUCTION OF DECORATIVE LAMPS WITH LED TECHNOLOGY

SHOT

BOT LIGHTING



**GUARDA IL VIDEO
DELLA NOSTRA STORIA**

WATCH THE VIDEO
OF OUR STORY



1982

**VALLI MENEGALDO
FONDA L'AZIENDA
BOT LIGHTING SRL**

VALLI MENEGALDO FOUNDS
THE COMPANY BOT LIGHTING
SRL



1990

**INIZIANO LE PRIME RELAZIONI
E FORNITURE INTERNAZIONALI
CON IL FAR EAST**

THE FIRST INTERNATIONAL
RELATIONS AND TRADE DEALS
ARE ESTABLISHED WITH THE FAR
EAST



2000

**LEADERSHIP NELLA VENDITA E NELLA
COMMERCIALIZZAZIONE DELLE
LAMPADRE CFL**

LEADERSHIP ROLE IN THE SALE
AND MARKETING OF CFL
LAMPS



2020

**EVOLUZIONE TECNOLOGICA
CON LE LINEE SMART HOME**

TECHNOLOGICAL EVOLUTION
WITH SMART HOME LINES

**40TH
ANNIVERSARY
1982-2022**

2022

**CELEBRAZIONE DEL 40°
ANNIVERSARIO DALLA
FONDAZIONE**

CELEBRATION OF 40TH
ANNIVERSARY SINCE
FOUNDING



2025

**IMPEGNO NELLO SVILUPPO DI
LAMPADRE SEMPRE PIÙ EFFICIENTI,
DI DESIGN ED ECOSOSTENIBILI**

COMMITMENT TO
DEVELOPING LAMPS THAT ARE
EVER MORE EFFICIENT,
STYLISH,
AND ENVIRONMENTALLY
SUSTAINABLE

DA OLTRE 40 ANNI SPECIALISTI E LEADER DI SETTORE FOR OVER 40 YEARS, SPECIALISTS AND INDUSTRY LEADERS

Da sempre puntiamo all'eccellenza, unendo innovazione, esperienza e passione in ogni progetto.

La nostra forza nasce dalla costante ricerca, dalla cura nei dettagli e da una visione orientata al futuro. Ogni fase, dalla progettazione alla produzione, è seguita con attenzione e professionalità per offrire soluzioni all'avanguardia e garantire qualità, affidabilità e servizio su misura.

Affidati a chi da oltre quarant'anni fa della luce la propria missione.

We have always aimed for excellence, combining innovation, experience, and passion in every project.

Our strength comes from continuous research, attention to detail, and a forward-looking vision. Every stage, from design to production, is managed with care and professionalism to deliver cutting-edge solutions and ensure quality, reliability, and tailored service.

Trust those who have made light their mission for over forty years.



I NOSTRI FOCUS

OUR KEY POINTS



Progettazione illuminotecnica

Progetti personalizzati per illuminare al meglio ogni ambiente.

Lighting Design

Custom projects to optimally illuminate every environment.



Dipartimento R&D

Innovazione costante e sviluppo di nuove soluzioni.

R&D Department

Constant innovation and development of new solutions.



Servizio, assistenza e garanzia

Supporto qualificato in ogni fase.

Service, Support and Warranty

Qualified support at every stage.



Controllo qualità

Nella nostra sede con verifiche approfondite dal prototipo alla produzione.

Quality Control

In our headquarter through inspections from prototype to production.



Packaging e interazione con la produzione

Cura e attenzione in ogni dettaglio.

Packaging and Production integration

Care and attention to every detail.



Marketing e attività digital

Comunicazione e presentazione efficace dei prodotti. Presenza online aggiornata con nuove strategie digitali.

Marketing and Digital Activities

Effective product communication and presentation. Updated online presence and digital strategies.

SOSTENIBILITA' E VALORE PER L'AMBIENTE

SUSTAINABILITY AND ENVIRONMENTAL VALUE



ECOSOSTENIBILITÀ PRODOTTI

Prodotti innovativi ed efficienti. Gamma solare in espansione, LED sempre più performanti e tecnologie IoT per un controllo intelligente della luce.

ECO-SUSTAINABILITY PRODUCTS

Expanding solar range, increasingly high-performance LEDs and IoT technologies for intelligent light control



PACKAGING SOSTENIBILE

Riduzione e sostituzione della plastica con materiali riciclati e riciclabili, nuove scatole e pallets eco-friendly, ed etichettatura ambientale aggiornata.

SUSTAINABLE PACKAGING

Reduction and replacement of plastic with recycled and recyclable materials, new eco-friendly boxes and pallets, and updated environmental labeling.



UFFICI E SEDE

Sede con illuminazione regolabile, gestione efficiente dell'energia, riduzione della plastica e smart working per un impatto ambientale sempre più basso.

OFFICES AND HEADQUARTERS

Headquarters featuring adjustable lighting, efficient energy management, plastic reduction and smart working for an increasingly lower environmental impact.

Bot Lighting è da sempre attenta al risparmio energetico e alla sostenibilità, adottando le migliori tecnologie LED e processi produttivi rispettosi dell'ambiente.

Oggi i nostri prodotti offrono ancora più valore grazie a un design curato in ogni dettaglio e all'uso crescente di materiali riciclati ed ecosostenibili. Da sempre, lavoriamo per un futuro più luminoso e sostenibile.

Bot Lighting has always focused on energy saving and sustainability, choosing the best LED technologies and environmentally friendly manufacturing processes.

Today, our products are even more valuable thanks to attention to detail in design and the growing use of recycled and eco-friendly materials. We have always worked for a brighter, more sustainable future.

SHOT
BOT LIGHTING

LAMPADINE / LIGHT BULBS

IOT / SMART

GOCCIA STICK SMART A60 TUNABLE WHITE	p. 35
GOCCIA OPALE SMART RGB + TUNABLE WHITE	p. 36
SFERA OPALE SMART RGB + TUNABLE WHITE	p. 36
OLIVA OPALE SMART RGB + TUNABLE WHITE	p. 36
GLOBO 95 OPALE SMART RGB + TUNABLE WHITE	p. 37
REFLECTOR R80 OPALE SMART RGB + TUNABLE WHITE	p. 37
GU10 SMART RGB + TUNABLE WHITE	p. 37

CLASSE A / A CLASS

GOCCIA LED STICK H	p. 40
SFERA LED STICK H	p. 40
OLIVA LED STICK H	p. 41
GLOBO 125 LED STICK H	p. 41

FILAMENTO BIANCO / WHITE STICK

GOCCIA WHITE FILAMENT	p. 43
SFERA WHITE FILAMENT	p. 43
OLIVA WHITE FILAMENT	p. 44
GLOBO WHITE FILAMENT	p. 44

LED STICK

GOCCIA LED STICK CRI >95	p. 47
SFERA LED STICK CRI >95	p. 47
OLIVA LED STICK CRI >95	p. 47
GOCCIA LED STICK DIMMERABILE	p. 48
SFERA LED STICK DIMMERABILE	p. 48
OLIVA LED STICK DIMMERABILE	p. 49
OLIVA LED STICK SATINATA DIMMERABILE	p. 49
GLOBO 125 LED STICK DIMMERABILE	p. 50
GLOBO 125 LED SPRING DIMMERABILE	p. 50
TUBOLARE T38 LED STICK DIMMERABILE	p. 50
GOCCIA LED STICK	p. 51
SFERA LED STICK	p. 52
OLIVA LED STICK	p. 53
TORTIGLIONE LED STICK	p. 53
FIAMMA LED STICK	p. 54
GLOBO 95 LED STICK	p. 55
GLOBO 125 LED STICK	p. 55
PICCOLA PERA LED STICK	p. 56
TUBOLARE T20 LED STICK	p. 56

TUBOLARE T25 LED STICK	p. 57
TUBOLARE T32 LED STICK	p. 57
GOCCIA LED STICK SATINATA	p. 59
SFERA LED STICK SATINATA	p. 59
OLIVA LED STICK SATINATA	p. 60
TORTIGLIONE LED STICK SATINATA	p. 60
FIAMMA LED STICK SATINATA	p. 61
GLOBO 125 LED STICK SATINATA	p. 61
REFLECTOR R39 LED STICK SATINATA	p. 61
REFLECTOR R50 LED STICK SATINATA	p. 62
REFLECTOR R63 LED STICK SATINATA	p. 62
REFLECTOR R80 LED STICK SATINATA	p. 62
REFLECTOR R125 LED STICK SATINATA DIMMERABILE	p. 63
GOCCIA LED STICK CUPOLA ARGENTATA	p. 63
SFERA LED STICK CUPOLA ARGENTATA	p. 63
GOCCIA LED STICK CON SENSORE CREPUSCOLARE	p. 64

FULL LIGHT

GOCCIA FULL LIGHT	p. 66
SFERA FULL LIGHT	p. 66
OLIVA FULL LIGHT	p. 67
TORTIGLIONE FULL LIGHT	p. 67
FIAMMA FULL LIGHT	p. 67
GLOBO 95 FULL LIGHT	p. 68
GLOBO 125 FULL LIGHT	p. 68
GOCCIA FULL LIGHT DIMMERABILE	p. 69
SFERA FULL LIGHT DIMMERABILE	p. 69
OLIVA FULL LIGHT DIMMERABILE	p. 69
GLOBO 125 FULL LIGHT DIMMERABILE	p. 70
TUBOLARE T38 FULL LIGHT DIMMERABILE	p. 70

VINTAGE

EDISON LED STICK GOLD	p. 72
GOCCIA LED STICK GOLD	p. 72
OLIVA LED STICK GOLD	p. 72
TORTIGLIONE LED STICK GOLD	p. 73
GLOBO 95 LED STICK GOLD	p. 73
GLOBO 125 LED STICK GOLD	p. 73
GOCCIA F.O.B. STICK DIMMERABILE	p. 74
GLOBO F.O.B. STICK DIMMERABILE	p. 74
BT F.O.B. STICK DIMMERABILE	p. 74
ALVEARE F.O.B. STICK DIMMERABILE	p. 75
UFO F.O.B. STICK DIMMERABILE	p. 75
LANTERNA F.O.B. STICK DIMMERABILE	p. 75

SMD

GOCCIA OPALE A60	p. 78
GOCCIA OPALE A67	p. 79
GOCCIA OPALE A80	p. 79
SFERA OPALE E27	p. 80
SFERA OPALE E14	p. 81
OLIVA OPALE	p. 82
GLOBO 95 OPALE	p. 83
GLOBO 120 OPALE	p. 83
GOCCIA OPALE DIMMERABILE	p. 84
SFERA OPALE DIMMERABILE	p. 84
OLIVA OPALE DIMMERABILE	p. 84
PICCOLA PER PER FRIGORIFERI	p. 85
PICCOLA PERA	p. 85
PICCOLA PERA COLORATA	p. 86
PICCOLA PERA 24V DC	p. 86
TUBOLARE T37	p. 87
TUBOLARE T45	p. 87
REFLECTOR R39	p. 88
REFLECTOR R50	p. 88
REFLECTOR R63	p. 89
REFLECTOR R80	p. 89
LED GU10 H - 36°	p. 90
LED GU10 HP - 36°	p. 90
LED GU10 - 36°	p. 91
LED GU10 - 60°	p. 91
LED GU10 H - 100°	p. 92
LED GU10 HP - 100°	p. 92
LED GU10 - 110°	p. 93
LED GU10 DIMMERABILE	p. 93
LED GU10 ALL-GLASS FASCIO STRETTO	p. 94
LED GU10 ALL-GLASS H	p. 94
LED GU10 ALL-GLASS	p. 94
LED GU10 ALTA TEMPERATURA	p. 95
LED GU10 ALL-GLASS DIMMERABILE	p. 95
LED MR11	p. 96
LED MR16	p. 96
LED MR16 ALL-GLASS	p. 97
LED MR16 ALL-GLASS DIMMERABILE	p. 97
LED PAR30 WATERPROOF IP65 DIMMERABILE	p. 98
LED PAR38 WATERPROOF IP65 DIMMERABILE	p. 98
LED BISPINA G4	p. 99
LED BISPINA G4 SATINATA	p. 99

LED BISPINA G4 CHIARA	p. 99
LED G9 ALL-GLASS	p. 100
LED G9	p. 100
LED G9 DIMMERABILE	p. 101
LED G9 COB	p. 101
LED LINEARE R7S	p. 102
LED LINEARE R7S DIMMERABILE	p. 102
LED LINEARE R7S 78MM	p. 103
LED LINEARE R7S 2000LM DIMMERABILE	p. 103
PL ALC LED	p. 104
PL AL LED	p. 104
PL ALL LED	p. 104
LED AR111 CRI>97 DIMMERABILE	p. 105
LED GX53	p. 105
LED LINEARLINE 300MM	p. 106
LED LINEARLINE 500MM	p. 106
LED LINEARLINE 1000MM	p. 106
LAMPADA ELLITTICA SMD HID	p. 107
LAMPADA ELLISSOIDALE ALTA POTENZA HID	p. 107
LAMPADA TUBOLARE ALTA POTENZA HID	p. 108

SPECIALI / SPECIAL

GOCCIA OPALE CON SENSORE CREPUSCOLARE	p. 110
GOCCIA OPALE CON SENSORE DI MOVIMENTO E CREPUSCOLARE	p. 110
GOCCIA OPALE 12/24V AC/DC	p. 110
GOCCIA LED FROST PER CELLA FRIGORIFERA -40 °C	p. 111
GOCCIA LED ANTIZANZARE	p. 111
GOCCIA LED PER SAUNA +60 °C	p. 111
GOCCIA LED SURGE PROTECTION	p. 112
LED PLANT PAR20 PER CRESCITA PIANTE	p. 112
LED PLANT PAR30 PER CRESCITA PIANTE	p. 112
LAMPADA CCT	p. 113

TUBI LED / LED TUBES

TUBO LED VETRO T8 A-CLASS	p. 114
TUBO LED VETRO T8 HIGH EFFICENCY	p. 114
TUBO LED VETRO T8	p. 115
TUBO LED VETRO T8 SE	p. 116
TUBO LED VETRO T8 FOOD	p. 116
TUBO LED VETRO T5 - MAINS	p. 117
CIRCOLINE LED	p. 117
STARTER PER TUBI T8 A LED	p. 117

SORGENTI TRADIZIONALI / TRADITIONAL LIGHT BULBS

LAMPADE ALOGENE HALOGEN LAMPS

LINEARE ENERGY SAVING R7S DIMMERABILE	p. 120
SPOT RAGGI INFRAROSSI	p. 120

LAMPADE AD INCANDESCENZA / INCANDESCENT BULBS

PICCOLA PERA CHIARA	p. 121
PICCOLA PERA CHIARA PER FORNI 300 °C	p. 121

LAMPADE FLUORESCENTI / FLUORESCENT LAMPS

CIRCOLARI TRIFOSFORO T9	p. 122
STARTER PER LAMPADE FLUORESCENTI	p. 122

SCARICA IODURI / IODIDE DISCHARGE

NCK-G CERAMIC	p. 123
NCK-TC CERAMIC	p. 123
NACHROMA DOPPIO ATTACCO	p. 124
NACHROMA ELLISSOIDALE DIFFONDENTE	p. 124
NATRALOX SUPER TUBOLARE TRASPARENTE	p. 125

LAMPADE UVC / UVC LAMPS

PL UVC	p. 126
TUBO T5 UVC	p. 127
TUBO T8 UVC	p. 127

APPARECCHI TECNICO / TECHNICAL LIGHTING FIXTURES

PLAFONIERE / CEILING LIGHTS

IRIS ROUND Plafoniera CCT / CCT ceiling light	p. 130
IRIS SQUARED Plafoniera CCT / CCT ceiling light	p. 131
VAASA Plafoniera CCT / CCT ceiling light	p. 132
VAASA BIG Plafoniera CCT / CCT ceiling light	p. 133
JUPITER Plafoniera PIR / PIR ceiling light	p. 134
LINDA Plafoniera CCT / CCT ceiling light	p. 135
COCO Plafoniera / Ceiling light	p. 136
RIO Plafoniera / Ceiling light	p. 138
RIO RADAR Plafoniera con radar / Radar ceiling light	p. 139
ERIKA ROUND Plafoniera CCT / CCT ceiling light	p. 140
ERIKA SQUARED Plafoniera CCT / CCT ceiling light	p. 141
NORA ROUND Plafoniera CCT / CCT ceiling light	p. 142
NORA SQUARED Plafoniera CCT / CCT ceiling light	p. 144
SONO III PIR Plafoniera PIR / PIR ceiling light	p. 146
GIADA II Plafoniera multifunzione ad alta resistenza / High resistance multifunctional ceiling light	p. 148
SONJA Plafoniera / Ceiling light	p. 150
SONJA OVAL Plafoniera / Ceiling light	p. 151
OVIDEO ROUND Plafoniera CCT / CCT ceiling light	p. 152
OVIDEO OVAL Plafoniera CCT / CCT ceiling light	p. 153
BURGOS Plafoniera CCT / CCT ceiling light	p. 156

PANNELLI LED / LED PANELS

PANNELLO LED BACKLIT 600X600 ALTA EFFICIENZA 600X600 HIGH EFFICIENCY BACKLIT LED PANEL	p. 160
PANNELLO LED BACKLIT 600X600 ALTA EMISSIONE 600X600 HIGH EMISSION BACKLIT LED PANEL	p. 161
PANNELLO LED BACKLIT 600X600 600X600 BACKLIT LED PANEL	p. 162
PANNELLO LED BACKLIT 600X600 - VALUE 4PACK 600X600 BACKLIT LED PANEL - VALUE 4PACK	p. 163
PANNELLO LED BACKLIT 300X1200 300X1200 BACKLIT LED PANEL	p. 164
PANNELLO LED EDGELIT 600X600 600X600 EDGELIT LED PANEL	p. 165

PANNELLO LED EDGELIT 300X1200 300X1200 EDGELIT LED PANEL	p. 166
DRIVER PER PANNELLI LED DRIVER FOR LED PANELS	p. 168
KIT MONTAGGIO PANNELLI PANELS MOUNTING KIT	p. 168
DRIVER DALI / PUSH / 0-10V MULTIFUNZIONE / MULTIFUNCTION	p. 170
DRIVER DALI/PUSH MULTIFUNZIONE / MULTIFUNCTION	p. 171
KIT EMERGENZA MULTIFUNZIONE / MULTIFUNCTION EMERGENCY KIT	p. 172

DOWLIGHTS

DOWNLIGHT OSLO ROUND Con cornice intercambiabile / With interchangeable frame	p. 176
DOWNLIGHT BIG OSLO ROUND Con cornice intercambiabile / With interchangeable frame	p. 177
DOWNLIGHT OSLO SQUARED Con cornice intercambiabile / With interchangeable frame	p. 178
DOWNLIGHT BODO CCT	p. 180
DOWNLIGHT BODO II CCT DIMMERABILE	p. 181
DOWNLIGHT BODO Downlight orientabile / Adjustable downlight	p. 182
ANELLI DI FISSAGGIO ORIENTABILI ADJUSTABLE FIXING RINGS	p. 184
ANELLO DI FISSAGGIO FISSO CON VETRO FRONTALE IP65 IP65 FIXING RING WITH FRONT GLASS	p. 184
ANELLI DI FISSAGGIO ORIENTABILI PER GU10 ADJUSTABLE FIXING RINGS FOR GU10	p. 185

TRACKLIGHTS

BERNA Sospensione da binario / Track pendant	p. 188
ZURIGO Lampada a sospensione / Pendant lamp	p. 189
GRAZ Proiettore da binario / Tracklight	p. 190
LINZ Faretto spot / Spotlight	p. 191
WELS Proiettore da binario / Tracklight	p. 192
VIENNA 30W CRI>97 Proiettore da binario / Tracklight	p. 194
VIENNA 40W CRI>90 Proiettore da binario / Tracklight	p. 196
BINARI ED ACCESSORI / TRACKLIGHT AND ACCESSORIES	p. 198

STRISCE LED / LED STRIPS

HD LED STRIP IP20 24V Striscia LED / LED Strip	p. 204
COLOR STRIP IP20 24V Striscia LED / LED Strip	p. 205
SMD LED STRIP IP20 24V Striscia LED / LED Strip	p. 206
HD LED STRIP IP54 24V Striscia LED / LED Strip	p. 207
SMD LED STRIP IP54 24V Striscia LED / LED Strip	p. 208

SMD LED STRIP IP67 24V Striscia LED / LED Strip	p. 209
CSP LED STRIP IP20 24V Striscia LED / LED Strip	p. 210
COB LED STRIP IP20 24V Striscia LED / LED Strip	p. 211
COB LED STRIP IP20 48V Striscia LED / LED Strip	p. 212
COB LED STRIP IP65 48V Striscia LED / LED Strip	p. 213
DRIVER PER STRIP LED STRIP LED DRIVERS	p. 214
DIMMER PER STRIP LED LED STRIP DIMMER	p. 215
PROFILI PER STRIP LED LED STRIP PROFILES	p. 216
ACCESSORI PER STRIP LED LED STRIP ACCESSORIES	p. 218

MODULI LED / LED MODULES

MOD-A Modulo Led circolare magnetico / Magnetic circular Led module	p. 222
MOD-B Modulo Led circolare magnetico / Magnetic circular Led module	p. 223
MOD-C Modulo Led circolare magnetico / Magnetic circular Led module	p. 224
MODULO LED SLIM	p. 225
SEGOVIA LED Accessorio / Accessory	p. 226
LAGOS LED Accessorio / Accessory	p. 227

REGLETTE E SISTEMI COMPONIBILI / REGLETTE AND MODULAR SYSTEMS

EVA Plafoniera flat Led CCT / CCT flat Led ceiling light	p. 230
LED T5 BAR Sistema modulare di barre Led / Led Modular system	p. 231
YGS - Switch Fisico Reglette Led CCT con selettore / CCT Led reglette with selector	p. 232
YGQ - Switch Fisico Reglette Led CCT con selettore / CCT Led reglette with selector	p. 233
YGR - Switch Fisico Reglette Led CCT regolabile / Adjustable CCT Led reglette	p. 234
YGB - Switch Fisico Sottopensile CCT / CCT cabinet light	p. 235

PLAFONIERE STAGNE / TRI-PROOF

PLAFONIERA STAGNA VUOTA PER TUBI LED EMPTY SLIM-TRIPROOF FOR LED TUBES	p. 238
PLAFONIERA STAGNA A LED SLIM SLIM LED TRI-PROOF	p. 239
PLAFONIERA STAGNA A LED SLIM - PASSANTE SLIM LED TRI-PROOF - PASS THROUGH	p. 240
PLAFONIERA STAGNA A LED SLIM - EMERGENZA SLIM LED TRI-PROOF - EMERGENCY	p. 241
PLAFONIERA STAGNA A LED SLIM - RADAR SLIM LED TRI-PROOF - RADAR	p. 242

PLAFONIERA STAGNA A LED SLIM LD3 p. 243
LD3 SLIM LED TRI-PROOF

HIGH BAY

HIGH BAY LED 150 p. 246
Proiettore High bay LED 150W /
High power Led high bay 150W

HIGH BAY LED 200 p. 247
Proiettore High bay LED 200W /
High power Led high bay 200W

SS DOB HIGH BAY p. 248
Proiettore High Bay Led DOB / DOB
Led High Bay

PROIETTORI / FLOODLIGHTS

ORLANDO 10 p. 252
Proiettore a Led slim / Slim Led
floodlight

ORLANDO 20 p. 254
Proiettore a Led slim / Slim Led
floodlight

ORLANDO 20 PIR p. 255
Proiettore a Led slim / Slim Led
floodlight

ORLANDO 30 p. 256
Proiettore a Led slim / Slim Led
floodlight

ORLANDO 30 PIR p. 257
Proiettore a Led slim / Slim Led
floodlight

ORLANDO 50 p. 258
Proiettore a Led slim / Slim Led
floodlight

ORLANDO 50 PIR p. 259
Proiettore a Led slim / Slim Led
floodlight

ORLANDO 90 p. 260
Proiettore a Led slim / Slim Led
floodlight

ORLANDO 150 p. 262
Proiettore a Led slim / Slim Led
floodlight

ORLANDO 200 p. 263
Proiettore a Led slim / Slim Led
floodlight

KYOTO 100 p. 264
Proiettore a Led professionale /
Professional Led floodlight

KYOTO 150 p. 265
Proiettore a Led professionale /
Professional Led floodlight

KYOTO 200 p. 266
Proiettore a Led professionale /
Professional Led floodlight

KYOTO 300 p. 267
Proiettore a Led professionale /
Professional Led floodlight

KYOTO 500 p. 268
Proiettore a Led professionale /
Professional Led floodlight

ATLANTA CCT p. 270
Proiettore a Led / Led floodlight

AKRON 2 p. 272
Proiettore a Led 12/24V /
12/24V Led floodlight

RESIDENZIALE / RESIDENTIAL

INTERNI SOFFITTO / PENDANTS

LOFT35 p. 276
Lampada a sospensione /
pendant lamp

SANSA p. 279
Lampada a sospensione /
pendant lamp

URBAN p. 280
Lampada a sospensione /
pendant lamp

TAVOLO PAVIMENTO / TABLE AND FLOOR

URBAN DESK S p. 284
Lampada da tavolo / Table lamp

URBAN DESK L p. 287
Lampada da tavolo / Table lamp

URBAN FLOOR p. 288
Lampada da terra / Floor lamp

CARA LED CLIP p. 290
Lampada con fissaggio a clip /
Clip wall lamp

CARA LED WALL p. 291
Applique / Wall lamp

CARA LED TABLE p. 292
Lampada da tavolo / Table lamp

LAMPADE RICARICABILI / RECHARGEABLE TABLE LAMPS

SAN p. 296
Lampada da tavolo ricaricabile /
Rechargeable table lamp

EMMA p. 298
Lampada da tavolo ricaricabile /
Rechargeable table lamp

EMMA MINI p. 300
Lampada da tavolo ricaricabile /
Rechargeable table lamp

MAYA p. 302
Lampada da tavolo ricaricabile /
Rechargeable table lamp

TAG p. 304
Lampada da tavolo ricaricabile /
Rechargeable table lamp

MAGNETIKA p. 306
Lampada da tavolo ricaricabile
multifunzione/ Multifunction
rechargeable table lamp

TIZIA p. 308
Lampada da tavolo ricaricabile
solare / Rechargeable table and
solar lamp

GARDEN RESIDENZIALE / RESIDENTIAL OUTDOOR

ALICANTE p. 312
Applique / Wall lamp

MADRID 7 p. 314
Applique / Wall lamp

MADRID 24 p. 316
Applique / Wall lamp

NIVES1 p. 318
Applique singola emissione /
Single emission wall lamp

NIVES2 p. 320
Applique doppia emissione/
Double emission wall lamp

LUNA p. 322
Applique / Wall lamp

NORAMINI p. 324
Applique / Wall lamp

MARBELLA SQUARED p. 326
Applique / Wall lamp

MARBELLA ROUND p. 327
Applique / Wall lamp

MARBELLA BIG SQUARED p. 328
Applique / Wall lamp

MARBELLA DUO p. 330
Applique / Wall lamp

RONDA p. 332
Plafoniera / Ceiling light

MALAGA p. 334
Plafone / Ceiling lamp

ALMERIA p. 335
Plafone / Ceiling lamp

TOLEDO 1 p. 336
Applique singola emissione /
Single emission wall lamp

TOLEDO 2 p. 337
Applique doppia emissione /
Double emission wall lamp

TOLEDO 10 p. 338
Applique / Wall lamp

SUND p. 340
Applique singola emissione /
Single emission wall lamp

SUND DUO p. 341
Applique doppia emissione /
Double emission wall lamp

CORDOVA 1 p. 342
Applique singola emissione /
Single emission wall lamp

CORDOVA 2 p. 343
Applique doppia emissione /
Double emission wall lamp

CORDOVA 10 p. 344
Applique / Wall lamp

AVILA p. 346
Applique con sensore crepuscolare /
Wall light with dusk sensor

ALPILA 1S p. 348
Applique singola emissione /
Single emission wall lamp

ALPILA 2S p. 349
Applique doppia emissione /
Double emission wall lamp

ALPILA XL p. 350
Applique doppia emissione /
Double emission wall lamp

GRANADA p. 351
Applique doppia emissione /
Double emission wall lamp

GRANADA2 p. 352
Applique singola emissione /
Single emission wall lamp

GRANADA2 DUO p. 353
Applique doppia emissione /
Double emission wall lamp

BARREL p. 354
Lanterna da muro /
Wall mounted lantern

JEREZ p. 356
Applique / Wall lamp

ARVIKA p. 357
Applique / Wall lamp

MAIORCA p. 358
Applique / Wall lamp

SEGOVIA 1 p. 360
Applique / Wall lamp

LAGOS 1 p. 362
Applique / Wall lamp

INDICE / INDEX

LAGOS 2 Applique / Wall lamp	p. 364	COVER ARONA 300 Cover magnetiche / magnetic covers	p. 403	YUMA1200P Palo solare da giardino / Garden solar bollard light	p. 444	
VALENCIA Applique / Wall lamp	p. 366	HOLM Segnapasso calpestabile / Walkover light	p. 406	CLAY Applique solare / Solar wall lamp	p. 446	
VALENCIA2 Applique doppia emissione/ Double emission wall lamp	p. 368	AITONA Segnapasso calpestabile / Walkover light	p. 408	AVENUE Applique solare / Solar wall lamp	p. 448	
VIGO 1 Applique / Wall lamp	p. 370	GARDA DESK Lampada da tavolo per esterni / Outdoor table lamp	p. 410	MOON Applique solare / Solar wall lamp	p. 450	
VIGO 2 Applique / Wall lamp	p. 371	GARDA FLOOR Lampada da terra per esterni / Outdoor floor lamp	p. 412	YUCCA Applique solare / Solar wall lamp	p. 452	
VIGO 3 Applique / Wall lamp	p. 372	SOLARE TECNICO / TECHNICAL SOLAR				
VIGO 4 Applique / Wall lamp	p. 373	KALAP Lampione solare / Solar street light	p. 416	FLAME2N Torcia a Led effetto fiamma - solare con sensore crepuscolare / Led torch with flame effect - solar powered & dusk sensor	p. 456	
CADICE Applique / Wall lamp	p. 376	YUMA1500NK Proiettore solare con pannello separato / Solar floodlight with separate panel	p. 418	PORTATILI E LEISURE / PORTABLE AND LEISURE		
CADICE BOLLARD Paletto da giardino / Outdoor bollard	p. 377	YUMA2800NK Proiettore solare con pannello separato / Solar floodlight with separate panel	p. 419	WORKLIGHTS		
KALLIO Paletto da giardino / Outdoor bollard	p. 378	YUMA4800NK Proiettore solare con pannello separato / Solar floodlight with separate panel	p. 420	WORK 50 Lampada da lavoro portatile / Portable worklight	p. 460	
IBIZA Paletto da giardino / Outdoor bollard	p. 380	YUMA11NK Proiettore solare stradale / Street solar floodlight	p. 422	WORK 10 Proiettore portatile / Worklight	p. 462	
MERIDA Paletto da giardino / Outdoor bollard	p. 381	YUMA15NK Proiettore solare stradale / Street solar floodlight	p. 424	WORK 20 Lampada da lavoro portatile / Portable worklight	p. 463	
LEON P Lanterna con paletto / Lantern lamp with pole	p. 382	YUMA40NK Proiettore solare stradale / Street solar floodlight	p. 426	FROG Proiettore multiuso ricaricabile / Rechargeable multipurpose worklight	p. 464	
LEON Lanterna / Lantern lamp	p. 383	SOLARE RESIDENZIALE / RESIDENTIAL SOLAR			LED16 Flashlight torcia portatile a led ricaricabile / Portable Rechargeable LED Torch	p. 466
LEON 12 FRAME Lanterna da muro / Wall mounted lantern	p. 384	INCLINE2N Proiettore solare / Solar floodlight	p. 430	EXPO WORKLIGHT LED COLORI VARI 9 PZ	p. 467	
LEON 12 Lanterna da muro / Wall mounted lantern	p. 386	INCLINE4N Proiettore solare / Solar floodlight	p. 431	FLASHLIGHTS / SPOTLIGHTS		
LEON 2 Plafoniera / Ceiling lamp	p. 388	INCLINE8N Proiettore solare / Solar floodlight	p. 432	LED BICYCLE FRONT LIGHT	p. 470	
SPIKY1 Picchetto da giardino / Outdoor stake light	p. 390	YUMA2N Proiettore solare / Solar floodlight	p. 434	LED BICYCLE LIGHT SET CON RICARICA USB	p. 470	
SPIKY2 Picchetto da giardino / Outdoor stake light	p. 391	YUMA8NP Proiettore e picchetto solare / Solar and stake light	p. 435	LED BICYCLE REAR RED LIGHT	p. 470	
SPIKY3 Picchetto da giardino regolabile / Adjustable outdoor stake light	p. 392	YUMA6NK Proiettore solare / Solar floodlight	p. 436	LED BICYCLE REAR RED LIGHT TARO	p. 471	
ARONA 1 Segnapasso CCT / CCT step light	p. 394	YUMA10NK Proiettore solare / Solar floodlight	p. 437	AIRAM HEADLIGHT	p. 471	
ARONA 2 Segnapasso CCT / CCT step light	p. 395	MARBELLA10SUN Applique solare / Solar wall lamp	p. 438	AIRAM POWER HEADLIGHT	p. 471	
ARONA 3 Segnapasso CCT / CCT step light	p. 396	MARBELLA POLE & SPIKE Paletto per / Pole for MARBELLA10SUN	p. 438	MAX 800 TORCIA LED FLASHLIGHT 800LM RICARICA USB	p. 472	
BILBAO 3 SQUARED Segnapasso CCT / CCT steplight	p. 398	MARBELLA9SUN Applique solare / Solar wall lamp	p. 440	EXPO CLIPPY SAFETY LIGHT LED 12 PZ	p. 472	
BILBAO 6 SQUARED Segnapasso CCT / CCT steplight	p. 399	MARBELLA POLE & SPIKE Paletto per / Pole for MARBELLA9SUN	p. 440	EXPO TORCE LED COLORI VARI 12 PZ	p. 472	
SORIA RETTANGOLARE Segnapasso CCT / CCT step light	p. 400	YUMA350P Palo solare da giardino / Garden solar bollard light	p. 442	EXPO TORCE LED13 COLORI VARI 12 PZ	p. 473	
SORIA QUADRATO Segnapasso CCT / CCT step light	p. 401	PILE ELETTRICHE / BATTERIES				
ARONA 200 Segnapasso CCT per cover magnetica / CCT steplight for magnetic cover	p. 402	EVOLUTION + ALKALINE				
COVER ARONA 200 Cover magnetiche / magnetic covers	p. 402				p. 474	
ARONA 300 Segnapasso CCT per cover magnetica / CCT steplight for magnetic cover	p. 403					

SUPER ALKALINE MULTIPACK	p. 474
ALKALINE	p. 475
LITHIUM	p. 475

NIGHT LIGHTS

LUCE NOTTURNA POWER LED CREPUSCOLARE	p. 477
LUCE NOTTURNA POWER LED CREPUSCOLARE + SENSOR	p. 477
LUCE NOTTURNA POWER LED CREPUSCOLARE ROUND	p. 477
LAMPADA DA ARMADIO CON SENSORE DI MOVIMENTO	p. 477

TIPI DI ATTACCO / SOCKETS	p. 478
----------------------------------	--------

GLOSSARIO / GLOSSARY	p. 480
-----------------------------	--------

GARANZIA / WARRANTY	p. 482
----------------------------	--------

CONDIZIONI DI VENDITA / SALES CONDITIONS	p. 483
---	--------

INDICE SORGENTI / LIGHT BULBS INDEX

IOT / SMART



GOCCIA STICK SMART A60
TUNABLE WHITE
P.35



GOCCIA OPALE SMART
RGB + TUNABLE WHITE
P.36



SFERA OPALE SMART RGB +
TUNABLE WHITE
P.36



OLIVA OPALE SMART RGB +
TUNABLE WHITE
P.36



GLOBO 95 OPALE SMART
RGB + TUNABLE WHITE
P.37



REFLECTOR R80 OPALE
SMART RGB + TUNABLE
WHITE
P.37



GU10 SMART RGB +
TUNABLE WHITE
P.37

CLASSE A / A CLASS



GOCCIA LED STICK H
P.40



SFERA LED STICK H
P.40



OLIVA LED STICK H
P.41



GLOBO 125 LED STICK H
P.41

FILAMENTO BIANCO / WHITE STICK



GOCCIA WHITE FILAMENT
P.43



SFERA WHITE FILAMENT
P.43



OLIVA WHITE FILAMENT
P.44



GLOBO WHITE FILAMENT
P.44

LED STICK



CRI>95

GOCCIA LED STICK CRI >95
P.47



CRI>95

SFERA LED STICK CRI>95
P.47



CRI>95

OLIVA LED STICK CRI >95
P.47



GOCCIA LED STICK
DIMMERABILE
P.48



SFERA LED STICK
DIMMERABILE
P.48



OLIVA LED STICK
DIMMERABILE
P.49



OLIVA LED STICK SATINATA
DIMMERABILE
P.49



GLOBO 125 LED STICK
DIMMERABILE
P.50



GLOBO 125 LED SPRING
DIMMERABILE
P.50

NEW



TUBOLARE T38 LED STICK
DIMMERABILE
P.50



GOCCIA LED STICK
P.51



SFERA LED STICK
P.52



OLIVA LED STICK
P.53



TORTIGLIONE LED STICK
P.53



FIAMMA LED STICK
P.54



GLOBO 95 LED STICK
P.55



GLOBO 125 LED STICK
P.55



PICCOLA PERA
LED STICK
P.56



TUBOLARE T20
LED STICK
P.56



TUBOLARE T25 LED STICK
P.57



TUBOLARE T32 LED STICK
P.57



GOCCIA LED STICK
SATINATA
P.59



SFERA LED STICK
SATINATA
P.59



OLIVA LED STICK
SATINATA
P.60



TORTIGLIONE LED STICK
SATINATA
P.60



FIAMMA LED STICK
SATINATA
P.61



GLOBO 125 LED STICK
SATINATA
P.61



REFLECTOR R39 LED STICK
SATINATA
P.61



REFLECTOR R50 LED STICK
SATINATA
P.62



REFLECTOR R63 LED STICK
SATINATA
P.62



REFLECTOR R80 LED STICK
SATINATA
P.62



REFLECTOR R125 LED STICK
SATINATA DIMMERABILE
P.63



GOCCIA LED STICK
CUPOLA ARGENTATA
P.63



SFERA LED STICK CUPOLA
ARGENTATA
P.63



GOCCIA LED STICK CON
SENSORE CREPUSCOLARE
P.64

INDICE SORGENTI / LIGHT BULBS INDEX

FULL LIGHT



GOCCIA FULL LIGHT
P.66



SFERA FULL LIGHT
P.66



OLIVA FULL LIGHT
P.67



TORTIGLIONE FULL LIGHT
P.67



FIAMMA FULL LIGHT
P.67



GLOBO 95 FULL LIGHT
P.68



GLOBO 125 FULL LIGHT
P.68



GOCCIA FULL LIGHT
DIMMERABILE
P.69



SFERA FULL LIGHT
DIMMERABILE
P.69



OLIVA FULL LIGHT
DIMMERABILE
P.69



GLOBO 125 FULL LIGHT
DIMMERABILE
P.70



NEW

TUBOLARE T38 FULL LIGHT
DIMMERABILE
P.70



VINTAGE



EDISON LED STICK GOLD
P.72



GOCCIA LED STICK GOLD
P.72



OLIVA LED STICK GOLD
P.72



TORTIGLIONE LED STICK
GOLD
P.73



GLOBO 95 LED STICK
GOLD
P.73



GLOBO 125 LED STICK
GOLD
P.73



GOCCIA F.O.B. STICK
DIMMERABILE
P.74



GLOBO F.O.B. STICK
DIMMERABILE
P.74



BT F.O.B. STICK
DIMMERABILE
P.74



ALVEARE F.O.B. STICK
DIMMERABILE
P.75



UFO F.O.B. STICK
DIMMERABILE
P.75



LANTERNA F.O.B. STICK
DIMMERABILE
P.75



INDICE SORGENTI / LIGHT BULBS INDEX

SMD



GOCCIA OPALE A60
P.78



GOCCIA OPALE A67
P.79



GOCCIA OPALE A80
P.79



SFERA OPALE E27
P.80



SFERA OPALE E14
P.81



OLIVA OPALE
P.82



GLOBO 95 OPALE
P.83



GLOBO 120 OPALE
P.83



GOCCIA OPALE
DIMMERABILE
P.84



SFERA OPALE
DIMMERABILE
P.84



OLIVA OPALE
DIMMERABILE
P.84



PICCOLA PERA PER
FRIGORIFERI
P.85



PICCOLA PERA
P.85



PICCOLA PERA
COLORATA
P.86



PICCOLA PERA 24V DC
P.86



TUBOLARE T37
P.87



TUBOLARE T45
P.87



REFLECTOR R39
P.88



REFLECTOR R50
P.88



REFLECTOR R63
P.89



REFLECTOR R80
P.89



LED GU10 H - 36°
P.90



LED GU10 HP - 36°
P.90



LED GU10 - 36°
P.91



LED GU10 - 60°
P.91



LED GU10 H - 100°
P.92



LED GU10 HP - 100°
P.92



LED GU10 - 110°
P.93



LED GU10 DIMMERABILE
P.93



LED GU10 ALL-GLASS
FASCIO STRETTO
P.94



LED GU10 ALL-GLASS H
P.94



LED GU10 ALL-GLASS
P.94



LED GU10 ALTA
TEMPERATURA
P.95



LED GU10 ALL-GLASS
DIMMERABILE
P.95



LED MR11
P.96



LED MR16
P.96

INDICE SORGENTI / LIGHT BULBS INDEX

SMD



LED MR16 ALL-GLASS
P.97



LED MR16 ALL-GLASS
DIMMERABILE
P.97



LED PAR30 WATERPROOF
IP65 DIMMERABILE
P.98



LED PAR38 WATERPROOF
IP65 DIMMERABILE
P.98



LED BISPINA G4
P.99



LED BISPINA G4 SATINATA
P.99



LED BISPINA G4 CHIARA
P.99



LED G9 ALL-GLASS
P.100



LED G9
P.100



LED G9 DIMMERABILE
P.101



LED G9 COB
P.101



LED LINEARE R7S
P.102



LED LINEARE R7S
DIMMERABILE
P.102



LED LINEARE R7S 78MM
P.103



LED LINEARE R7S 2000LM
DIMMERABILE
P.103



PL ALC LED
P.104



PL AL LED
P.104



PL ALL LED
P.104



LED AR111 CRI>97
DIMMERABILE
P.105



LED GX53
P.105



LED LINEARLINE 300MM
P.106



LED LINEARLINE 500MM
P.106



LED LINEARLINE 1000MM
P.106



LAMPADA ELLISSOIALE
SMD HID
P.107



LAMPADA ELLISSOIALE
ALTA POTENZA HID
P.107



LAMPADA TUBOLARE ALTA
POTENZA HID
P.108

SPECIALI / SPECIAL



GOCCIA OPALE CON
SENSORE CREPUSCOLARE
P.110



GOCCIA OPALE CON
SENSORE DI MOVIMENTO E
CREPUSCOLARE
P.110



GOCCIA OPALE 12/24V
AC/DC
P.110



GOCCIA LED FROST PER
CELLA FRIGORIFERA -40 °C
P.111



GOCCIA LED ANTIZANZARE
P.111



GOCCIA LED PER SAUNA
+60 °C
P.111

SPECIALI / SPECIAL



GOCCIA LED SURGE PROTECTION
P.112



LED PLANT PAR20 PER CRESCITA PIANTE
P.112



LED PLANT PAR30 PER CRESCITA PIANTE
P.112

NEW



LAMPADE CCT
P.113

TUBI LED / LED TUBES



TUBO LED VETRO T8 A-CLASS
P.114



TUBO LED VETRO T8 HIGH EFFICIENCY
P.114



TUBO LED VETRO T8
P.115

NEW



TUBO LED VETRO T8 SE
P.116



FOOD

TUBO LED VETRO T8 FOOD
P.116



TUBO LED VETRO T5 - MAINS
P.117

NEW



CIRCOLINE LED
P.117



STARTER PER TUBI T8 A LED
P.117

ALOGENE / HALOGEN



LINEARE ENERGY SAVING R7S DIMMERABILE
P.120



SPOT RAGGI INFRAROSSI
P.120

INCANDESCENZA / INCANDESCENT



PICCOLA PERA CHIARA
P.121



+300°C

PICCOLA PERA CHIARA PER FORNI 300 °C
P.121

INDICE SORGENTI / LIGHT BULBS INDEX

LAMPADE FLUORESCENTI / FLUORESCENT LAMPS



CIRCOLARI TRIFOSFORO T9
P. 122



**STARTER PER LAMPADE
FLUORESCENTI**
P. 122

SCARICA IODURI / IODIDE DISCHARGE



NCK-G CERAMIC
P. 123



NCK-TC CERAMIC
P. 123



**NACHROMA DOPPIO
ATTACCO**
P. 124



**NACHROMA
ELLISSOIDALE
DIFFONDENTE**
P. 124



**NATRALOX SUPER
TUBOLARE TRASPARENTE**
P. 125

LAMPADE UVC / UVC LAMPS



PL UVC
P. 126



TUBO T5 UVC
P. 127







TUBO T8 UVC
P. 127

PLAFONIERE / CEILING LIGHTS

 <p>IRIS ROUND Plafoniera CCT / CCT ceiling light P.130</p>	 <p>IRIS SQUARED Plafoniera CCT / CCT ceiling light P.131</p>	 <p>VAASA Plafoniera CCT / CCT ceiling light P.132</p>	 <p>VAASA BIG Plafoniera CCT / CCT ceiling light P.133</p>	 <p>JUPITER Plafoniera PIR / PIR ceiling light P.134</p>	 <p>LINDA Plafoniera CCT / CCT ceiling light P.135</p>
 <p>COCO Plafoniera / Ceiling light P.136</p>	 <p>RIO Plafoniera / Ceiling light P.138</p>	 <p>RIO RADAR Plafoniera con radar / Radar ceiling light P.139</p>	 <p>ERIKA ROUND Plafoniera CCT / CCT ceiling light P.140</p>	 <p>ERIKA SQUARED Plafoniera CCT / CCT ceiling light P.141</p>	 <p>NORA ROUND Plafoniera CCT / CCT ceiling light P.142</p>
 <p>NORA SQUARED Plafoniera CCT / CCT ceiling light P.144</p>	 <p>SONO III PIR Plafoniera PIR / PIR ceiling light P.146</p>	 <p>GIADA II Plafoniera multifunzione ad alta resistenza / High resistance multifunctional ceiling light P.148</p>	 <p>SONJA Plafoniera / Ceiling light P.150</p>	 <p>SONJA OVAL Plafoniera / Ceiling light P.151</p>	 <p>OVIEDO ROUND Plafoniera CCT / CCT ceiling light P.152</p>
 <p>OVIEDO OVAL Plafoniera CCT / CCT ceiling light P.153</p>	 <p>BURGOS Plafoniera CCT / CCT ceiling light P.156</p>				

PANNELLI LED / LED PANELS

 <p>PANNELLO LED BACKLIT 600X600 ALTA EFFICIENZA 600X600 HIGH EFFICIENCY BACKLIT LED PANEL P.160</p>	 <p>PANNELLO LED BACKLIT 600X600 ALTA EMISSIONE 600X600 HIGH EMISSION BACKLIT LED PANEL P.161</p>	 <p>PANNELLO LED BACKLIT 600X600 - VALUE 4PACK 600X600 BACKLIT LED PANEL - VALUE 4PACK P.163</p>	 <p>PANNELLO LED BACKLIT 300X1200 300X1200 BACKLIT LED PANEL P.164</p>	 <p>PANNELLO LED EDGELIT 600X600 600X600 EDGELIT LED PANEL P.165</p>
---	---	--	---	--

INDICE TECNICO / TECHNICAL INDEX

PANNELLI LED / LED PANELS



UGR < 19

CRI > 90

**PANNELLO LED EDGELIT
300X1200**
300X1200 EDGELIT LED PANEL
P.166



DRIVER PER PANNELLI LED
DRIVER FOR LED PANELS
P.168



**KIT MONTAGGIO
PANNELLI**
PANELS MOUNTING KIT
P.168



**DRIVER DALI / PUSH /
0-10V MULTIFUNZIONE**
MULTIFUNCTION
P.170



NEW

**DRIVER DALI / PUSH
MULTIFUNZIONE**
MULTIFUNCTION
P.171



**KIT EMERGENZA
MULTIFUNZIONE**
EMERGENCY KIT
P.172

DOWNLIGHTS

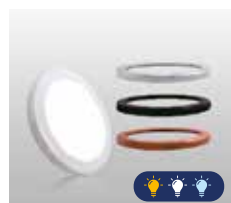

**DOWNLIGHT OSLO
ROUND**

Con cornice intercambiabile /
With interchangeable frame
P.176

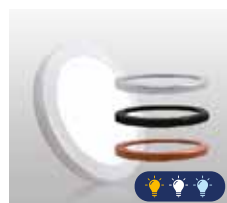

**DOWNLIGHT BIG OSLO
ROUND**

Con cornice intercambiabile /
With interchangeable frame
P.177

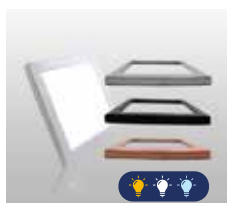

**DOWNLIGHT OSLO
SQUARED**

Con cornice intercambiabile /
With interchangeable frame
P.178

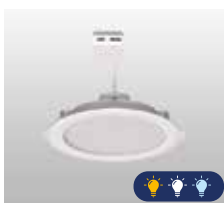

DOWNLIGHT BODO CCT
P.180



NEW

**DOWNLIGHT BODO II CCT
DIMMERABILE**
P.181



DOWNLIGHT BODO
Downlight orientabile /
Adjustable downlight
P.182



**ANELLI DI FISSAGGIO
ORIENTABILI**
ADJUSTABLE FIXING RINGS
P.184



**ANELLO DI FISSAGGIO
FISSO CON VETRO
FRONTALE IP65**
IP65 FIXING RING WITH FRONT
GLASS
P.184



**ANELLI DI FISSAGGIO
ORIENTABILI PER GU10**
ADJUSTABLE FIXING RINGS
FOR GU10
P.185

TRACK LIGHTS



BERNA
Sospensione da binario /
Track pendant
P.188



ZURIGO
Lampada a sospensione /
Pendant lamp
P.189



GRAZ
Proiettore da binario /
Tracklight
P.190



LINZ
Faretto spot / Spotlight
P.191



WELS
Proiettore da binario /
Tracklight
P.192



VIENNA 30W CRI>97
Proiettore da binario /
Tracklight
P.194



VIENNA 40W CRI>90
Proiettore da binario /
Tracklight
P.196



BINARI E ACCESSORI
TRACKLIGHT AND ACCESSORIES
P.198

STRISCE LED / LED STRIP



HD LED STRIP IP20 24V
Striscia LED / LED Strip
P.204



COLOR STRIP IP20 24V
Striscia LED / LED Strip
P.205



SMD LED STRIP IP20 24V
Striscia LED / LED Strip
P.206



HD LED STRIP IP54 24V
Striscia LED / LED Strip
P.207



SMD LED STRIP IP54 24V
Striscia LED / LED Strip
P.208



SMD LED STRIP IP67 24V
Striscia LED / LED Strip
P.209



CSP LED STRIP IP20 24V
Striscia LED / LED Strip
P.210



COB LED STRIP IP20 24V
Striscia LED / LED Strip
P.211



COB LED STRIP IP20 48V
Striscia LED / LED Strip
P.212



COB LED STRIP IP65 48V
Striscia LED / LED Strip
P.213



DRIVER PER STRIP LED
STRIP LED DRIVER
P.214



DIMMER PER STRIP LED
LED STRIP DIMMER
P.215



PROFILI PER STRIP LED
LED STRIP PROFILES
P.216



ACCESSORI PER STRIP LED
LED STRIP ACCESSORIES
P.218

INDICE TECNICO / TECHNICAL INDEX

MODULI LED / LED MODULES



MOD-A
Modulo led circolare
magnetico / Magnetic circular
led module
P. 222

MOD-B
Modulo led circolare
magnetico / Magnetic circular
led module
P. 223

MOD-C
Modulo led circolare
magnetico / Magnetic circular
led module
P. 224

MODULO LED SLIM
P. 225

SEGOVIA LED
Accessorio / Accessory
P. 226

LAGOS LED
Accessorio / Accessory
P. 227

REGLETTE SISTEMI COMPONIBILI / REGLETTE MODULAR SYSTEMS



EVA
Plafoniera flat Led CCT /
CCT flat Led ceiling light
P. 230

LED T5 BAR
Sistema modulare di barre
Led / Led Modular system
P. 231

YGS - Switch Fisico
Reglette Led CCT con
selettore / CCT Led reglette
with selector
P. 232

YGQ - Switch Fisico
Reglette Led CCT con
selettore / CCT Led reglette
with selector
P. 233

YGR - Switch Fisico
Led reglette CCT regolabile /
CCT adjustable Led reglette
P. 234

YGB
Sottopensile CCT /
CCT cabinet light
P. 235

PLAFONIERE STAGNE / TRI-PROOF



**PLAFONIERA STAGNA
VUOTA PER TUBI LED**
EMPTY SLIM-TRI-PROOF
FOR LED TUBES
P. 238

**PLAFONIERA STAGNA
A LED SLIM**
SLIM LED TRI-PROOF
P. 239

**PLAFONIERA STAGNA A
LED SLIM - PASSANTE**
SLIM LED TRI-PROOF
PASS THROUGH
P. 240

**PLAFONIERA STAGNA A
LED SLIM - EMERGENZA**
SLIM LED TRI-PROOF -
EMERGENCY
P. 241

**PLAFONIERA STAGNA A
LED SLIM - RADAR**
SLIM LED TRI-PROOF - RADAR
P. 242

**PLAFONIERA STAGNA A
LED SLIM LD3**
LD3 SLIM LED TRI-PROOF
P. 243

HIGH BAY



HIGH BAY LED 150
Proiettore High bay LED 150W /
High power Led high bay 150W
P. 246

HIGH BAY LED 200
Proiettore High bay LED 200W /
High power Led high bay 200W
P. 247

SS DOB HIGH BAY
Proiettore High Bay Led DOB /
DOB Led High Bay
P. 248

PROIETTORI / FLOODLIGHTS



ORLANDO 10
Proiettore a Led slim /
Slim Led floodlight
P.252



ORLANDO 20
Proiettore a Led slim /
Slim Led floodlight
P.254



ORLANDO 20 PIR
Proiettore a Led slim /
Slim Led floodlight
P.255



ORLANDO 30
Proiettore a Led slim /
Slim Led floodlight
P.256



ORLANDO 30 PIR
Proiettore a Led slim /
Slim Led floodlight
P.257



ORLANDO 50
Proiettore a Led slim /
Slim Led floodlight
P.258



ORLANDO 50 PIR
Proiettore a Led slim /
Slim Led floodlight
P.259



ORLANDO 90
Proiettore a Led slim /
Slim Led floodlight
P.260



ORLANDO 150
Proiettore a Led slim /
Slim Led floodlight
P.262



ORLANDO 200
Proiettore a Led slim /
Slim Led floodlight
P.263



KYOTO 100
Proiettore a Led
professionale / Professional
Led floodlight
P.264



KYOTO 150
Proiettore a Led
professionale / Professional
Led floodlight
P.265



KYOTO 200
Proiettore a Led
professionale / Professional
Led floodlight
P.266



KYOTO 300
Proiettore a Led
professionale / Professional
Led floodlight
P.267



KYOTO 500
Proiettore a Led
professionale / Professional
Led floodlight
P.268



ATLANTA CCT
Proiettore a Led / Led
floodlight
P.270



AKRON 2
Proiettore a Led 12/24V /
12/24V Led floodlight
P.272

INDICE RESIDENZIALE / RESIDENTIAL INDEX

INTERNI SOFFITTO / PENDANTS



LOFT35
Lampada a sospensione /
pendant lamp
P.276



SANSA
Lampada a sospensione /
pendant lamp
P.279



URBAN
Lampada a sospensione /
Pendant lamp
P.280

INDICE RESIDENZIALE / RESIDENTIAL INDEX

TAVOLO E PAVIMENTO / TABLE AND FLOOR



URBAN DESK S
Lampada da tavolo /
Table lamp
P. 284



URBAN DESK L
Lampada da tavolo /
Table lamp
P. 287



URBAN FLOOR
Lampada da terra /
Floor lamp
P. 288



CARA LED CLIP
Lampada con fissaggio a
clip / Clip wall lamp
P. 290



CARA LED WALL
Applique / Wall lamp
P. 291



CARA LED TABLE
Lampada da tavolo /
Table lamp
P. 292

LAMPADE DA TAVOLO RICARICABILI / RECHARGEABLE TABLE LAMPS



SAN
Lampada da tavolo ricaricabile
/ Rechargeable table lamp
P. 296



EMMA
Lampada da tavolo
ricaricabile / Rechargeable
table lamp
P. 298



EMMA MINI
Lampada da tavolo
ricaricabile / Rechargeable
table lamp
P. 300



MAYA
Lampada da tavolo
ricaricabile / Rechargeable
table lamp
P. 302



TAG
Lampada da tavolo
ricaricabile / Rechargeable
table lamp
P. 304



MAGNETIKA
Lampada da tavolo ricaricabile
multifunzione / Multifunction
rechargeable table lamp
P. 306



TIZIA
Lampada da tavolo ricaricabile
solare / Rechargeable table
and solar lamp
P. 308

GARDEN RESIDENZIALE / RESIDENTIAL OUTDOOR



ALICANTE
Applique / Wall lamp
P. 312

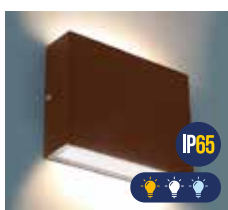

MADRID 7
Applique / Wall lamp
P. 314

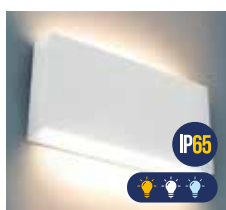

MADRID 24
Applique / Wall lamp
P. 316



NIVES 1
Applique singola emissione /
Single emission wall lamp
P. 318







































NIVES 2
Applique doppia emissione /
Double emission wall lamp
P. 320



LUNA
Applique / Wall lamp
P. 322

GARDEN RESIDENZIALE / RESIDENTIAL OUTDOOR

<p>NEW</p>  <p>NORAMINI Applique / Wall lamp P. 324</p>	 <p>MARBELLA SQUARED Applique / Wall lamp P. 326</p>	 <p>MARBELLA ROUND Applique / Wall lamp P. 327</p>	 <p>MARBELLA BIG SQUARED Applique / Wall lamp P. 328</p>	 <p>MARBELLA DUO Applique / Wall lamp P. 330</p>	<p>NEW</p>  <p>RONDA Plafoniera / Ceiling light P. 332</p>
 <p>MALAGA Plafone / Ceiling lamp P. 334</p>	 <p>ALMERIA Plafone / Ceiling lamp P. 335</p>	 <p>TOLEDO 1 Applique singola emissione / Single emission wall lamp P. 336</p>	 <p>TOLEDO 2 Applique doppia emissione / Double emission wall lamp P. 337</p>	 <p>TOLEDO 10 Applique / Wall lamp P. 338</p>	 <p>SUND Applique singola emissione / Single emission wall lamp P. 340</p>
 <p>SUND DUO Applique doppia emissione / Double emission wall lamp P. 341</p>	 <p>CORDOVA 1 Applique singola emissione / Single emission wall lamp P. 342</p>	 <p>CORDOVA 2 Applique doppia emissione / Double emission wall lamp P. 343</p>	 <p>CORDOVA 10 Applique / Wall lamp P. 344</p>	 <p>AVILA Applique con sensore crepuscolare / Wall light with dusk sensor P. 346</p>	 <p>ALPPILA 1S Applique singola emissione / Single emission wall lamp P. 348</p>
 <p>ALPPILA 2S Applique doppia emissione / Double emission wall lamp P. 349</p>	 <p>ALPPILA XL Applique doppia emissione / Double emission wall lamp P. 350</p>	 <p>GRANADA Applique doppia emissione / Double emission wall lamp P. 351</p>	 <p>GRANADA2 Applique singola emissione / Single emission wall lamp P. 352</p>	 <p>GRANADA2 DUO Applique doppia emissione / Double emission wall lamp P. 353</p>	<p>NEW</p>  <p>BARREL Lanterna da muro / Wall mounted lantern P. 354</p>
<p>NEW</p>  <p>JEREZ Applique / Wall lamp P. 356</p>	 <p>ARVIKA Applique / Wall lamp P. 357</p>	 <p>MAIORCA Applique / Wall lamp P. 358</p>	 <p>SEGOVIA 1 Applique / Wall lamp P. 360</p>	 <p>LAGOS 1 Applique / Wall lamp P. 362</p>	 <p>LAGOS 2 Applique / Wall lamp P. 364</p>
 <p>VALENCIA Applique / Wall lamp P. 366</p>	<p>NEW</p>  <p>VALENCIA 2 Applique doppia emissione / Double emission wall lamp P. 368</p>	 <p>VIGO 1 Applique / Wall lamp P. 370</p>	 <p>VIGO 2 Applique / Wall lamp P. 371</p>	 <p>VIGO 3 Applique / Wall lamp P. 372</p>	 <p>VIGO 4 Applique / Wall lamp P. 373</p>

INDICE RESIDENZIALE / RESIDENTIAL INDEX

GARDEN RESIDENZIALE / RESIDENTIAL OUTDOOR



CADICE
Applique / Wall lamp
P.376



CADICE BOLLARD
Paletto da giardino /
Outdoor bollard
P.377



KALLIO
Paletto da giardino /
Outdoor bollard
P.378



IBIZA
Paletto da giardino /
Outdoor bollard
P.380



MERIDA
Paletto da giardino /
Outdoor bollard
P.381



LEON P
Lanterna con paletto /
Lantern lamp with pole
P.382



LEON
Lanterna / Lantern lamp
P.383



LEON 12 FRAME
Lanterna da muro /
Wall mounted lantern
P.384

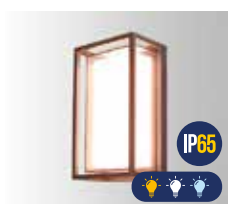

LEON 12
Lanterna da muro /
Wall mounted lantern
P.386



LEON 2
Plafoniera / Ceiling lamp
P.388



SPIKY1
Picchetto da giardino /
Outdoor stake light
P.390



SPIKY2
Picchetto da giardino /
Outdoor stake light
P.391



SPIKY3
Picchetto da giardino
regolabile / Adjustable
outdoor stake light
P.392



ARONA 1
Segnapasso CCT /
CCT step light
P.394



ARONA 2
Segnapasso CCT /
CCT step light
P.395



ARONA 3
Segnapasso CCT /
CCT step light
P.396



BILBAO 3 SQUARED
Segnapasso CCT / CCT
step light
P.398



BILBAO 6 SQUARED
Segnapasso CCT / CCT
step light
P.399



SORIA RETTANGOLARE
Segnapasso CCT /
CCT step light
P.400



SORIA QUADRATO
Segnapasso CCT /
CCT step light
P.401



ARONA 200
Segnapasso CCT per cover
magnetica / CCT step light
for magnetic cover
P.402

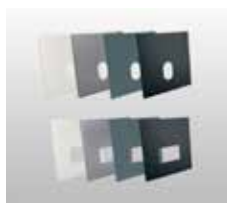

COVER ARONA 200
Cover magnetiche
Magnetic covers
P.402



ARONA 300
Segnapasso CCT per cover
magnetica / CCT step light
for magnetic cover
P.403



COVER ARONA 300
Cover magnetiche
Magnetic covers
P.403



HOLM
Segnapasso calpestabile /
Walkover light
P.406



AITONA
Segnapasso calpestabile /
Walkover light
P.408



GARDA DESK
Lampada da tavolo per
esterni / Outdoor table lamp
P.410



GARDA FLOOR
Lampada da terra per
esterni / Outdoor floor lamp
P.412

SOLARE TECNICO / TECHNICAL SOLAR



KALAP
Lampione solare /
Solar street light
P.416



YUMA1500NK
Proiettore solare con pannello
separato / Solar floodlight with
separate panel
P.418



YUMA2800NK
Proiettore solare con pannello
separato / Solar floodlight with
separate panel
P.419



YUMA4800NK
Proiettore solare con pannello
separato / Solar floodlight with
separate panel
P.420



YUMA11NK
Proiettore solare stradale/
Street solar floodlight
P.422



YUMA15NK
Proiettore solare stradale/
Street solar floodlight
P.424



YUMA40NK
Proiettore solare stradale/
Street solar floodlight
P.426

SOLARE RESIDENZIALE / RESIDENTIAL SOLAR



INCLINE2N
Proiettore solare /
Solar floodlight
P.430



INCLINE4N
Proiettore solare /
Solar floodlight
P.431



INCLINE8N
Proiettore solare /
Solar floodlight
P.432



YUMA2N
Proiettore solare /
Solar floodlight
P.434



YUMA8NP
Proiettore e picchetto solare
/ Solar and stake light
P.435



YUMA6NK
Proiettore solare /
Solar floodlight
P.436



YUMA10NK
Proiettore solare / Solar
floodlight
P.437



MARBELLA10SUN
Applique solare /
Solar wall lamp
P.438



MARBELLA POLE & SPIKE
Paletto per / Pole for
MARBELLA10SUN
P.438



MARBELLA9SUN
Applique solare /
Solar wall lamp
P.440



MARBELLA POLE & SPIKE
Paletto per / Pole for
MARBELLA9SUN
P.440



YUMA350P
Palo solare da giardino /
Garden solar bollard light
P.442



YUMA1200P
Palo solare da giardino /
Garden solar bollard light
P.444



CLAY
Applique solare /
Solar wall lamp
P.446



AVENUE
Applique solare /
Solar wall lamp
P.448



MOON
Applique solare /
Solar wall lamp
P.450



YUCCA
Lanterna solare /
Solar lantern
P.452



YUCCAP
Lanterna solare con paletto/
Solar lantern with pole
P.454



FLAME2N
Torcia a Led effetto fiamma -
solare / Led torch with flame
effect - solar powered
P.456

INDICE PORTATILI E LEISURE / PORTABLE AND LEISURE INDEX

WORKLIGHTS

 <p>NEW</p> <p>IK08 IP54</p>	 <p>NEW</p> <p>IK08 IP54</p>	 <p>NEW</p> <p>IK08 IP54</p>	 <p>IK08 IP54</p>	 <p>NEW</p>	
<p>WORK 50 Lampada da lavoro portatile / Portable worklight P. 460</p>	<p>WORK 10 Proiettore portatile / Worklight P. 462</p>	<p>WORK 20 Lampada da lavoro portatile / Portable worklight P. 463</p>	<p>FROG Proiettore multiuso ricaricabile / Rechargeable multipurpose worklight P.464</p>	<p>LED16 Flashlight torcia portatile a led ricaricabile / Portable Rechargeable LED Torch P.466</p>	<p>EXPO WORKLIGHT LED COLORI VARI 9 PZ P.467</p>

FLASHLIGHT & SPOTLIGHTS

 <p>LED BICYCLE FRONT LIGHT P.470</p>	 <p>LED BICYCLE LIGHT SET CON RICARICA USB P.470</p>	 <p>LED BICYCLE REAR RED LIGHT P.470</p>	 <p>LED BICYCLE REAR RED LIGHT TARO P.471</p>	 <p>AIRAM HEADLIGHT P.471</p>	 <p>AIRAM POWER HEADLIGHT P.471</p>
 <p>MAX 800 TORCIA LED FLASHLIGHT 800LM RICARICA USB P.472</p>	 <p>EXPO CLIPPY SAFETY LIGHT LED 12 PZ P.472</p>	 <p>EXPO TORCE LED COLORI VARI 12 PZ P.472</p>	 <p>EXPO TORCE LED13 COLORI VARI 12 PZ P.473</p>		

PILE / BATTERIES

 <p>EVOLUTION + ALKALINE P.474</p>	 <p>SUPER ALKALINE MULTIPACK P.474</p>	 <p>ALKALINE P.475</p>	 <p>LITHIUM P.475</p>
---	--	--	--

NIGHTLIGHTS



**LUCE NOTTURNA POWER
LED CREPUSCOLARE**
P.477



**LUCE NOTTURNA POWER
LED CREPUSCOLARE +
SENSOR**
P.477



**LUCE NOTTURNA POWER
LED CREPUSCOLARE
ROUND**
P.477



**LAMPADA DA ARMADIO
CON SENSORE DI
MOVIMENTO**
P.477

SHOT

BOT LIGHTING

LA TUA LUCE PERSONALIZZABILE YOUR CUSTOMIZABLE LIGHT



CREA LA TUA ATMOSFERA / CREATE YOUR ATMOSPHERE
Personalizza i tuoi ambienti con **16 milioni di combinazioni di colori**.
Customize your spaces with 16 million color combinations.



DANZA CON LE LUCI / DANCE WITH THE LIGHTS
Crea un'atmosfera di relax o cambia le luci a ritmo della tua musica preferita.
Create a relaxing atmosphere or change the lights to the rhythm of your favorite music.



PERSONALIZZABILE / CUSTOMIZABLE
Imposta le tue luci tramite app Tuya e gli assistenti vocali più noti sul mercato.
Set your lights via the Tuya app and the most popular voice assistants on the market.



GESTIONE SCENARI / SCENE MANAGEMENT
Crea la tua scena per ogni situazione.
Create your own scene for every situation.



TUNABLE WHITE 2700-6500K
Bianco più fedele grazie alla combinazione di 2 tonalità di bianco.
More accurate white thanks to the combination of 2 shades of white.

RGB

RGB COLOURS
LED RGB per il controllo completo del colore.
RGB LED for complete color control.



ALEXA E GOOGLE ASSISTANT
Gestisci le luci con le skill dei tuoi assistenti digitali preferiti.
Manage your lights with the skills of your favorite digital assistants.



TUYA SYSTEM
Controlla tutti i tuoi dispositivi preferiti all'interno della piattaforma Tuya.
Control all your favorite devices within the Tuya platform.

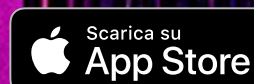

Powered by

tuya

Intelligence
Inside

PER LA QUALITÀ DELLA VITA / FOR QUALITY OF LIFE

Luci Basate sul Bioritmo.

La temperatura di colore e la dimmerazione si adattano automaticamente al ritmo circadiano, ideale per chi lavora.

Lights Based on Biorhythm.

Color temperature and dimming adjust to the circadian rhythm, ideal for workers.

PROGRAMMAZIONE QUOTIDIANA / MODALITÀ SLEEP & WAKE UP

Accendi e dimmera le luci automaticamente con timer nei giorni prestabiliti.

Daily Programming / Sleep & Wake Up Mode

Automatically turn on and dim the lights with a timer on preset days.

PER LA SICUREZZA / FOR YOUR SECURITY

Arrivo e Uscita - Geolocalizzazione.

Gestione automatica delle luci quando entri o esci di casa tramite geolocalizzazione.

Coming & Leaving Home - Geolocation.

Automatic light management when you enter or leave your house via geolocation.

INTEGRAZIONE CON SENSORI DI MOVIMENTO / INTEGRATION WITH MOTION SENSORS

Controlla le luci con sensori di movimento e accensione casuale per simulare la tua presenza.

Control lights with motion sensors and randomly turn them on to simulate your presence.



GOCCIA STICK SMART A60 TUNABLE WHITE 220-240V

BTL CATEGORIA SCONTO 21

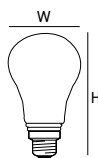

_ Personalizzabile: imposta le tue luci tramite app Tuya e gli assistenti vocali più noti nel mercato.

_ Customizable: set your lights via Tuya app and the most popular voice assistants in the market.



W



BASE

K

lm



H x W
mm

CODICE

EAN



6,5

60

E27

2700
6500

806

330°

108x60

A60WT60TW-S

8031453024413

10/50





GOCCIA OPALE SMART RGB + TUNABLE WHITE 220-240V

BTL CATEGORIA SCONTO 21

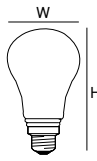

_ Personalizzabile: imposta le tue luci tramite app Tuya e gli assistenti vocali piu' noti nel mercato.

_ Customizable: set your lights via Tuya app and the most popular voice assistants in the market.



W	W=	BASE	K	lm		H x W mm	CODICE	EAN		
10,0	75	E27	2700 6500	1055	220°	120x60	A60WT75RTW	8031453024406	10/50	



SFERA OPALE SMART RGB + TUNABLE WHITE 220-240V

BTL CATEGORIA SCONTO 21

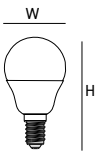

_ Personalizzabile: imposta le tue luci tramite app Tuya e gli assistenti vocali piu' noti nel mercato.

_ Customizable: set your lights via Tuya app and the most popular voice assistants in the market.



W	W=	BASE	K	lm		H x W mm	CODICE	EAN		
4,9	40	E14	2700 6500	470	180°	90x45	P45WT40RTW	8031453025311	10/100	



OLIVA OPALE SMART RGB + TUNABLE WHITE 220-240V

BTL CATEGORIA SCONTO 21

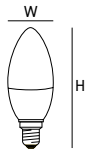

_ Personalizzabile: imposta le tue luci tramite app Tuya e gli assistenti vocali piu' noti nel mercato.

_ Customizable: set your lights via Tuya app and the most popular voice assistants in the market.



W	W=	BASE	K	lm		H x W mm	CODICE	EAN		
5,0	40	E14	2700 6500	470	200°	115x39	C37WT40RTW	8031453024420	10/100	

GLOBO 95 OPALE SMART RGB + TUNABLE WHITE 220-240V

BTL CATEGORIA SCONTO 21

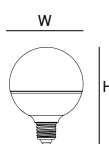

_ Personalizzabile: imposta le tue luci tramite app Tuya e gli assistenti vocali piu' noti nel mercato.

_ Customizable: set your lights via Tuya app and the most popular voice assistants in the market.



W	W=	BASE	K	lm		H x W mm	CODICE	EAN		
12,0	100	E27	 2700 6500	1521	180°	137x95	D95WT100RTW	8031453025304	10/50	



REFLECTOR R80 OPALE SMART RGB + TUNABLE WHITE 220-240V

BTL CATEGORIA SCONTO 21

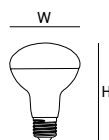

_ Personalizzabile: imposta le tue luci tramite app Tuya e gli assistenti vocali piu' noti nel mercato.

_ Customizable: set your lights via Tuya app and the most popular voice assistants in the market.



W	W=	BASE	K	lm		H x W mm	CODICE	EAN		
8,5	60	E27	 2700 6500	806	180°	115x80	R80WT60RTW	8031453025298	10/50	



GU10 SMART RGB + TUNABLE WHITE 220-240V

BTL CATEGORIA SCONTO 21

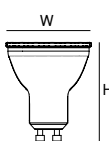

_ Personalizzabile: imposta le tue luci tramite app Tuya e gli assistenti vocali piu' noti nel mercato.

_ Customizable: set your lights via Tuya app and the most popular voice assistants in the market.



W	W=	BASE	K	lm		H x W mm	CODICE	EAN		
5,0	32	GU10	 2700 6500	350	100°	58x50	GU10WT35RTW	8031453024437	10/100	

SHOT

BOT LIGHTING

SORGENTI ULTRA EFFICIENTI IN NUOVA CLASSE A ULTRA EFFICIENT SOURCES IN NEW A CLASS

Bot Lighting introduce la nuova gamma di sorgenti luminose ultra efficienti in classe A, consentendo a consumatori e professionisti di ottenere risparmi energetici fino al 45% rispetto alle sorgenti LED di ultima generazione. Si tratta di una rivoluzione tecnologica che sta per cominciare!

Bot Lighting introduces its new range of ultra-efficient light sources in class A, enabling consumers and professionals to achieve energy savings of up to 45% compared to the latest generation of LED sources. A technological revolution is about to begin!



ALTA EFFICIENZA

Queste nuove sorgenti offrono una efficienza di oltre 210 lm/W.

HIGH EFFICIENCY

These new light sources offer an efficiency of over 210 lm/W.



MINORI CONSUMI

I consumi si riducono fino al 45% rispetto alle precedenti lampadine LED Botlighting, con minori emissioni di CO₂.

LESS CONSUMPTION

Consumption is reduced by up to 45% compared to previous Botlighting LED bulbs, resulting in significant lower CO₂ emissions.



PROGETTATE PER DURARE

Le nuove sorgenti in classe A sono progettate per un utilizzo duraturo. Questo riduce anche la produzione di rifiuti elettronici (RAEE) a tutto vantaggio dell'ambiente.

DESIGN TO LAST

The new class A light sources are designed for long-lasting use. This also reduces electronic waste (WEEE), benefiting the environment.

CRI > 80

QUALITA' E COMFORT VISIVO

Le sorgenti luminose non hanno componenti verdastre, garantendo un comfort visivo ottimale in ogni situazione.

QUALITY AND VISUAL COMFORT

The light sources have no greenish components, ensuring optimal visual comfort in every situation.



GOCCIA LED STICK H
p. 40



SFERA LED STICK H
p. 40



OLIVA LED STICK H
p. 41



GLOBO 125 LED STICK H
p. 41



LED GU10 H
p. 90-92



**TUBO LED VETRO T8
A-CLASS**
p. 114

***BOTLIGHTING: DA SEMPRE ATTENTA ALL'AMBIENTE
MENO CONSUMI = MINORE INQUINAMENTO AMBIENTALE.***

*BOT LIGHTING AND THE ENVIRONMENT
LESS CONSUMPTION = LESS ENVIRONMENTAL POLLUTION.*

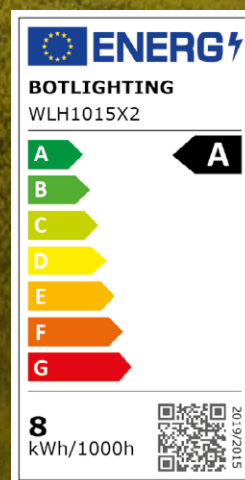

GOCCIA LED STICK H 220-240V

BTL CATEGORIA SCONTO 21

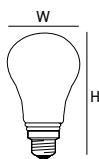

IP 20

50.000 h

25.000



W	W=	BASE	K	lm		H x W mm	CODICE	EAN		
3,8	60	E27	3000	806	330°	108x60	WLH1008X2	8031453028046	10/50	
3,8	60	E27	4000	806	330°	108x60	WLH1008X3	8031453029159	10/50	
5,0	75	E27	3000	1055	330°	108x60	WLH1010X2	8031453029166	10/50	
5,0	75	E27	4000	1055	330°	108x60	WLH1010X3	8031453029173	10/50	
7,2	100	E27	3000	1521	330°	108x60	WLH1015X2B	8031453029180	10/50	
7,2	100	E27	4000	1521	330°	108x60	WLH1015X3B	8031453029197	10/50	
7,2	100	E27	3000	1521	330°	126x70	WLH1015X2	8031453028053	10/50	

SFERA LED STICK H 220-240V

BTL CATEGORIA SCONTO 21

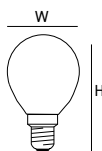

IP 20

50.000 h

25.000



W	W=	BASE	K	lm		H x W mm	CODICE	EAN		
2,2	40	E14	3000	470	330°	80x45	WLH3004X2	8031453029241	10/50	
2,2	40	E14	4000	470	330°	80x45	WLH3004X3	8031453029258	10/50	
3,8	60	E14	3000	806	330°	80x45	WLH3008X2	8031453029265	10/50	
3,8	60	E14	4000	806	330°	80x45	WLH3008X3	8031453029272	10/50	

OLIVA LED STICK H 220-240V

BTL CATEGORIA SCONTO 21

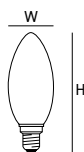

W	W=	BASE	K	lm		H x W mm	CODICE	EAN		
2.2	40	E14	3000	470	330°	97x35	WLH2004X2	8031453029203	10/50	A
2.2	40	E14	4000	470	330°	97x35	WLH2004X3	8031453029210	10/50	A
3.8	60	E14	3000	806	330°	97x35	WLH2008X2	8031453029227	10/50	A
3.8	60	E14	4000	806	330°	97x35	WLH2008X3	8031453029234	10/50	A

GLOBO 125 LED STICK H 220-240V

BTL CATEGORIA SCONTO 21

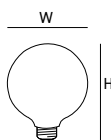

W	W=	BASE	K	lm		H x W mm	CODICE	EAN		
7.2	100	E27	3000	1521	330°	178x125	WLH4015X2	8031453029289	5/20	A
7.2	100	E27	4000	1521	330°	178x125	WLH4015X3	8031453029296	5/20	A

SHOT

BOT LIGHTING

LAMPADE LED FILAMENTO BIANCO WHITE FILAMENT LED BULBS

IDEALI PER AMBIENTI DI DESIGN

Belle anche da spente, le lampade a filamento bianco di ultima generazione sono progettate per i tuoi apparecchi dal design minimalista e moderno per un'atmosfera elegante e pulita.

IDEAL FOR DESIGN ENVIRONMENTS

Beautiful even when switched off, the latest generation white filament light bulbs are designed for your luminaires with a minimalist and modern look for an elegant and clean atmosphere.





GOCCIA WHITE FILAMENT 220-240V

BTL CATEGORIA SCONTO 21

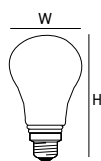

IP 20

20.000h

20.000



W	W=	BASE	K	lm		H x W mm	CODICE	EAN		
7,0	60	E27	3000	806	330°	108x60	WLW1008X2BB	8031453029302	10/50	
7,0	60	E27	4000	806	330°	108x60	WLW1008X3	8031453030803	10/50	
8,5	75	E27	3000	1055	330°	108x60	WLW1010X2BB	8031453029319	10/50	
8,5	75	E27	4000	1055	330°	108x60	WLW1010X3	8031453030810	10/50	
10,5	100	E27	3000	1521	330°	108x60	WLW1015X2BB	8031453029326	10/50	
10,5	100	E27	4000	1521	330°	108x60	WLW1015X3	8031453030827	10/50	



SFERA WHITE FILAMENT 220-240V

BTL CATEGORIA SCONTO 21

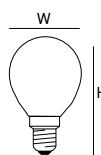

IP 20

20.000h

20.000



W	W=	BASE	K	lm		H x W mm	CODICE	EAN		
4,5	40	E14	3000	470	330°	80x45	WLW3004X2BB	8031453030926	10/50	
4,5	40	E14	4000	470	330°	80x45	WLW3004X3	8031453030933	10/50	



OLIVA WHITE FILAMENT 220-240V

BTL CATEGORIA SCONTO 21

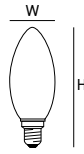

IP 20

h
20.000

20.000



W	W=	BASE	K	lm		H x W mm	CODICE	EAN		
2,5	25	E14	3000	250	330°	97x35	WLW2002X2BB	8031453029333	10/50	F
2,5	25	E14	4000	250	330°	97x35	WLW2002X3	8031453030834	10/50	F
4,5	40	E14	3000	470	330°	97x35	WLW2004X2BB	8031453029340	10/50	F
4,5	40	E14	4000	470	330°	97x35	WLW2004X3	8031453030841	10/50	F
6,5	60	E14	3000	806	330°	97x35	WLW2008X2BB	8031453029357	10/50	E
6,5	60	E14	4000	806	330°	97x35	WLW2008X3	8031453030858	10/50	E



GLOBO WHITE FILAMENT 220-240V

BTL CATEGORIA SCONTO 21

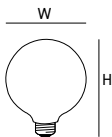

IP 20

h
20.000

20.000



W	W=	BASE	K	lm		H x W mm	CODICE	EAN		
2,5	25	E27	3000	250	330°	178x125	WLW4002X2BB	8031453029364	5/20	F
2,5	25	E27	4000	250	330°	178x125	WLW4002X3	8031453030865	5/20	F
10,5	100	E27	3000	1521	330°	178x125	WLW4015X2BB	8031453029371	5/20	D
10,5	100	E27	4000	1521	330°	178x125	WLW4015X3	8031453030872	5/20	D



SHOT
BOT LIGHTING

LAMPADE LED STICK
LED STICK BULBS



GOCCIA LED STICK CRI >95 220-240V

BTL CATEGORIA SCONTO 21

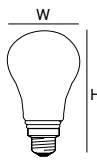

W	W=	BASE	K	lm		H x W mm	CODICE	EAN		
7,5	60	E27	2700	806	330°	108x60	WLD1008X29	8031453021290	10/50	
8,0	75	E27	2700	1055	330°	108x60	WLD1010X29	8031453021306	10/50	
11,0	100	E27	2700	1521	330°	126x70	WLD1011X29	8031453021313	10/50	

SFERA LED STICK CRI>95 220-240V

BTL CATEGORIA SCONTO 21

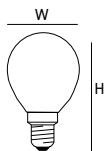

W	W=	BASE	K	lm		H x W mm	CODICE	EAN		
5,0	40	E14	2700	470	330°	80x45	WLD3004X29	8031453021337	10/50	
5,0	40	E27	2700	470	330°	78x45	WLD3104X29	8031453021344	10/50	

OLIVA LED STICK CRI >95 220-240V

BTL CATEGORIA SCONTO 21

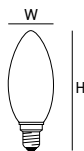

W	W=	BASE	K	lm		H x W mm	CODICE	EAN		
5,0	40	E14	2700	470	330°	97x35	WLD2004X29	8031453021320	10/50	

GOCCIA LED STICK DIMMERABLE 220-240V

BTL CATEGORIA SCONTO 21

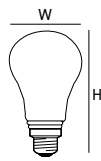

W	W=	BASE	K	lm		H x W mm	CODICE	EAN		
7,0	60	E27	2700	806	330°	108x60	WLD1008X2D	8031453017750	10/50	
7,0	60	E27	4000	806	330°	108x60	WLD1008X3D	8031453023980	10/50	
9,0	75	E27	2700	1055	330°	108x60	WLD1010X2D	8031453020958	10/50	
9,0	75	E27	4000	1055	330°	108x60	WLD1010X3D	8031453023997	10/50	
11,0	100	E27	2700	1521	330°	108x60	WLD1011X2D	8031453024000	10/50	
11,0	100	E27	4000	1521	330°	108x60	WLD1011X3D	8031453024017	10/50	

SFERA LED STICK DIMMERABLE 220-240V

BTL CATEGORIA SCONTO 21

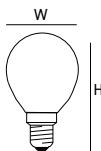

W	W=	BASE	K	lm		H x W mm	CODICE	EAN		
4,5	40	E14	2700	470	330°	80x45	WLD3004X2D	8031453020989	10/50	
4,5	40	E14	4000	470	330°	80x45	WLD3004X3D	8031453024024	10/50	
5,9	60	E14	2700	806	330°	80x45	WLD3006X2D	8031453027278	10/50	
6,0	60	E27	2700	806	330°	78x45	WLD3106X2D	8031453020996	10/50	
6,5	60	E27	4000	806	330°	78x45	WLD3106X3D	8031453024031	10/50	

OLIVA LED STICK DIMMERABILE 220-240V

BTL CATEGORIA SCONTO 21

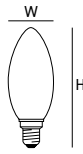

IP 20 20.000h 20.000

W	W=	BASE	K	lm		H x W mm	CODICE	EAN		
4,5	40	E14	2700	470	330°	97x35	WLD2004X2D	8031453019372	10/50	
4,5	40	E14	4000	470	330°	97x35	WLD2004X3D	8031453024048	10/50	
5,9	60	E14	2700	806	330°	97x35	WLD2006X2D	8031453027261	10/50	

OLIVA LED STICK SATINATA DIMMERABILE 220-240V

BTL CATEGORIA SCONTO 21



IP 20 20.000h 20.000

W	W=	BASE	K	lm		H x W mm	CODICE	EAN		
4,5	40	E14	2700	470	330°	97x35	WLD2004X2SD	8031453019389	10/50	

GLOBO 125 LED STICK DIMMERABLE 220-240V

BTL CATEGORIA SCONTO 21

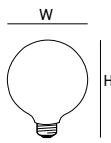

W	W=	BASE	K	lm		H x W mm	CODICE	EAN		
2,5	25	E27	2700	250	330°	178x125	WLD4002X2D	8031453017811	5/20	
7,0	60	E27	2700	806	330°	178x125	WLD4008X2D	8031453017781	5/20	
7,0	60	E27	4000	806	330°	178x125	WLD4008X3D	8031453024055	5/20	
11,0	100	E27	2700	1521	330°	178x125	WLD4013X2D	8031453020965	5/20	
11,0	100	E27	4000	1521	330°	178x125	WLD4013X3D	8031453024062	5/20	

GLOBO 125 LED SPRING DIMMERABLE 220-240V

BTL CATEGORIA SCONTO 21

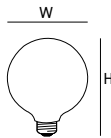

W	W=	BASE	K	lm		H x W mm	CODICE	EAN		
5,0	28	E27	1800	300	330°	178x125	WLD4005X2HSDW	8031453024659	5/20	-
5,0	35	E27	2700	400	330°	178x125	WLD4005X2HSD	8031453024642	5/20	

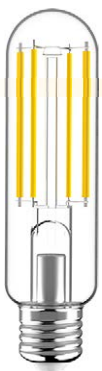
TUBOLARE T38 LED STICK DIMMERABLE 220-240V
NEW

BTL CATEGORIA SCONTO 21



W	W=	BASE	K	lm		H x W mm	CODICE	EAN		
14,0	145	E27	3000	2350	330°	150x38	WLD7814X2BBD	8031453032739	10/50	



GOCCIA LED STICK 220-240V

BTL CATEGORIA SCONTO 21

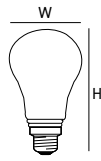

IP 20

20.000 h

20.000



W	W=	BASE	K	lm		H x W mm	CODICE	EAN		
4,5	40	E27	2700	470	330°	108x60	WLD1004X2	8031453008086	10/50	
7,0	60	E27	2700	806	330°	108x60	WLD1008X2	8031453011918	10/50	
7,0	60	E27	3000	806	330°	108x60	WLD1008X2BB	8031453027926	10/50	
7,0	60	E27	4000	806	330°	108x60	WLD1008X3	8031453017026	10/50	
7,0	60	E27	6500	806	330°	108x60	WLD1008X1	8031453016999	10/50	
8,5	75	E27	2700	1055	330°	108x60	WLD1010X2	8031453014599	10/50	
8,5	75	E27	3000	1055	330°	108x60	WLD1010X2BB	8031453027933	10/50	
8,5	75	E27	4000	1055	330°	108x60	WLD1010X3	8031453016937	10/50	
8,5	75	E27	6500	1055	330°	108x60	WLD1010X1	8031453016968	10/50	
10,5	100	E27	2700	1521	330°	108x60	WLD1011X2	8031453016609	10/50	
10,5	100	E27	3000	1521	330°	108x60	WLD1011X2BB	8031453027940	10/50	
10,5	100	E27	4000	1521	330°	108x60	WLD1011X3	8031453016876	10/50	
10,5	100	E27	6500	1521	330°	108x60	WLD1011X1	8031453016906	10/50	
18,0	150	E27	2700	2452	330°	126x70	WLD1016X2	8031453021436	10/50	
18,0	150	E27	4000	2452	330°	126x70	WLD1016X3	8031453021443	10/50	
18,0	150	E27	6500	2452	330°	126x70	WLD1016X1	8031453021429	10/50	

SFERA LED STICK 220-240V

BTL CATEGORIA SCONTO 21

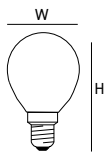

IP 20

20.000

20.000



W	W=	BASE	K	lm		H x W mm	CODICE	EAN		
1,4	15	E14	2700	136	330°	80x45	WLD3001X2	8031453027407	10/50	
2,5	25	E14	2700	250	330°	80x45	WLD3002X2	8031453008413	10/50	
4,5	40	E14	2700	470	330°	80x45	WLD3004X2	8031453008444	10/50	
4,5	40	E14	3000	470	330°	80x45	WLD3004X2BB	8031453027988	10/50	
4,5	40	E14	4000	470	330°	80x45	WLD3004X3	8031453016746	10/50	
4,5	40	E14	6500	470	330°	80x45	WLD3004X1	8031453016777	10/50	
6,5	60	E14	2700	806	330°	80x45	WLD3006X2	8031453021184	10/50	
6,5	60	E14	3000	806	330°	80x45	WLD3006X2BB	8031453027995	10/50	
6,5	60	E14	4000	806	330°	80x45	WLD3006X3	8031453021191	10/50	
7,0	75	E14	2700	1055	330°	80x45	WLD3007X2	8031453028114	10/50	
7,0	75	E14	3000	1055	330°	80x45	WLD3007X2BB	8031453028121	10/50	
7,0	75	E14	4000	1055	330°	80x45	WLD3007X3	8031453028138	10/50	
1,4	15	E27	2700	136	330°	78x45	WLD3101X2	8031453027414	10/50	
2,5	25	E27	2700	250	330°	78x45	WLD3102X2	8031453027421	10/50	
4,5	40	E27	2700	470	330°	78x45	WLD3104X2	8031453016630	10/50	
4,5	40	E27	3000	470	330°	78x45	WLD3104X2BB	8031453028008	10/50	
4,5	40	E27	4000	470	330°	78x45	WLD3104X3	8031453016685	10/50	
4,5	40	E27	6500	470	330°	78x45	WLD3104X1	8031453016715	10/50	
6,5	60	E27	2700	806	330°	78x45	WLD3106X2	8031453021207	10/50	
6,5	60	E27	3000	806	330°	78x45	WLD3106X2BB	8031453028015	10/50	
6,5	60	E27	4000	806	330°	78x45	WLD3106X3	8031453021252	10/50	
7,0	75	E27	2700	1055	330°	78x45	WLD3107X2	8031453028145	10/50	
7,0	75	E27	3000	1055	330°	78x45	WLD3107X2BB	8031453028152	10/50	
7,0	75	E27	4000	1055	330°	78x45	WLD3107X3	8031453028169	10/50	

OLIVA LED STICK 220-240V

BTL CATEGORIA SCONTO 21



W	W=	BASE	K	lm		H x W mm	CODICE	EAN		
2,5	25	E14	2700	250	330°	97x35	WLD2002X2	8031453008352	10/50	
2,5	25	E14	3000	250	330°	97x35	WLD2002X2BB	8031453027957	10/50	
2,5	25	E14	4000	250	330°	97x35	WLD2002X3	8031453019327	10/50	
4,5	40	E14	2700	470	330°	97x35	WLD2004X2	8031453008383	10/50	
4,5	40	E14	3000	470	330°	97x35	WLD2004X2BB	8031453027964	10/50	
4,5	40	E14	4000	470	330°	97x35	WLD2004X3	8031453016814	10/50	
4,5	40	E14	6500	470	330°	97x35	WLD2004X1	8031453016845	10/50	
6,5	60	E14	2700	806	330°	97x35	WLD2006X2	8031453021160	10/50	
6,5	60	E14	3000	806	330°	97x35	WLD2006X2BB	8031453027971	10/50	
6,5	60	E14	4000	806	330°	97x35	WLD2006X3	8031453021177	10/50	
7,0	75	E14	2700	1055	330°	97x35	WLD2007X2	8031453028084	10/50	
7,0	75	E14	3000	1055	330°	97x35	WLD2007X2BB	8031453028091	10/50	
7,0	75	E14	4000	1055	330°	97x35	WLD2007X3	8031453028107	10/50	

TORTIGLIONE LED STICK 220-240V

BTL CATEGORIA SCONTO 21



W	W=	BASE	K	lm		H x W mm	CODICE	EAN		
2,5	25	E14	2700	250	330°	97x35	WLD2002T2	8031453025229	10/50	
4,5	40	E14	2700	470	330°	97x35	WLD2004T2	8031453023393	10/50	
4,5	40	E14	4000	470	330°	97x35	WLD2004T3	8031453023409	10/50	

FIAMMA LED STICK 220-240V

BTL CATEGORIA SCONTO 21



IP 20

h
20.000

20.000



W	W=	BASE	K	lm		H x W mm	CODICE	EAN		
4,5	40	E14	2700	470	330°	123x35	WLD2004F2	8031453023379	10/50	
4,5	40	E14	4000	470	330°	123x35	WLD2004F3	8031453023386	10/50	

GLOBO 95 LED STICK 220-240V AGGIORNATO

BTL CATEGORIA SCONTO 21

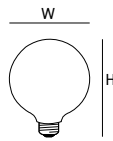

W	W=	BASE	K	lm		H x W mm	CODICE	EAN			
7,0	60	E27	2700	806	330°	140x95	WLD4208X2	8031453019983	5/20		
8,5	75	E27	2700	1055	330°	140x95	WLD4210X2	8031453019990	5/20		
8,5	75	E27	4000	1055	330°	140x95	WLD4210X3	8031453027650	5/20		
10,5	100	E27	2700	1521	330°	140x95	WLD4215X2	8031453033453	5/20		NEW

GLOBO 125 LED STICK 220-240V

BTL CATEGORIA SCONTO 21

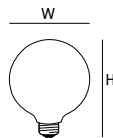

W	W=	BASE	K	lm		H x W mm	CODICE	EAN			
2,5	25	E27	2700	250	330°	178x125	WLD4002X2	8031453008147	5/20		
4,5	40	E27	2700	470	330°	178x125	WLD4004X2	8031453008178	5/20		
7,0	60	E27	2700	806	330°	178x125	WLD4008X2	8031453014650	5/20		
8,5	75	E27	2700	1055	330°	178x125	WLD4010X2	8031453011369	5/20		
8,5	75	E27	4000	1055	330°	178x125	WLD4010X3	8031453019402	5/20		
11,0	100	E27	2700	1521	330°	178x125	WLD4011X2	8031453019792	5/20		
11,0	100	E27	4000	1521	330°	178x125	WLD4011X3	8031453019808	5/20		

PICCOLA PERA LED STICK 220-240V

BTL CATEGORIA SCONTO 21

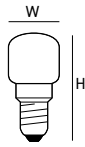

IP 20

20.000h

20.000



W	W=	BASE	K	lm		H x W mm	CODICE	EAN		
1,5	15	E14	2700	140	330°	56x20	WLD7301X2	8031453024277	10/50	
1,5	15	E14	4000	140	330°	56x20	WLD7301X3	8031453024284	10/50	
1,5	15	E14	6500	140	330°	56x20	WLD7301X1	8031453024260	10/50	
2,5	25	E14	2700	250	330°	61x26	WLD7102X2	8031453020378	10/50	

TUBOLARE T20 LED STICK 220-240V

BTL CATEGORIA SCONTO 21

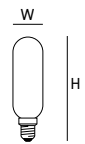

IP 20

20.000h

20.000



W	W=	BASE	K	lm		H x W mm	CODICE	EAN		
4,5	40	E14	2700	470	330°	90x20	WLD7204X2	8031453020385	10/50	
4,5	40	E14	4000	470	330°	90x20	WLD7204X3	8031453025328	10/50	



TUBOLARE T25 LED STICK 220-240V

BTL CATEGORIA SCONTO 21



W	W=	BASE	K	lm		H x W mm	CODICE	EAN		
4,5	40	E14	2700	470	330°	90x25	WLD7604X2	8031453017729	10/50	
4,5	40	E14	4000	470	330°	90x25	WLD7604X3	8031453025335	10/50	
6,5	60	E14	2700	806	330°	90x25	WLD7606X2	8031453027339	10/50	
6,5	60	E14	4000	806	330°	90x25	WLD7606X3	8031453027346	10/50	



TUBOLARE T32 LED STICK 220-240V

BTL CATEGORIA SCONTO 21



W	W=	BASE	K	lm		H x W mm	CODICE	EAN		
8,5	75	E27	3000	1055	330°	106x32	WLD7708X2BB	8031453028879	10/50	
8,5	75	E27	4000	1055	330°	106x32	WLD7708X3	8031453028886	10/50	

SHOT
BOT LIGHTING

LAMPADE LED STICK SATINATE
FROSTED LED STICK BULBS





GOCCIA LED STICK SATINATA 220-240V

BTL CATEGORIA SCONTO 21

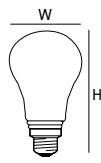

IP 20

20.000h

20.000



W	W=	BASE	K	lm		H x W mm	CODICE	EAN		
7,0	60	E27	2700	806	330°	108x60	WLD1008X2S	8031453014629	10/50	
7,0	60	E27	4000	806	330°	108x60	WLD1008X3S	8031453024079	10/50	
8,5	75	E27	2700	1055	330°	108x60	WLD1010X2S	8031453024086	10/50	
8,5	75	E27	4000	1055	330°	108x60	WLD1010X3S	8031453024093	10/50	



SFERA LED STICK SATINATA 220-240V

BTL CATEGORIA SCONTO 21

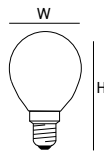

IP 20

20.000h

20.000



W	W=	BASE	K	lm		H x W mm	CODICE	EAN		
2,5	25	E14	2700	250	330°	80x45	WLD3002X2S	8031453009076	10/50	
4,5	40	E14	2700	470	330°	80x45	WLD3004X2S	8031453009106	10/50	
4,5	40	E14	4000	470	330°	80x45	WLD3004X3S	8031453019365	10/50	
4,5	40	E27	2700	470	330°	78x45	WLD3104X2S	8031453011949	10/50	

OLIVA LED STICK SATINATA 220-240V

BTL CATEGORIA SCONTO 21

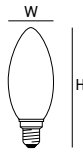

W	W=	BASE	K	lm		H x W mm	CODICE	EAN		
2.5	25	E14	2700	250	330°	97x35	WLD2002X2S	8031453009014	10/50	
4.5	40	E14	2700	470	330°	97x35	WLD2004X2S	8031453009045	10/50	
4.5	40	E14	4000	470	330°	97x35	WLD2004X3S	8031453019334	10/50	
6.5	60	E14	2700	806	330°	97x35	WLD2006X2S	8031453024109	10/50	
6.5	60	E14	4000	806	330°	97x35	WLD2006X3S	8031453024116	10/50	

TORTIGLIONE LED STICK SATINATA 220-240V

BTL CATEGORIA SCONTO 21



W	W=	BASE	K	lm		H x W mm	CODICE	EAN		
2.5	25	E14	2700	250	330°	97x35	WLD2002T2S	8031453025212	10/50	
4.5	40	E14	2700	470	330°	97x35	WLD2004T2S	8031453011338	10/50	
4.5	40	E14	4000	470	330°	97x35	WLD2004T3S	8031453019358	10/50	
6.5	60	E14	2700	806	330°	97x35	WLD2006T2S	8031453024123	10/50	
6.5	60	E14	4000	806	330°	97x35	WLD2006T3S	8031453024147	10/50	

FIAMMA LED STICK SATINATA 220-240V

BTL CATEGORIA SCONTO 21

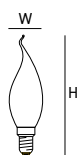

W	W=	BASE	K	lm		H x W mm	CODICE	EAN		
4,5	40	E14	2700	470	330°	123x35	WLD2004F2S	8031453011307	10/50	
4,5	40	E14	4000	470	330°	123x35	WLD2004F3S	8031453019341	10/50	
6,5	60	E14	2700	806	330°	123x35	WLD2006F2S	8031453024130	10/50	
6,5	60	E14	4000	806	330°	123x35	WLD2006F3S	8031453024154	10/50	

GLOBO 125 LED STICK SATINATA 220-240V

BTL CATEGORIA SCONTO 21

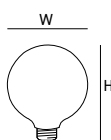

W	W=	BASE	K	lm		H x W mm	CODICE	EAN		
8,5	75	E27	2700	1055	330°	178x125	WLD4010X2S	8031453012236	5/20	

REFLECTOR R39 LED STICK SATINATA 220-240V

BTL CATEGORIA SCONTO 21

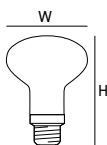

W	W=	BASE	K	lm		H x W mm	CODICE	EAN		
2,5	14	E14	2700	125	110°	67x39	WLD500252	8031453019815	10/50	



REFLECTOR R50 LED STICK SATINATA 220-240V

BTL CATEGORIA SCONTO 21

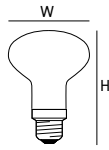

W	W=	BASE	K	lm		H x W mm	CODICE	EAN		
4,0	30	E14	2700	330	120°	85x50	WLD500452	8031453019822	10/50	



REFLECTOR R63 LED STICK SATINATA 220-240V

BTL CATEGORIA SCONTO 21

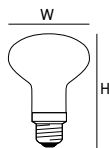

W	W=	BASE	K	lm		H x W mm	CODICE	EAN		
7,0	60	E27	2700	806	110°	102x63	WLD500752	8031453024383	10/50	



REFLECTOR R80 LED STICK SATINATA 220-240V

BTL CATEGORIA SCONTO 21

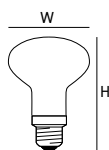

W	W=	BASE	K	lm		H x W mm	CODICE	EAN		
4,5	40	E27	2700	470	80°	116x80	WLD500652	8031453014353	10/50	
7,0	60	E27	2700	806	80°	114x80	WLD500852	8031453024390	10/50	



REFLECTOR R125 LED STICK SATINATA DIMMERABILE 220-240V

BTL CATEGORIA SCONTO 21

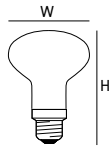

W	W=	BASE	K	lm		H x W mm	CODICE	EAN		
11,0	75	E27	2700	1055	120°	180x125	WLD501152D	8031453022532	5/20	



GOCCIA LED STICK CUPOLA ARGENTATA 220-240V

BTL CATEGORIA SCONTO 21

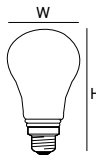

W	W=	BASE	K	lm		H x W mm	CODICE	EAN		
7,0	53	E27	2700	680	280°	108x60	WLD1008X2CA	8031453014018	10/50	



SFERA LED STICK CUPOLA ARGENTATA 220-240V

BTL CATEGORIA SCONTO 21

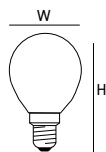

W	W=	BASE	K	lm		H x W mm	CODICE	EAN		
4,5	35	E14	2700	400	270°	80x45	WLD3005X2CA	8031453014049	10/50	



GOCCIA LED STICK CON SENSORE CREPUSCOLARE 220-240V

BTL CATEGORIA SCONTO 21

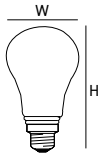

_ Sensore crepuscolare integrato nella virola _ Dusk sensor integrated in the body

IP 20

20.000h

20.000



AUTOMATIC ON-OFF

W	W=	BASE	K	lm	lm		H x W mm	CODICE	EAN		
7,8	75	E27	2700	1055	1055	330°	108x60	WLDSENS10X2	8031453026110	10/50	D

SHOT
BOT LIGHTING

LAMPADE FULL LIGHT
FULL LIGHT BULBS



GOCCIA FULL LIGHT 220-240V

BTL CATEGORIA SCONTO 21

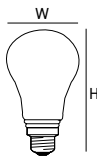

W	W=	BASE	K	lm		H x W mm	CODICE	EAN		
7,0	60	E27	2700	806	330°	108x60	MLD1008X2	8031453018900	10/50	
7,0	60	E27	4000	806	330°	108x60	MLD1008X3	8031453021610	10/50	
8,5	75	E27	2700	1055	330°	108x60	MLD1010X2	8031453018917	10/50	
8,5	75	E27	4000	1055	330°	108x60	MLD1010X3	8031453021627	10/50	
10,5	100	E27	2700	1521	330°	108x60	MLD1011X2	8031453018924	10/50	
10,5	100	E27	4000	1521	330°	108x60	MLD1011X3	8031453021634	10/50	
18,0	150	E27	2700	2452	330°	126x70	MLD1016X2	8031453021412	10/50	
18,0	150	E27	4000	2452	330°	126x70	MLD1016X3	8031453021641	10/50	
22,0	200	E27	2700	3452	330°	162x95	MLD1022X2	8031453028510	5/20	
22,0	200	E27	4000	3452	330°	162x95	MLD1022X3	8031453028527	5/20	



SFERA FULL LIGHT 220-240V

BTL CATEGORIA SCONTO 21

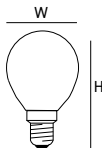

W	W=	BASE	K	lm		H x W mm	CODICE	EAN		
4,5	40	E14	2700	470	330°	80x45	MLD3004X2	8031453018948	10/50	
4,5	40	E14	4000	470	330°	80x45	MLD3004X3	8031453021696	10/50	
6,5	60	E14	2700	806	330°	80x45	MLD3006X2	8031453021276	10/50	
6,5	60	E14	4000	806	330°	80x45	MLD3006X3	8031453021702	10/50	
7,0	75	E14	2700	1055	330°	80x45	MLD3007X2	8031453028190	10/50	
7,0	75	E14	4000	1055	330°	80x45	MLD3007X3	8031453028206	10/50	
4,5	40	E27	2700	470	330°	78x45	MLD3104X2	8031453018955	10/50	
4,5	40	E27	4000	470	330°	78x45	MLD3104X3	8031453021672	10/50	
6,5	60	E27	2700	806	330°	78x45	MLD3106X2	8031453021283	10/50	
6,5	60	E27	4000	806	330°	78x45	MLD3106X3	8031453021689	10/50	
7,0	75	E27	2700	1055	330°	78x45	MLD3107X2	8031453028213	10/50	
7,0	75	E27	4000	1055	330°	78x45	MLD3107X3	8031453028220	10/50	

OLIVA FULL LIGHT 220-240V

BTL CATEGORIA SCONTO 21



IP 20

20.000h

20.000



W	W=	BASE	K	lm		H x W mm	CODICE	EAN		
4,5	40	E14	2700	470	330°	97x35	MLD2004X2	8031453018931	10/50	
4,5	40	E14	4000	470	330°	97x35	MLD2004X3	8031453021658	10/50	
6,5	60	E14	2700	806	330°	97x35	MLD2006X2	8031453021269	10/50	
6,5	60	E14	4000	806	330°	97x35	MLD2006X3	8031453021665	10/50	
7,0	75	E14	2700	1055	330°	97x35	MLD2007X2	8031453028176	10/50	
7,0	75	E14	4000	1055	330°	97x35	MLD2007X3	8031453028183	10/50	

TORTIGLIONE FULL LIGHT 220-240V

BTL CATEGORIA SCONTO 21



IP 20

20.000h

20.000



W	W=	BASE	K	lm		H x W mm	CODICE	EAN		
4,5	40	E14	2700	470	330°	97x35	MLD2004T2	8031453023119	10/50	
6,5	60	E14	2700	806	330°	97x35	MLD2006T2	8031453023126	10/50	

FIAMMA FULL LIGHT 220-240V

BTL CATEGORIA SCONTO 21

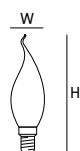

IP 20

20.000h

20.000



W	W=	BASE	K	lm		H x W mm	CODICE	EAN		
4,5	40	E14	2700	470	330°	123x35	MLD2004F2	8031453023096	10/50	
6,5	60	E14	2700	806	330°	123x35	MLD2006F2	8031453023102	10/50	



GLOBO 95 FULL LIGHT 220-240V **AGGIORNATO**

BTL CATEGORIA SCONTO 21

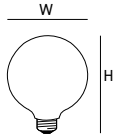

IP 20

h
20.000

20.000



W	W=	BASE	K	lm		H x W mm	CODICE	EAN		
7,0	60	E27	2700	806	330°	140x95	MLD4208X2	8031453018979	5/20	
NEW	10,5	E27	2700	1521	330°	140x95	MLD4215X2	8031453033446	5/20	



GLOBO 125 FULL LIGHT 220-240V

BTL CATEGORIA SCONTO 21

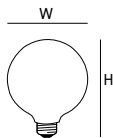

IP 20

h
20.000

20.000



W	W=	BASE	K	lm		H x W mm	CODICE	EAN		
7,0	60	E27	2700	806	330°	178x125	MLD4008X2	8031453018962	5/20	
8,5	75	E27	2700	1055	330°	178x125	MLD4010X2	8031453019495	5/20	
11,0	100	E27	2700	1521	330°	178x125	MLD4011X2	8031453019785	5/20	
11,0	100	E27	4000	1521	330°	178x125	MLD4011X3	8031453021719	5/20	
18,0	150	E27	2700	2452	330°	178x125	MLD4016X2	8031453024246	5/20	
18,0	150	E27	4000	2452	330°	178x125	MLD4016X3	8031453024253	5/20	
21,5	200	E27	2700	3452	330°	178x125	MLD4022X2	8031453026394	5/20	



GOCCIA FULL LIGHT DIMMERABILE 220-240V

BTL CATEGORIA SCONTO 21

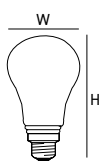

IP 20

20.000h

20.000



W	W=	BASE	K	lm		H x W mm	CODICE	EAN		
7,0	60	E27	2700	806	330°	108x60	MLD1008X2D	8031453020941	10/50	
11,0	100	E27	2700	1521	330°	108x60	MLD1011X2D	8031453023966	10/50	



SFERA FULL LIGHT DIMMERABILE 220-240V

BTL CATEGORIA SCONTO 21

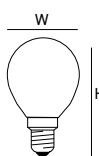

IP 20

20.000h

20.000



W	W=	BASE	K	lm		H x W mm	CODICE	EAN		
4,5	40	E14	2700	470	330°	80x45	MLD3004X2D	8031453023973	10/50	
5,9	60	E14	2700	806	330°	80x45	MLD3006X2D	8031453027292	10/50	



OLIVA FULL LIGHT DIMMERABILE 220-240V

BTL CATEGORIA SCONTO 21

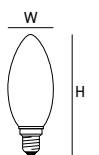

IP 20

20.000h

20.000



W	W=	BASE	K	lm		H x W mm	CODICE	EAN		
4,5	40	E14	2700	470	330°	97x35	MLD2004X2D	8031453021214	10/50	
5,9	60	E14	2700	806	330°	97x35	MLD2006X2D	8031453027285	10/50	



GLOBO 125 FULL LIGHT DIMMERABILE 220-240V

BTL CATEGORIA SCONTO 21

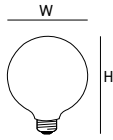

IP 20

20.000h

20.000



W	W=	BASE	K	lm		H x W mm	CODICE	EAN		
11,0	100	E27	2700	1521	330°	178x125	MLD4013X2D	8031453020972	5/20	



TUBOLARE T38 FULL LIGHT DIMMERABILE 220-240V

NEW

BTL CATEGORIA SCONTO 21



IP 20

20.000h

20.000



W	W=	BASE	K	lm		H x W mm	CODICE	EAN		
14,0	120	E27	2700	1900	330°	150x38	MLD7814X2D	8031453032722	10/50	

SHOT
BOT LIGHTING

LAMPADE VINTAGE
VINTAGE BULBS





EDISON LED STICK GOLD 220-240V

BTL CATEGORIA SCONTO 21

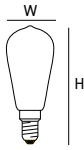

IP 20

20.000h

20.000



W	W=	BASE	K	lm		H x W mm	CODICE	EAN		
7,0	55	E27	2500	725	330°	133x58	WLD7508X2G	8031453020453	10/50	



GOCCIA LED STICK GOLD 220-240V

BTL CATEGORIA SCONTO 21

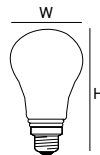

IP 20

20.000h

20.000



W	W=	BASE	K	lm		H x W mm	CODICE	EAN		
7,0	55	E27	2500	725	330°	108x60	WLD1008X2G	8031453020408	10/50	



OLIVA LED STICK GOLD 220-240V

BTL CATEGORIA SCONTO 21



IP 20

20.000h

20.000



W	W=	BASE	K	lm		H x W mm	CODICE	EAN		
4,5	37	E14	2500	420	330°	97x35	WLD2004X2G	8031453020422	10/50	

TORTIGLIONE LED STICK GOLD 220-240V

BTL CATEGORIA SCONTO 21



W	W=	BASE	K	lm		H x W mm	CODICE	EAN		
4,5	37	E14	2500	420	330°	97x35	WLD2004T2G	8031453020415	10/50	

GLOBO 95 LED STICK GOLD 220-240V

BTL CATEGORIA SCONTO 21

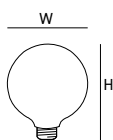

W	W=	BASE	K	lm		H x W mm	CODICE	EAN		
7,0	55	E27	2500	725	330°	140x95	WLD4208X2G	8031453020439	5/20	

GLOBO 125 LED STICK GOLD 220-240V

BTL CATEGORIA SCONTO 21

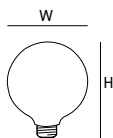

W	W=	BASE	K	lm		H x W mm	CODICE	EAN		
7,0	55	E27	2500	725	330°	178x125	WLD4008X2G	8031453020446	5/20	



GOCCIA F.O.B. STICK DIMMERABLE 220-240V

BTL CATEGORIA SCONTO 21



IP 20 25.000h 20.000

W	W=	BASE	K	lm		H x W mm	CODICE	EAN		
8,0	-	E27	2000	500	330°	298x160	WLD6108X2AM	8031453021016	1/6	-



GLOBO F.O.B. STICK DIMMERABLE 220-240V

BTL CATEGORIA SCONTO 21

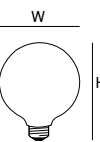

IP 20 25.000h 20.000

W	W=	BASE	K	lm		H x W mm	CODICE	EAN		
8,0	-	E27	2000	500	330°	300x200	WLD6008X2AM	8031453021009	1/4	-



BT F.O.B. STICK DIMMERABLE 220-240V

BTL CATEGORIA SCONTO 21

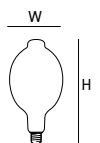

IP 20 25.000h 20.000

W	W=	BASE	K	lm		H x W mm	CODICE	EAN		
8,0	-	E27	2000	500	330°	380x180	WLD6208X2AM	8031453021023	1/6	-



ALVEARE F.O.B. STICK DIMMERABILE 220-240V

BTL CATEGORIA SCONTO 21



IP 20 25.000h 20.000

W	W=	BASE	K	lm		H x W mm	CODICE	EAN		
8,0	-	E27	2000	500	330°	390x200	WLD6308X2AM	8031453021351	1/4	-



UFO F.O.B. STICK DIMMERABILE 220-240V

BTL CATEGORIA SCONTO 21



IP 20 25.000h 20.000

W	W=	BASE	K	lm		H x W mm	CODICE	EAN		
8,0	-	E27	2000	500	330°	265x220	WLD6408X2AM	8031453021368	1/4	-



LANTERNA F.O.B. STICK DIMMERABILE 220-240V

BTL CATEGORIA SCONTO 21



IP 20 25.000h 20.000

W	W=	BASE	K	lm		H x W mm	CODICE	EAN		
8,0	-	E27	2000	500	330°	250x140	WLD6508X2AM	8031453021375	1/6	-
8,0	-	E27	2000	250	330°	250x140	WLD6508X2SK	8031453021382	1/6	-

SHOT
BOT LIGHTING

LAMPADE SMD
SMD LIGHT BULBS





GOCCIA OPALE A60 220-240V

BTL CATEGORIA SCONTO 21

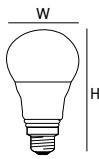

IP 20

15.000

40.000



W	W=	BASE	K	lm		H x W mm	CODICE	EAN		
4,9	40	E27	2700	470	200°	106x60	ELD1007X2	8031453008505	10/100	
4,9	40	E27	6500	470	200°	106x60	ELD1007X1	8031453008475	10/100	
8,5	60	E27	2700	806	200°	106x60	ELD1009X2	8031453009823	10/100	
8,5	60	E27	3000	806	200°	106x60	ELD1009X2BB	8031453020064	10/100	
8,5	60	E27	4000	806	200°	106x60	ELD1009X3	8031453017057	10/100	
8,5	60	E27	6500	806	200°	106x60	ELD1009X1	8031453009793	10/100	
11,0	75	E27	2700	1060	200°	118x60	ELD1012X2	8031453009885	10/100	
11,0	75	E27	3000	1060	200°	118x60	ELD1012X2BB	8031453020071	10/100	
11,0	75	E27	4000	1060	200°	118x60	ELD1012X3	8031453017088	10/100	
11,0	75	E27	6500	1060	200°	118x60	ELD1012X1	8031453009854	10/100	
14,0	100	E27	2700	1521	200°	123x60	ELD1015X2	8031453014995	10/100	
14,0	100	E27	3000	1521	200°	123x60	ELD1015X2BB	8031453020088	10/100	
14,0	100	E27	4000	1521	200°	123x60	ELD1015X3	8031453017118	10/100	
14,0	100	E27	6500	1521	200°	123x60	ELD1015X1	8031453014964	10/100	
14,0	120	E27	2700	1901	180°	120x60	ELD1016X2B	8031453028435	10/50	
14,0	120	E27	3000	1901	180°	120x60	ELD1016X2BB	8031453028442	10/50	
14,0	120	E27	4000	1901	180°	120x60	ELD1016X3B	8031453028459	10/50	
14,0	120	E27	6500	1901	180°	120x60	ELD1016X1B	8031453028428	10/50	

GOCCIA OPALE A67 220-240V

BTL CATEGORIA SCONTO 21

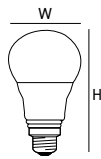

IP 20

15.000h

40.000



W	W=	BASE	K	lm		H x W mm	CODICE	EAN		
17,5	150	E27	2700	2452	200°	143x67	ELD1020X2	8031453018184	10/50	
17,5	150	E27	4000	2452	200°	143x67	ELD1020X3	8031453018436	10/50	
17,5	150	E27	6500	2452	200°	143x67	ELD1020X1	8031453018153	10/50	

GOCCIA OPALE A80 220-240V

BTL CATEGORIA SCONTO 21

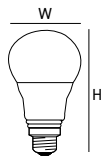

IP 20

15.000h

40.000



W	W=	BASE	K	lm		H x W mm	CODICE	EAN		
23,5	190	E27	2700	3400	200°	155x80	ELD1025X2	8031453023195	20	
23,5	190	E27	4000	3400	200°	155x80	ELD1025X3	8031453023201	20	
23,5	190	E27	6500	3400	200°	155x80	ELD1025X1	8031453023188	20	

SFERA OPALE E27 220-240V **AGGIORNATO**

BTL CATEGORIA SCONTO 21

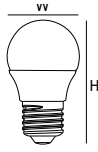

W	W=	BASE	K	lm		H x W mm	CODICE	EAN			
2,7	25	E27	2700	250	200°	74x45	ELD3103X2	8031453018764	10/100		
2,7	25	E27	4000	250	200°	74x45	ELD3103X3	8031453018771	10/100		
3,0	25	E27	6500	250	200°	74x45	ELD3103X1	8031453018757	10/100		
4,9	40	E27	2700	470	240°	74x45	ELD3106X2	8031453010485	10/100		
4,9	40	E27	3000	470	240°	74x45	ELD3106X2BB	8031453020118	10/100		
4,9	40	E27	4000	470	240°	74x45	ELD3106X3	8031453017200	10/100		
4,9	40	E27	6500	470	240°	74x45	ELD3106X1	8031453010454	10/100		
7,2	60	E27	2700	806	220°	84x45	ELD3110X2	8031453019136	10/100		
7,2	60	E27	3000	806	220°	84x45	ELD3110X2BB	8031453020125	10/100		
7,2	60	E27	4000	806	220°	84x45	ELD3110X3	8031453019143	10/100		
7,2	60	E27	6500	806	220°	84x45	ELD3110X1	8031453019129	10/100		
NEW	6,5	75	E27	2700	1055	150°	77x45	ELD3111X2	8031453033217	10/100	
NEW	6,5	75	E27	3000	1055	150°	77x45	ELD3111X2BB	8031453033224	10/100	
NEW	6,5	75	E27	4000	1055	150°	77x45	ELD3111X3	8031453033231	10/100	
NEW	6,5	75	E27	6500	1055	150°	77x45	ELD3111X1	8031453033200	10/100	



SFERA OPALE E14 220-240V

AGGIORNATO

BTL CATEGORIA SCONTO 21

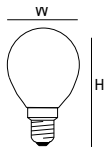

IP 20

15.000h

40.000



W	W=	BASE	K	lm		H x W mm	CODICE	EAN				
2,7	25	E14	2700	250	200°	78x45	ELD3003X2	8031453010065	10/100			
2,7	25	E14	4000	250	200°	78x45	ELD3003X3	8031453017149	10/100			
2,7	25	E14	6500	250	200°	78x45	ELD3003X1	8031453010034	10/100			
4,9	40	E14	2700	470	240°	78x45	ELD3006X2	8031453010126	10/100			
4,9	40	E14	3000	470	240°	78x45	ELD3006X2BB	8031453020095	10/100			
4,9	40	E14	4000	470	240°	78x45	ELD3006X3	8031453017170	10/100			
4,9	40	E14	6500	470	240°	78x45	ELD3006X1	8031453010096	10/100			
7,2	60	E14	2700	806	220°	85x45	ELD3010X2	8031453019105	10/100			
7,2	60	E14	3000	806	220°	85x45	ELD3010X2BB	8031453020101	10/100			
7,2	60	E14	4000	806	220°	85x45	ELD3010X3	8031453019112	10/100			
7,2	60	E14	6500	806	220°	85x45	ELD3010X1	8031453019099	10/100			
6,5	75	E14	2700	1055	150°	82x45	ELD3011X2	8031453033170	10/100			NEW
6,5	75	E14	3000	1055	150°	82x45	ELD3011X2BB	8031453033187	10/100			NEW
6,5	75	E14	4000	1055	150°	82x45	ELD3011X3	8031453033194	10/100			NEW
6,5	75	E14	6500	1055	150°	82x45	ELD3011X1	8031453033163	10/100			NEW

OLIVA OPALE 220-240V **AGGIORNATO**

BTL CATEGORIA SCONTO 21

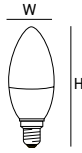

IP 20

15.000h

50.000



W	W=	BASE	K	lm		H x W mm	CODICE	EAN			
2,7	25	E14	2700	250	280°	102x35	ELD2003X2	8031453009946	10/100		
2,7	25	E14	4000	250	280°	102x35	ELD2003X3	8031453017231	10/100		
2,7	25	E14	6500	250	280°	102x35	ELD2003X1	8031453009915	10/100		
4,9	40	E14	2700	470	280°	102x35	ELD2006X2	8031453010003	10/100		
4,9	40	E14	3000	470	280°	102x35	ELD2006X2BB	8031453020132	10/100		
4,9	40	E14	4000	470	280°	102x35	ELD2006X3	8031453017262	10/100		
4,9	40	E14	6500	470	280°	102x35	ELD2006X1	8031453009977	10/100		
7,2	60	E14	2700	806	280°	110x38	ELD2010X2	8031453019075	10/100		
7,2	60	E14	3000	806	280°	110x38	ELD2010X2BB	8031453026417	10/100		
7,2	60	E14	4000	806	280°	110x38	ELD2010X3	8031453019082	10/100		
7,2	60	E14	6500	806	280°	110x38	ELD2010X1	8031453019068	10/100		
NEW	6,5	75	E14	2700	1055	240°	102x35	ELD2011X2	8031453033132	10/100	
NEW	6,5	75	E14	3000	1055	240°	102x35	ELD2011X2BB	8031453033149	10/100	
NEW	6,5	75	E14	4000	1055	240°	102x35	ELD2011X3	8031453033156	10/100	
NEW	6,5	75	E14	6500	1055	240°	102x35	ELD2011X1	8031453033125	10/100	



GLOBO 95 OPALE 220-240V

BTL CATEGORIA SCONTO 21

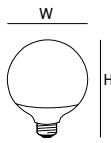

W	W=	BASE	K	lm		H x W mm	CODICE	EAN		
9,5	75	E27	2700	1055	180°	133x95	SLD4112X2B	8031453013738	6	
9,5	75	E27	4000	1055	180°	133x95	SLD4112X3B	8031453018887	6	
9,5	75	E27	6500	1055	180°	133x95	SLD4112X1B	8031453013714	6	



GLOBO 120 OPALE 220-240V

BTL CATEGORIA SCONTO 21

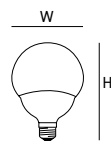

W	W=	BASE	K	lm		H x W mm	CODICE	EAN		
13,5	100	E27	2700	1521	200°	172x120	SLD4115X2B	8031453013776	6	
13,5	100	E27	4000	1521	200°	172x120	SLD4115X3B	8031453018894	6	
13,5	100	E27	6500	1521	200°	172x120	SLD4115X1B	8031453013752	6	
16,0	120	E27	2700	1900	200°	172x120	SLD4121X2B	8031453013813	6	
16,0	120	E27	3000	1900	200°	172x120	SLD4121X2BB	8031453022594	6	
16,0	120	E27	4000	1900	200°	172x120	SLD4121X3B	8031453018863	6	
16,0	120	E27	6500	1900	200°	172x120	SLD4121X1B	8031453013790	6	
20,0	150	E27	2700	2452	180°	172x120	SLD4122X2B	8031453015190	6	
20,0	150	E27	3000	2452	180°	172x120	SLD4122X2BB	8031453022600	6	
20,0	150	E27	4000	2452	180°	172x120	SLD4122X3B	8031453018870	6	
20,0	150	E27	6500	2452	180°	172x120	SLD4122X1B	8031453015176	6	

GOCCIA OPALE DIMMERABILE 220-240V

BTL CATEGORIA SCONTO 21

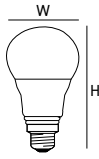

IP 20

25.000h

40.000



W	W=	BASE	K	lm		H x W mm	CODICE	EAN		
8,4	60	E27	2700	806	240°	110x60	SLD1009X2D	8031453014254	10/50	
13,6	100	E27	2700	1521	220°	120x60	SLD1014X2D	8031453012113	10/50	
13,6	100	E27	4000	1521	220°	120x60	SLD1014X3D	8031453023904	10/50	
18,0	150	E27	2700	2452	200°	143x67	SLD1021X2D	8031453023911	10/50	
21,0	150	E27	4000	2452	200°	143x67	SLD1021X3D	8031453023928	10/50	

SFERA OPALE DIMMERABILE 220-240V

BTL CATEGORIA SCONTO 21

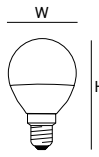

IP 20

25.000h

40.000



W	W=	BASE	K	lm		H x W mm	CODICE	EAN		
4,5	40	E14	2700	470	240°	78x45	SLD3006X2D	8031453012175	10/100	

OLIVA OPALE DIMMERABILE 220-240V

BTL CATEGORIA SCONTO 21

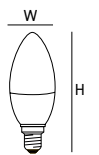

IP 20

25.000h

40.000



W	W=	BASE	K	lm		H x W mm	CODICE	EAN		
4,9	40	E14	2700	470	280°	102x35	SLD2006X2D	8031453012144	10/50	



PICCOLA PERA PER FRIGORIFERI 220-240V

BTL CATEGORIA SCONTO 21

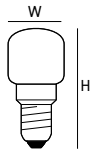

W	W=	BASE	K	lm		H x W mm	CODICE	EAN		
1,3	16	E14	6500	150	120°	55x25	SLD7102X1FRB	8031453018986	20/200	



PICCOLA PERA 220-240V

BTL CATEGORIA SCONTO 21

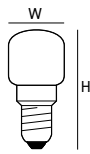

W	W=	BASE	K	lm		H x W mm	CODICE	EAN		
1,3	16	E14	3000	150	120°	55x25	SLD7102X2B	8031453018993	20/200	



PICCOLA PERA COLORATA 220-240V

BTL CATEGORIA SCONTO 21

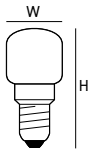

IP 20

20.000h

20.000



W	W=	BASE	COLOR	lm		H x W mm	CODICE	EAN		
1,5	-	E14	BLUE	25	120°	55x25	SLD7202XB	8031453019006	20/200	-
1,5	-	E14	GREEN	200	120°	55x25	SLD7202XG	8031453019013	20/200	-
1,5	-	E14	RED	20	120°	55x25	SLD7202XR	8031453019020	20/200	-



PICCOLA PERA 24V DC

BTL CATEGORIA SCONTO 21

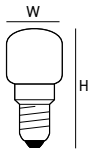

IP 20

15.000h

30.000



per cancelli / for gates

W	W=	BASE	K	lm		H x W mm	CODICE	EAN		
1,6	-	E14	2700	200	120°	56x25	SLD7102X2DC	8031453025069	20/200	



TUBOLARE T37 220-240V

BTL CATEGORIA SCONTO 21



IP 20

20.000h

20.000



W	W=	BASE	K	lm		H x W mm	CODICE	EAN		
7,0	60	E14	2700	806	270°	126x38	SLD7308X2	8031453017941	10/50	
7,0	60	E14	4000	806	270°	126x38	SLD7308X3	8031453021559	10/50	
7,0	60	E14	6500	806	270°	126x38	SLD7308X1	8031453017910	10/50	
8,0	75	E14	2700	1055	270°	126x38	SLD7309X2	8031453024178	10/50	
8,0	75	E14	4000	1055	270°	126x38	SLD7309X3	8031453024185	10/50	
8,0	75	E14	6500	1055	270°	126x38	SLD7309X1	8031453024161	10/50	
7,0	60	E27	2700	806	270°	126x38	SLD7408X2	8031453018009	10/50	
7,0	60	E27	4000	806	270°	126x38	SLD7408X3	8031453021566	10/50	
7,0	60	E27	6500	806	270°	126x38	SLD7408X1	8031453017972	10/50	



TUBOLARE T45 220-240V

BTL CATEGORIA SCONTO 21



IP 20

20.000h

20.000



W	W=	BASE	K	lm		H x W mm	CODICE	EAN		
9,5	75	E27	2700	1055	270°	152x45	SLD7410X2	8031453018061	10/50	
9,5	75	E27	4000	1055	270°	152x45	SLD7410X3	8031453021573	10/50	
9,5	75	E27	6500	1055	270°	152x45	SLD7410X1	8031453018030	10/50	
12,0	100	E27	2700	1521	270°	152x45	SLD7414X2	8031453021597	10/50	
12,0	100	E27	4000	1521	270°	152x45	SLD7414X3	8031453021603	10/50	
12,0	100	E27	6500	1521	270°	152x45	SLD7414X1	8031453021580	10/50	



REFLECTOR R39 220-240V

BTL CATEGORIA SCONTO 21



W	W=	BASE	K	lm		H x W mm	CODICE	EAN		
2,5	25	E14	2700	250	120°	67x39	SLD500352B	8031453018702	10/50	
3,0	25	E14	4000	250	120°	67x39	SLD500353B	8031453018726	10/50	
3,0	25	E14	6500	250	120°	67x39	SLD500351B	8031453018689	10/50	



REFLECTOR R50 220-240V

BTL CATEGORIA SCONTO 21



W	W=	BASE	K	lm		H x W mm	CODICE	EAN		
4,9	40	E14	2700	470	120°	83x50	SLD500552B	8031453018788	10/50	
4,9	40	E14	3000	470	120°	83x50	SLD500552BB	8031453020033	10/50	
4,9	40	E14	4000	470	120°	83x50	SLD500553B	8031453018795	10/50	
4,9	40	E14	6500	470	120°	83x50	SLD500551B	8031453018740	10/50	



REFLECTOR R63 220-240V

BTL CATEGORIA SCONTO 21



W	W=	BASE	K	lm		H x W mm	CODICE	EAN		
8,0	60	E27	2700	806	120°	97x63	SLD500952B	8031453018818	10/50	
8,0	60	E27	3000	806	120°	97x63	SLD500952BB	8031453020040	10/50	
8,0	60	E27	4000	806	120°	97x63	SLD500953B	8031453018825	10/50	
8,0	60	E27	6500	806	120°	97x63	SLD500951B	8031453018801	10/50	



REFLECTOR R80 220-240V **AGGIORNATO**

BTL CATEGORIA SCONTO 21



W	W=	BASE	K	lm		H x W mm	CODICE	EAN		
9,5	75	E27	2700	1055	120°	114x81	SLD501252B	8031453018849	10/50	
9,5	75	E27	4000	1055	120°	114x81	SLD501253B	8031453018856	10/50	
9,5	75	E27	6500	1055	120°	114x81	SLD501251B	8031453018832	10/50	



LED GU10 H - 36° 220-240V

BTL CATEGORIA SCONTO 21

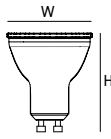

W	W=	BASE	K	lm	lm	cd		H x W mm	CODICE	EAN		
2,2	50	GU10	3000	360	350	650	36°	54x50	SLH630232	8031453029135	10/100	B
2,0	50	GU10	4000	380	360	600	36°	54x50	SLH630233	8031453029142	10/100	A
2,0	50	GU10	6500	380	360	600	36°	54x50	SLH630231	8031453029128	10/100	A



LED GU10 HP - 36° 220-240V

NEW

BTL CATEGORIA SCONTO 21

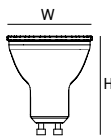

W	W=	BASE	K	lm	lm	cd		H x W mm	CODICE	EAN		
7,0	135	GU10	2700	1100	1000	1800	36°	56x50	SLD631032B	8031453032784	10/100	C
7,0	135	GU10	3000	1100	1000	1800	36°	56x50	SLD631032BB	8031453032791	10/100	C
7,0	135	GU10	4000	1100	1000	1800	36°	56x50	SLD631033B	8031453032807	10/100	C
7,0	135	GU10	6500	1100	1000	1800	36°	56x50	SLD631031B	8031453032777	10/100	C



LED GU10 - 36° 220-240V

BTL CATEGORIA SCONTO 21

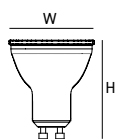

W	W=	BASE	K	lm	lm	cd		H x W mm	CODICE	EAN			
4,2	50	GU10		2700	370	345	640	36°	54x50	SLD630532B	8031453018498	10/100	
4,2	50	GU10		4000	370	345	640	36°	54x50	SLD630533B	8031453018504	10/100	
4,2	50	GU10		6500	370	345	640	36°	54x50	SLD630531B	8031453018481	10/100	
4,9	75	GU10		2700	595	535	950	36°	54x50	SLD630732B	8031453018559	10/100	
4,9	75	GU10		3000	595	540	1000	36°	54x50	SLD630732BB	8031453019662	10/100	
4,9	75	GU10		4000	595	535	950	36°	54x50	SLD630733B	8031453018566	10/100	
4,9	75	GU10		6500	595	535	950	36°	54x50	SLD630731B	8031453018542	10/100	



LED GU10 - 60° 220-240V

BTL CATEGORIA SCONTO 21

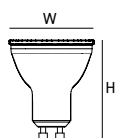

W	W=	BASE	K	lm	lm	cd		H x W mm	CODICE	EAN			
4,2	44	GU10		2700	360	345	440	60°	54x50	SLD630542B	8031453018528	10/100	
4,2	44	GU10		4000	360	345	450	60°	54x50	SLD630543B	8031453018535	10/100	
4,2	44	GU10		6500	360	345	480	60°	54x50	SLD630541B	8031453018511	10/100	
4,9	70	GU10		2700	570	500	600	60°	54x50	SLD630742B	8031453018580	10/100	
4,9	70	GU10		3000	570	500	600	60°	54x50	SLD630742BB	8031453019679	10/100	
4,9	70	GU10		4000	570	500	600	60°	54x50	SLD630743B	8031453018597	10/100	
4,9	70	GU10		6500	570	500	600	60°	54x50	SLD630741B	8031453018573	10/100	



LED GU10 H - 100° 220-240V

BTL CATEGORIA SCONTO 21

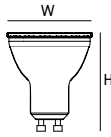

W	W=	BASE	K	lm	lm	cd		H x W mm	CODICE	EAN			
4,7	90	GU10		3000	890	850	420	100°	56x50	SLH630552	8031453031831	10/100	
4,7	90	GU10		4000	890	850	420	100°	56x50	SLH630553	8031453031848	10/100	
4,7	90	GU10		6500	890	850	420	100°	56x50	SLH630551	8031453031824	10/100	



LED GU10 HP - 100° 220-240V

NEW

BTL CATEGORIA SCONTO 21

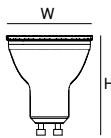

W	W=	BASE	K	lm	lm	cd		H x W mm	CODICE	EAN			
7,0	110	GU10		2700	1100	1000	750	100°	56x50	SLD631052B	8031453032821	10/100	
7,0	110	GU10		3000	1100	1000	750	100°	56x50	SLD631052BB	8031453032838	10/100	
7,0	110	GU10		4000	1100	1000	750	100°	56x50	SLD631053B	8031453032845	10/100	
7,0	110	GU10		6500	1100	1000	750	100°	56x50	SLD631051B	8031453032814	10/100	



LED GU10 - 110° 220-240V

BTL CATEGORIA SCONTO 21

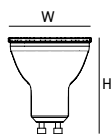

W	W=	BASE	K	lm	lm	cd		H x W mm	CODICE	EAN			
4,9	57	GU10		2700	560	535	250	110°	54x50	SLD630752B	8031453018610	10/100	
4,9	57	GU10		3000	560	535	250	110°	54x50	SLD630752BB	8031453019686	10/100	
4,9	57	GU10		4000	560	535	250	110°	54x50	SLD630753B	8031453018627	10/100	
4,9	57	GU10		6500	560	535	250	110°	54x50	SLD630751B	8031453018603	10/100	
7,1	61	GU10		2700	830	670	300	100°	57x50	SLD630952B	8031453023065	10/100	
7,1	61	GU10		3000	830	670	300	100°	57x50	SLD630952BB	8031453023072	10/100	
7,1	61	GU10		4000	830	670	300	100°	57x50	SLD630953B	8031453023089	10/100	
7,1	61	GU10		6500	830	670	300	100°	57x50	SLD630951B	8031453023058	10/100	



LED GU10 DIMMERABILE 220-240V

BTL CATEGORIA SCONTO 21

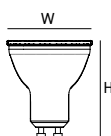

W	W=	BASE	K	lm	lm	cd		H x W mm	CODICE	EAN			
5,7	70	GU10		3000	600	500	500	60°	54x50	SLD630842D	8031453013554	10/100	
5,7	81	GU10		4000	590	580	540	60°	54x50	SLD630843D	8031453018665	10/100	

LED GU10 ALL-GLASS FASCIO STRETTO

BTL CATEGORIA SCONTO 21

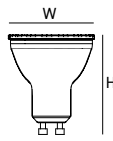

IP 20

15.000 h

15.000



W	W=	BASE	K	lm	lm	cd		H x W mm	CODICE	EAN		
5,0	50	GU10	3000	500	450	2300	15°	53x50	SLD620512	8031453028893	10/100	F
5,0	50	GU10	4000	500	450	2350	15°	53x50	SLD620513	8031453028909	10/100	F

LED GU10 ALL-GLASS H 220-240V

NEW

BTL CATEGORIA SCONTO 21

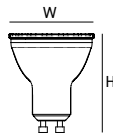

IP 20

50.000 h

50.000



W	W=	BASE	K	lm	lm	cd		H x W mm	CODICE	EAN		
4,7	100	GU10	3000	780	750	1350	36°	53x50	SLH620532	8031453034702	10/100	B
4,7	100	GU10	4000	890	850	1400	36°	53x50	SLH620533	8031453034719	10/100	A
4,7	100	GU10	3000	890	850	450	100°	53x50	SLH620552	8031453034726	10/100	A
4,7	100	GU10	4000	890	850	450	100°	53x50	SLH620553	8031453034733	10/100	A



LED GU10 ALL-GLASS 220-240V

BTL CATEGORIA SCONTO 21

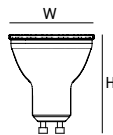

IP 20

15.000 h

40.000



W	W=	BASE	K	lm	lm	cd		H x W mm	CODICE	EAN		
6,2	71	GU10	3000	600	505	1450	24°	59x50	SLD620722	8031453023737	10/100	F
4,0	50	GU10	3000	390	345	750	36°	52x50	SLD620532	8031453020507	10/100	F
5,5	75	GU10	3000	575	535	900	36°	54x50	SLD620732	8031453020514	10/100	E
5,5	75	GU10	3000	600	535	385	60°	52x50	SLD620742	8031453019747	10/100	E
5,5	75	GU10	3000	575	500	240	110°	52x50	SLD620752	8031453019754	10/100	F

LED GU10 ALTA TEMPERATURA 220-240V

BTL CATEGORIA SCONTO 21

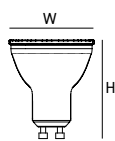

IP 20

10.000h

20.000



W	W=	BASE	K	lm	lm	cd		H x W mm	CODICE	EAN			
4,0	70	GU10		3000	560	500	950	36°	53x50	SLD620432HT	8031453028749	10/100	
4,0	70	GU10		4000	560	500	950	36°	53x50	SLD620433HT	8031453028756	10/100	
4,0	70	GU10		6500	560	500	950	36°	53x50	SLD620431HT	8031453028732	10/100	
4,0	70	GU10		3000	560	500	540	60°	53x50	SLD620442HT	8031453028770	10/100	
4,0	70	GU10		4000	560	500	540	60°	53x50	SLD620443HT	8031453028787	10/100	
4,0	70	GU10		6500	560	500	540	60°	53x50	SLD620441HT	8031453028763	10/100	
4,0	42	GU10		3000	500	-	-	120°	55x50	SLD620452HT	8031453028800	10/100	
4,0	42	GU10		4000	500	-	-	120°	55x50	SLD620453HT	8031453028817	10/100	
4,0	42	GU10		6500	500	-	-	120°	55x50	SLD620451HT	8031453028794	10/100	

LED GU10 ALL-GLASS DIMMERABILE 220-240V

BTL CATEGORIA SCONTO 21

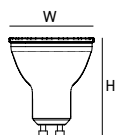

IP 20

25.000h

40.000



W	W=	BASE	K	lm	lm	cd		H x W mm	CODICE	EAN			
3,6	50	GU10		2700	420	345	750	36°	54x50	SLD620532BD	8031453031800	10/100	
3,6	50	GU10		3000	440	345	750	36°	52x50	SLD620532D	8031453019761	10/100	
5,5	75	GU10		2700	635	535	900	36°	54x50	SLD620732BD	8031453031817	10/100	
5,5	75	GU10		3000	635	535	900	36°	54x50	SLD620732D	8031453023935	10/100	



LED MR11 AC/DC 12V

BTL CATEGORIA SCONTO 21

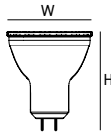

_ Si consiglia l'uso di alimentatori LED in DC o trasformatori ferromagnetici. Nel caso di trasformatori elettronici in AC verificare il corretto funzionamento ed i valori di corrente e tensione

_ We recommend the use of LED DC power supplies or ferromagnetic transformers. In the case of AC electronic transformers, check correct operation and the current



W	W=	BASE	K	lm	lm	cd		H x W mm	CODICE	EAN		
2,3	21	GU4	2700	230	200	500	36°	40x34	SLD660332	8031453017538	10/100	



LED MR16 AC/DC 12V

BTL CATEGORIA SCONTO 21

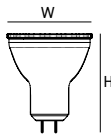

_ Si consiglia l'uso di alimentatori LED in DC o trasformatori ferromagnetici. Nel caso di trasformatori elettronici in AC verificare il corretto funzionamento ed i valori di corrente e tensione

_ We recommend the use of LED DC power supplies or ferromagnetic transformers. In the case of AC electronic transformers, check correct operation and the current



W	W=	BASE	K	lm	lm	cd		H x W mm	CODICE	EAN		
6,9	43	GU5.3	2700	560	500	540	60°	48x50	SLD650742B	8031453018641	10/100	
6,9	43	GU5.3	4000	560	500	540	60°	48x50	SLD650743B	8031453018658	10/100	
6,9	43	GU5.3	6500	560	520	540	60°	48x50	SLD650741B	8031453018634	10/100	



LED MR16 ALL-GLASS AC/DC 12V

BTL CATEGORIA SCONTO 21

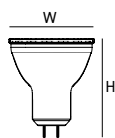

IP 20

15.000h

40.000



W	W=	BASE	K	lm	lm	cd		H x W mm	CODICE	EAN		
6,2	38	GU5.3	3000	500	400	450	60°	45x50	SLD670642	8031453019778	10/100	A++ G



LED MR16 ALL-GLASS DIMMERABILE AC/DC 12V

BTL CATEGORIA SCONTO 21

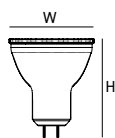

IP 20

25.000h

40.000



W	W=	BASE	K	lm	lm	cd		H x W mm	CODICE	EAN		
4,9	35	GU5.3	3000	470	360	510	60°	45x50	SLD670642D	8031453021405	10/100	A++ G



LED PAR30 WATERPROOF IP65 DIMMERABILE 220-240V

BTL CATEGORIA SCONTO 21

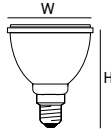

W	W=	BASE	K	lm	lm		H x W mm	CODICE	EAN		
9,5	75	E27	3000	870	800	40°	90x95	SLD551022D	8031453026035	40	
9,5	75	E27	4000	870	800	40°	90x95	SLD551023D	8031453026042	40	



LED PAR38 WATERPROOF IP65 DIMMERABILE 220-240V

BTL CATEGORIA SCONTO 21

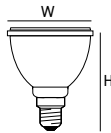

W	W=	BASE	K	lm	lm		H x W mm	CODICE	EAN		
16,0	120	E27	3000	1540	1400	40°	133x121	SLD561622D	8031453026059	20	
16,0	120	E27	4000	1540	1400	40°	133x121	SLD561623D	8031453026066	20	

LED BISPINA G4 AC/DC 12V

BTL CATEGORIA SCONTO 21



_ Si consiglia l'uso di alimentatori LED in DC o trasformatori ferromagnetici. Nel caso di trasformatori elettronici in AC verificare il corretto funzionamento ed i valori di corrente e tensione

_ We recommend the use of LED DC power supplies or ferromagnetic transformers. In the case of AC electronic transformers, check correct operation and the current



W	W=	BASE	K	lm		H x W mm	CODICE	EAN		
1,0	-	G4	2700	110	320°	37,5x9,7	SLD8601X2	8031453017385	10	
1,0	-	G4	4000	110	320°	37,5x9,7	SLD8601X3	8031453017408	10	
2,5	-	G4	2700	250	320°	46x13	SLD8603X2	8031453017422	10	
2,5	-	G4	4000	250	320°	46x13	SLD8603X3	8031453017521	10	

LED BISPINA G4 SATINATA AC/DC 12V

BTL CATEGORIA SCONTO 21



_ Si consiglia l'uso di alimentatori LED in DC o trasformatori ferromagnetici. Nel caso di trasformatori elettronici in AC verificare il corretto funzionamento ed i valori di corrente e tensione

_ We recommend the use of LED DC power supplies or ferromagnetic transformers. In the case of AC electronic transformers, check correct operation and the current



W	W=	BASE	K	lm		H x W mm	CODICE	EAN		
1,5	-	G4	2700	180	320°	36x10	SLD8202X2	8031453012564	10	
1,5	-	G4	4000	180	320°	36x10	SLD8202X3	8031453014933	10	

LED BISPINA G4 CHIARA AC/DC 12V

BTL CATEGORIA SCONTO 21



_ Si consiglia l'uso di alimentatori LED in DC o trasformatori ferromagnetici. Nel caso di trasformatori elettronici in AC verificare il corretto funzionamento ed i valori di corrente e tensione

_ We recommend the use of LED DC power supplies or ferromagnetic transformers. In the case of AC electronic transformers, check correct operation and the current



W	W=	BASE	K	lm		H x W mm	CODICE	EAN		
1,8	-	G4	3000	180	305°	38x13	SLD8902X2	8031453029388	20/200	
1,8	-	G4	4000	180	305°	38x13	SLD8902X3	8031453029395	20/200	
2,4	-	G4	3000	280	305°	44x13	SLD8903X2	8031453029401	20/200	
2,4	-	G4	4000	280	305°	44x13	SLD8903X3	8031453029418	20/200	



LED G9 ALL-GLASS 220-240V

BTL CATEGORIA SCONTO 21

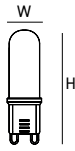

IP 20

20.000h

20.000



W	W=	BASE	K	lm		H x W mm	CODICE	EAN		
2.2	-	G9	3000	250	330°	53x15	SLD8702X2S	8031453025342	20/200	
2.2	-	G9	4000	250	330°	53x15	SLD8702X3S	8031453025359	20/200	
4.2	-	G9	3000	470	330°	56x18	SLD8704X2S	8031453025366	20/200	
4.2	-	G9	4000	470	330°	56x18	SLD8704X3S	8031453025373	20/200	



LED G9 220-240V

BTL CATEGORIA SCONTO 21

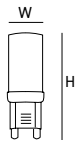

IP 20

25.000h

40.000



W	W=	BASE	K	lm		H x W mm	CODICE	EAN		
4.5	-	G9	3000	500	320°	54x19	SLD8505X2	8031453022891	10	
4.5	-	G9	4000	500	320°	54x19	SLD8505X3	8031453022907	10	
7.0	-	G9	3000	700	320°	70x21	SLD8507X2	8031453025427	10	
7.0	-	G9	4000	700	320°	70x21	SLD8507X3	8031453025434	10	



LED G9 DIMMERABLE 220-240V

BTL CATEGORIA SCONTO 21

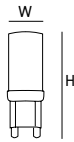

W	W=	BASE	K	lm		H x W mm	CODICE	EAN		
4,0	-	G9	3000	400	320°	54x19	SLD8505X2D	8031453022914	10	



LED G9 COB 220-240V

BTL CATEGORIA SCONTO 21



W	W=	BASE	K	lm		H x W mm	CODICE	EAN		
3,8	-	G9	3000	470	320°	60x20	SLD8804X2	8031453024888	20/400	
3,8	-	G9	4000	470	320°	60x20	SLD8804X3	8031453024895	20/400	



LED LINEARE R7S 220-240V

BTL CATEGORIA SCONTO 21

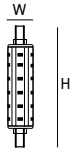

IP 20

15.000h

40.000



W	W=	BASE	K	lm		H x W mm	CODICE	EAN		
10,7	-	R7s	3000	1521	130°	118x22	SLD9511X2	8031453025489	10/50	
10,7	-	R7s	4000	1521	130°	118x22	SLD9511X3	8031453025496	10/50	



LED LINEARE R7S DIMMERABILE 220-240V

BTL CATEGORIA SCONTO 21

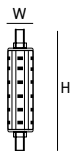

IP 20

15.000h

40.000



W	W=	BASE	K	lm		H x W mm	CODICE	EAN		
8,2	-	R7s	3000	1055	130°	118x22	SLD9508X2D	8031453025472	10/50	



LED LINEARE R7S 78MM 220-240V

BTL CATEGORIA SCONTO 21

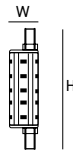

IP 20

15.000h

10.000



W	W=	BASE	K	lm		H x W mm	CODICE	EAN		
8,2	-	R7s	3000	1055	360°	78x29	SLD9610X2	8031453019150	10/50	



LED LINEARE R7S 2000LM DIMMERABILE 220-240V

BTL CATEGORIA SCONTO 21

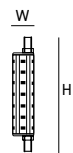

IP 20

25.000h

15.000



W	W=	BASE	K	lm		H x W mm	CODICE	EAN		
15,5	-	R7s	3000	2000	360°	118x29	SLD9716X2D	8031453019167	10/50	
15,5	-	R7s	4000	2000	360°	118x29	SLD9716X3D	8031453020521	10/50	



PL ALC LED 220-240V

BTL CATEGORIA SCONTO 21



IP 20

30.000h

15.000



W	W=	BASE	K	lm		H x W mm	CODICE	EAN		
11,5	-	G24d	3000	1000	120°	152x35	SLD751052	8031453022112	10/50	
11,5	-	G24d	4000	1000	120°	152x35	SLD751053	8031453022129	10/50	



PL AL LED 220-240V

BTL CATEGORIA SCONTO 21



IP 20

30.000h

15.000



W	W=	BASE	K	lm		H x W mm	CODICE	EAN		
5,7	-	G23	3000	460	180°	167x32	SLD760552	8031453022136	10/50	
5,7	-	G23	4000	510	180°	167x32	SLD760553	8031453022143	10/50	
7,2	-	G23	3000	670	180°	228x32	SLD760752	8031453022150	10/50	
7,2	-	G23	4000	720	180°	228x32	SLD760753	8031453022167	10/50	



PL ALL LED 220-240V

BTL CATEGORIA SCONTO 21



IP 20

25.000h

25.000



W	W=	BASE	K	lm		H x W mm	CODICE	EAN		
8,0	-	2G11	4000	1000	140°	224x43,6	SLD770853	8031453031688	10/50	
12,0	-	2G11	4000	1500	140°	319x43,6	SLD771253	8031453031695	10/50	
16,5	-	2G11	4000	2100	140°	398x43,6	SLD771753	8031453031701	10/50	
24,0	-	2G11	4000	3400	140°	521x43,6	SLD772453	8031453031718	10/50	



LED AR111 CRI>97 DIMMERABILE AC/DC 12V

BTL CATEGORIA SCONTO 21

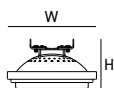

_ G53: Si consiglia l'uso di alimentatori LED in DC o trasformatori ferromagnetici. Nel caso di trasformatori elettronici in AC verificare il corretto funzionamento ed i valori di corrente e tensione.

_ G53: The use of LED DC power supplies or ferromagnetic transformers is recommended. In the case of AC electronic transformers, check the correct operation on the current.



W	W=	BASE	K	lm		H x W mm	CODICE	EAN		
13,0	-	G53	3000	1100	40°	61x111	SLD5713329	8031453024666	20	
13,0	-	G53	4000	1100	40°	61x111	SLD5713339	8031453024673	20	



LED GX53 220-240V

BTL CATEGORIA SCONTO 21

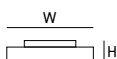

W	W=	BASE	K	lm		H x W mm	CODICE	EAN		
6,5	-	GX53	3000	650	110°	25x75	ELD770752	8031453020576	10/50	
6,5	-	GX53	4000	650	110°	25x75	ELD770753	8031453020583	10/50	
8,0	-	GX53	3000	900	120°	25x75	ELD770852	8031453026431	10/50	
8,0	-	GX53	4000	900	120°	25x75	ELD770853	8031453026448	10/50	



LED LINEARLINE 300MM 220-240V

BTL CATEGORIA SCONTO 21

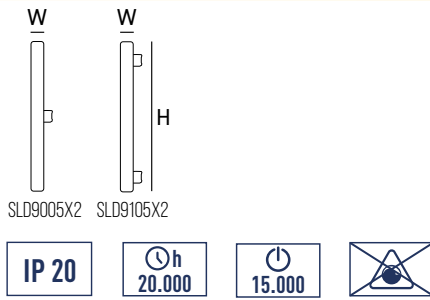

W	W=	BASE	K	lm		H x W mm	CODICE	EAN		
5,0	-	S14d	2700	450	150°	300x49	SLD9005X2	8031453011659	10/50	
5,0	-	S14s	2700	300	200°	300x48	SLD9105X2	8031453011710	10/50	



LED LINEARLINE 500MM 220-240V

BTL CATEGORIA SCONTO 21

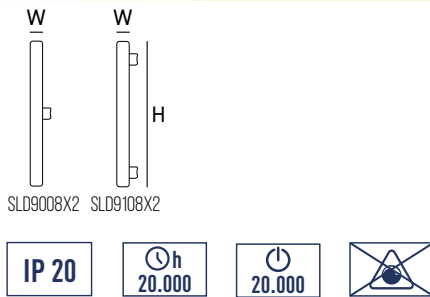

W	W=	BASE	K	lm		H x W mm	CODICE	EAN		
7,5	-	S14d	2700	700	150°	500x48	SLD9008X2	8031453011680	10/50	
7,5	-	S14s	2700	700	150°	500x48	SLD9108X2	8031453011741	10/50	



LED LINEARLINE 1000MM 220-240V

BTL CATEGORIA SCONTO 21

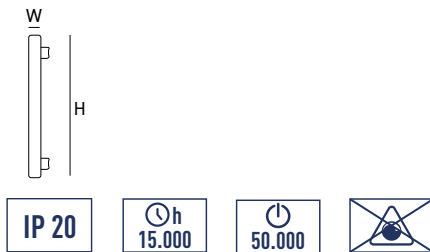

W	W=	BASE	K	lm		H x W mm	CODICE	EAN		
11,0	-	S14s	2700	1055	200°	1000x30	SLD9114X2	8031453015602	30	



LAMPADA ELLITTICA SMD HID 220-240V

BTL CATEGORIA SCONTO 21

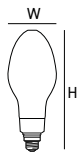

W	W=	BASE	K	lm		H x W mm	CODICE	EAN		
52,0	-	E27	4000	7600	330°	264x108	SLD9975X3	8031453028725	20	
52,0	-	E40	4000	7600	330°	274x108	SLD9975X3E40	8031453028718	20	



LAMPADA ELLISSOIDALE ALTA POTENZA HID 220-240V

BTL CATEGORIA SCONTO 21

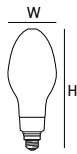

_ Sistema di protezione da sbalzi di tensione fino a 4kV _ Power surge protection system up to 4kV



W	W=	BASE	K	lm		H x W mm	CODICE	EAN		
36,0	-	E27	2000	4200	320°	229x90	SLD9850X2W	8031453024949	12	-
36,0	-	E27	3000	5000	320°	229x90	SLD9850X2	8031453024932	12	
34,0	-	E27	4000	5000	330°	230x90	SLD9850X3	8031453028541	6	
36,0	-	E27	5000	5000	320°	229x90	SLD9850X1	8031453024956	12	
30,0	-	E27	2000	3200	320°	195x75	SLD9840X2W	8031453024918	12	-
30,0	-	E27	3000	4000	320°	195x75	SLD9840X2	8031453024901	12	
28,0	-	E27	4000	4000	330°	195x75	SLD9840X3	8031453028534	6	
34,0	-	E40	3000	5000	330°	215x90	SLD9850X2E40	8031453028558	6	
34,0	-	E40	4000	5000	330°	215x90	SLD9850X3E40	8031453028565	6	

LAMPADA TUBOLARE ALTA POTENZA HID 220-240V

BTL CATEGORIA SCONTO 21



IP 65

25.000h

20.000



W	W=	BASE	K	lm		H x W mm	CODICE	EAN		
28,0	-	E27	3000	4500	330°	223x46	SLD9845X2	8031453028572	6	
28,0	-	E27	4000	4500	330°	223x46	SLD9845X3	8031453028589	6	
38,0	-	E40	3000	7200	330°	207x46	SLD9875X2E40	8031453028596	6	
38,0	-	E40	4000	7500	330°	207x46	SLD9875X3E40	8031453028602	6	





GOCCIA OPALE CON SENSORE CREPUSCOLARE 220-240V

BTL CATEGORIA SCONTO 21

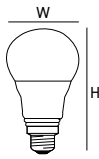

_ Doppio sensore crepuscolare sul corpo della lampada

_ Double dusk sensor on the body of the lamp

IP 20

25.000 h

30.000



AUTOMATIC ON-OFF

W	W=	BASE	K	lm		H x W mm	CODICE	EAN		
10,7	75	E27	2700	1060	200°	120x60	LESENS10X2B	8031453019174	10/50	
10,7	75	E27	4000	1060	200°	120x60	LESENS10X3B	8031453019181	10/50	



GOCCIA OPALE CON SENSORE DI MOVIMENTO E CREPUSCOLARE 220-240V

AGGIORNATO

BTL CATEGORIA SCONTO 21

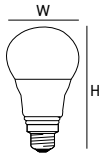
 _ Rilevato il movimento la lampada si accende per 45 secondi al 100% dell'emissione luminosa e per i successivi 15 secondi passa al 50% del flusso. Se non viene rilevato ulteriore movimento la lampada si spegne.
 _ Sensore crepuscolare

 _ When movement is detected the lamp turns ON at 100% luminous flux for 45 seconds, for the following 15 seconds the flux reduces at 50% of emission. If no other movement is detected, the lamp turns OFF
 _Dusk sensor

IP 20

15.000 h

30.000



AUTOMATIC ON-OFF

W	W=	BASE	K	lm		H x W mm	CODICE	EAN		
9,5	75	E27	2700	1060	200°	120x60	SLD1011X2M	8031453026424	10/50	



GOCCIA OPALE 12/24V AC/DC

BTL CATEGORIA SCONTO 21

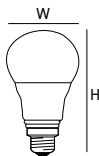

_ Si consiglia l'uso di alimentatori LED in DC o trasformatori ferromagnetici. Nel caso di trasformatori elettronici in AC verificare il corretto funzionamento ed i valori di corrente e tensione.

_ We recommend the use of LED DC power supplies or ferromagnetic transformers. In case of AC electronic transformers, check correct operation and electric parameters.

IP 20

20.000 h

20.000



W	W=	BASE	K	lm		H x W mm	CODICE	EAN		
8,0	60	E27	2700	806	180°	112x60	SLD1009X2DC	8031453019198	10/50	
8,0	60	E27	4000	806	180°	112x60	SLD1009X3DC	8031453032227	10/50	
8,5	75	E27	2700	1055	180°	120x60	SLD1009X2DC2	8031453026400	10/50	

GOCCIA LED FROST PER CELLA FRIGORIFERA -40 °C 220-240V

BTL CATEGORIA SCONTO 21

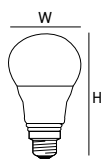

W	W=	BASE	K	lm		H x W mm	CODICE	EAN		
5,5	40	E27	2800	470	240°	102x60	4711394	6435200192097	10/60	
8,5	60	E27	4000	840	200°	102x60	4711395	6435200192110	10/60	
8,0	60	E27	2800	810	200°	102x60	4711503	6435200203779	10/100	
10,5	75	E27	4000	1055	240°	120x60	4711504	6435200203793	10/100	

GOCCIA LED ANTIZANZARE 220-240V

BTL CATEGORIA SCONTO 21

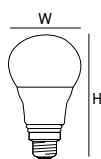

_ Lampada con funzione color switch 4000K oppure luce gialla antizanzare.

_ Lamp with 4000K color switch function or yellow anti-mosquito light



W	W=	BASE	K	lm		H x W mm	CODICE	EAN		
8,0	60	E27	4000	806	220°	110x60	ELD1008X3AM	8031453020002	10/50	

GOCCIA LED PER SAUNA +60 °C 220-240V

BTL CATEGORIA SCONTO 21

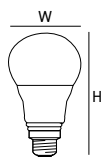

W	W=	BASE	K	lm		H x W mm	CODICE	EAN		
4,5	40	E27	2800	470	240°	109x61	4711528	6435200206367	10/100	



GOCCIA LED SURGE PROTECTION 220-240V

BTL CATEGORIA SCONTO 21

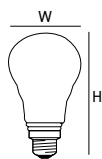

_ Sistema di protezione da sbalzi di tensione fino a 2,5kV

_ Power surge protection system up to 2.5kV



W	W=	BASE	K	lm		H x W mm	CODICE	EAN		
9,5	75	E27	2700	1055	180°	109x60	SLD1011X2SP	8031453021221	10/50	
9,5	75	E27	4000	1055	180°	109x60	SLD1011X3SP	8031453021238	10/50	



LED PLANT PAR20 PER CRESCITA PIANTE 220-240V

BTL CATEGORIA SCONTO 21

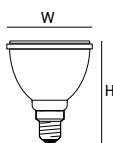

W	W=	BASE	K	lm		cd		H x W mm	CODICE	EAN			
6,2	-	E14	3500	400		400	1350	40°	90x63	4713401	6435200235299	10/100	



LED PLANT PAR30 PER CRESCITA PIANTE 220-240V

BTL CATEGORIA SCONTO 21

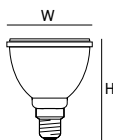

W	W=	BASE	K	lm		cd		H x W mm	CODICE	EAN			
9,5	-	E27	3500	800		800	2300	40°	115x95	4711773	6435200231246	10/40	



LAMPADE CCT 220-240V

NEW

BTL CATEGORIA SCONTO 21



W	W=	BASE	K	lm	cd		H x W mm	CODICE	EAN		
9,0	60	E27	<input type="checkbox"/> 3000 <input type="checkbox"/> 4000 <input type="checkbox"/> 6500	806	-	200°	108x60	SMM1008XK	8031453030599	10/100	
7,0	50	GU10	<input type="checkbox"/> 3000 <input type="checkbox"/> 4000 <input type="checkbox"/> 6500	700	250	110°	55x50	SMM63055K	8031453030582	10/100	
8,0	60	E27	<input type="checkbox"/> 3000 <input type="checkbox"/> 4000 <input type="checkbox"/> 6500	806	-	220°	116x37	SMM7408XK	8031453030575	10/100	

TUBO LED VETRO T8 A-CLASS 220-240V

BTL CATEGORIA SCONTO 21

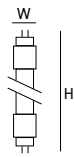

_ Starter incluso
_ Non compatibile con reattori elettronici

_ Starter included
_ Not compatible with electronic ballast

IP 20

50.000h

200.000



PF >0,9



W	W=	BASE	K	lm		H x W mm	CODICE	EAN		
12,0	-	G13	4000	2550	250°	1200x26	LT12123H	8031453028060	10	A
17,0	-	G13	4000	3600	250°	1500x26	LT15173H	8031453028077	10	A



TUBO LED VETRO T8 HIGH EFFICIENCY 220-240V

AGGIORNATO

BTL CATEGORIA SCONTO 21

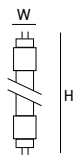

_ Starter non incluso
_ Non compatibile con reattori elettronici

_ Starter not included
_ Not compatible with electronic ballast

IP 20

50.000h

200.000



PF >0,9

W	W=	BASE	K	lm		H x W mm	CODICE	EAN			
9,0	-	G13	4000	1350	250°	600x26	LT06093H	8031453025397	25	D	
9,0	-	G13	6500	1350	250°	600x26	LT06091H	8031453025380	25	D	
17,5	-	G13	4000	2600	250°	1200x26	LT12183H	8031453022549	25	D	
17,5	-	G13	6500	2600	250°	1200x26	LT12181H	8031453025403	25	D	
22,0	-	G13	4000	3300	250°	1500x26	LT15243H	8031453022556	25	D	
22,0	-	G13	6500	3300	250°	1500x26	LT15241H	8031453025410	25	D	
NEW	26,5	-	G13	4000	4000	250°	1500x26	LT15273H	8031453034382	25	D
NEW	26,5	-	G13	6500	4000	250°	1500x26	LT15271H	8031453034375	25	D

TUBO LED VETRO T8 220-240V AGGIORNATO

BTL CATEGORIA SCONTO 21

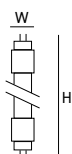

_ *Starter incluso solo per articoli
 LT06093E.1 - LT12183E.1 - LT15243E.1 (pack 10 pezzi)
 _ Non compatibile con reattori elettronici

_ *Starter included only for
 LT06093E.1 - LT12183E.1 - LT15243E.1 (10 pieces pack)
 _ Not compatible with electronic ballast

IP 20
30.000h
200.000
PF >0,9

W	W=	BASE	K	lm		H x W mm	CODICE	EAN		
7,5	-	G13	3000	900	250°	600x26	LT06092E	8031453023157	25	
7,5	-	G13	4000	900	250°	600x26	LT06093E	8031453020606	25	
7,5	-	G13	4000	900	250°	600x26	LT06093E.1 *	8031453026127	10	
7,5	-	G13	6500	900	250°	600x26	LT06091E	8031453020590	25	
10,0	-	G13	4000	1200	250°	900x26	LT09133E	8031453022099	25	
10,0	-	G13	6500	1200	250°	900x26	LT09131E	8031453022082	25	
15,0	-	G13	3000	1800	250°	1200x26	LT12182E	8031453023164	25	
15,0	-	G13	4000	1800	250°	1200x26	LT12183E	8031453020620	25	
15,0	-	G13	4000	1800	250°	1200x26	LT12183E.1 *	8031453026134	10	
15,0	-	G13	6500	1800	250°	1200x26	LT12181E	8031453020613	25	
19,0	-	G13	3000	2300	250°	1500x26	LT15242E	8031453023171	25	
19,0	-	G13	4000	2300	250°	1500x26	LT15243E	8031453020644	25	
19,0	-	G13	4000	2300	250°	1500x26	LT15243E.1 *	8031453026141	10	
19,0	-	G13	6500	2300	250°	1500x26	LT15241E	8031453020637	25	

TUBO LED VETRO T8 SE 220-240V
NEW

BTL CATEGORIA SCONTO 21

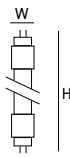

_ Starter non incluso
 _ Non compatibile con reattori elettronici

_ Starter not included
 _ Not compatible with electronic ballast



W	W=	BASE	K	lm		H x W mm	CODICE	EAN		
9,0	-	G13	4000	900	250°	600x26	LT06093SE	8031453034320	25	
9,0	-	G13	6500	900	250°	600x26	LT06091SE	8031453034313	25	
17,5	-	G13	4000	1800	250°	1200x26	LT12183SE	8031453034344	25	
17,5	-	G13	6500	1800	250°	1200x26	LT12181SE	8031453034337	25	
22,0	-	G13	4000	2300	250°	1500x26	LT15223SE	8031453034368	25	
22,0	-	G13	6500	2300	250°	1500x26	LT15221SE	8031453034351	25	

TUBO LED VETRO T8 FOOD 220-240V

BTL CATEGORIA SCONTO 21

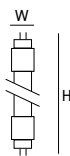

_ Tubo per carni - starter incluso
 _ Non compatibile con reattori elettronici

_ Meat light tube - starter included
 _ Not compatible with electronic ballast



W	W=	BASE	K	lm		H x W mm	CODICE	EAN		
5,2	-	G13	3300	500	190°	600x27	LT0605FL	8031453028336	10	-
7,9	-	G13	3300	750	200°	900x27	LT0908FL	8031453022389	10	-
11,6	-	G13	3300	1100	200°	1200x27	LT1212FL	8031453022396	10	-
17,9	-	G13	3300	1700	200°	1500x27	LT1518FL	8031453022402	10	-

TUBO LED VETRO T5 - MAINS 220-240V

BTL CATEGORIA SCONTO 21

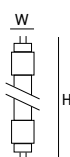

_ Non compatibile con reattori elettronici

_ *Not compatible with electronic ballast*

W	W=	BASE	K	lm		H x W mm	CODICE	EAN		
8,0	-	G5	3000	1200	250°	549x18	L506082AC	8031453031947	10	
8,0	-	G5	4000	1200	250°	549x18	L506083AC	8031453031954	10	
12,0	-	G5	3000	1800	250°	849x18	L509122AC	8031453031961	10	
12,0	-	G5	4000	1800	250°	849x18	L509123AC	8031453031978	10	
16,0	-	G5	3000	2400	250°	1149x18	L512162AC	8031453031985	10	
16,0	-	G5	4000	2400	250°	1149x18	L512163AC	8031453031992	10	
20,0	-	G5	3000	3000	250°	1449x18	L515202AC	8031453032005	10	
20,0	-	G5	4000	3000	250°	1449x18	L515203AC	8031453032012	10	

CIRCOLINE T9 LED 220-240V NEW

BTL CATEGORIA SCONTO 21

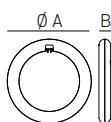

_ Starter incluso
 _ Non compatibile con reattori elettronici
 _ Fissaggio magnetico

_ *Starter included*
 _ *Not compatible with electronic ballast*
 _ *Magnetic fixing*

W	W=	BASE	K	lm		A x B mm	CODICE	EAN		
14	-	G10Q	3000 4000 6000	1600	180°	215x32	LC22K	8031453034672	20	
19	-	G10Q	3000 4000 6000	2200	180°	300x32	LC32K	8031453034689	20	
24	-	G10Q	3000 4000 6000	2700	180°	400x32	LC40K	8031453034696	10	

STARTER PER TUBI T8 A LED

_ Non compatibile con circoline LED

_ *Not compatible with circular LED tube*

BTL CATEGORIA SCONTO 21



CODICE	EAN	IMBALLO
LTSTU2	8031453020651	25

SHOT
BOT LIGHTING

SORGENTI TRADIZIONALI
TRADITIONAL LIGHT SOURCES







LINEARE ENERGY SAVING R7S DIMMERABILE 230V

BTL CATEGORIA SCONTO 8

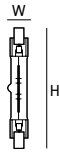

W	W=	BASE	K	lm		H x W mm	CODICE	EAN		
80	-	R7s	2900	1380	360°	79x9	J8079ES	6435200013873	20/100	
120	-	R7s	2900	2250	360°	79x9	J12079ES	6435200013323	20/100	
80	-	R7s	2900	1380	360°	119x9	J80ES	6435200015075	20/100	
120	-	R7s	2900	2250	360°	119x9	J120ES	6435200013835	20/100	



SPOT RAGGI INFRAROSSI

BTL CATEGORIA SCONTO 2

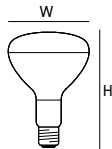

W	W=	BASE	K	lm		H x W mm	CODICE	EAN		
150	-	E27	-	-	-	175x125	R1150	8031453031770	5/30	-
250	-	E27	-	-	-	175x125	R1250	8031453031787	5/30	-



PICCOLA PERA CHIARA 230V

BTL CATEGORIA SCONTO 2

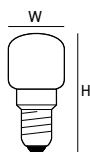

W	W=	BASE	K	lm		H x W mm	CODICE	EAN		
13	-	E14	2100	40	300°	56x25	PP05CM	6435200007285	50	-



PICCOLA PERA CHIARA PER FORNI 300 °C 230V

BTL CATEGORIA SCONTO 2

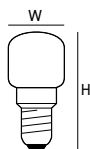

W	W=	BASE	K	lm		H x W mm	CODICE	EAN		
15	-	E14	2100	50	300°	50x22	PP15MFF240	6435200007292	50	-
25	-	E14	2200	120	300°	56x25	PP25MFF	6435200153425	50	-

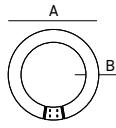
CIRCOLARI TRIFOSFORO T9

BTL CATEGORIA SCONTO 9

W	W=	BASE	K	lm		A x B mm	CODICE	EAN		
22	-	G10Q	4200	1350	-	210x30	LR222T	6435200014597	12	
22	-	G10Q	6500	1200	-	210x30	LR221T	6435200014580	12	
32	-	G10Q	4200	2300	-	305x30	LR322T	6435200014627	12	
32	-	G10Q	6500	2000	-	305x30	LR321T	6435200014610	12	
40	-	G10Q	4200	3200	-	406x30	LR402T	6435200014658	12	
40	-	G10Q	6500	2800	-	406x30	LR401T	6435200014641	12	

STARTER PER LAMPADE FLUORESCENTI 220/240V - 50/60Hz

BTL CATEGORIA SCONTO 17



	ALIMENTAZIONE	CODICE/TIPO	IMBALLO
Per lampade fluorescenti lineari da 4W a 20W (26-38 mm) circolari da 22W.	230 V - 50/60Hz	ST20	25
Per lampade fluorescenti lineari da 4W a 65W (26-38 mm) circolari da 22W a 40W.	230 V - 50/60Hz	ST65	25



NCK-G CERAMIC

BTL CATEGORIA SCONTO 7

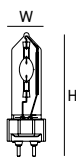

_ Lampada a ioduri metallici con tecnologia ceramica.
 _ Resa cromatica >90 per le 942 e >80 per le 830
 _ Durata di vita migliorata rispetto ad una tradizionale lampada ad ioduri

_ Metal halide lamp with ceramic technology.
 _ Color rendering > 90 for 942 and > 80 for 830
 _ Improved lifespan compared to a traditional iodide lamp

MHC

W	W=	BASE	K	lm		H x W mm	CODICE	EAN		
35	-	G12	3000	3500	-	90x15	NCKG35WW	-	25	-
35	-	G12	4200	3300	-	90x15	NCKG35NW	-	25	-
70	-	G12	3000	6800	-	90x20	NCKG70WW	-	25	-
70	-	G12	4200	6200	-	90x20	NCKG70NW	-	25	-
150	-	G12	3000	18000	-	90x20	NCKG150WW	-	25	-
150	-	G12	4200	15500	-	90x20	NCKG150NW	-	25	-



NCK-TC CERAMIC

BTL CATEGORIA SCONTO 7

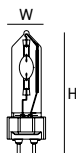

MHC

W	W=	BASE	K	lm		H x W mm	CODICE	EAN		
35	-	G8,5	3000	3300	-	85x14,5	NCKTC35WW	-	25	-
35	-	G8,5	4200	3500	-	85x14,5	NCKTC35NW	-	25	-
70	-	G8,5	3000	6800	-	85x14,5	NCKTC70WW	-	25	-
70	-	G8,5	4200	6700	-	85x14,5	NCKTC70NW	-	25	-



NACHROMA DOPPIO ATTACCO

BTL CATEGORIA SCONTO 7

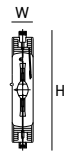

_ Lampada a ioduri metallici biattacco al quarzo.
 _ Adatta per reattore ai vapori di sodio ad alta pressione (RENA).
 _ Necessita di accenditore per lampade a ioduri metallici

_ Quartz double-ended metal halide lamp.
 _ Suitable for high pressure sodium vapor reactor (RENA)
 _ Requires igniter for metal halide lamps

MH

W	W=	BASE	K	lm		H x W mm	CODICE	EAN		
70	-	RX7s	3200	5700	-	115x19	NCDE70WW	-	10	-
70	-	RX7s	4200	5800	-	115x19	NCDE70NW	-	10	-
70	-	RX7s	5200	5200	-	115x19	NCDE70DW	-	10	-
150	-	RX7s-24	3200	13500	-	132x22	NCDE150WW	-	10	-
150	-	RX7s-24	4200	13500	-	132x22	NCDE150NW	-	10	-
150	-	RX7s-24	5200	13000	-	132x22	NCDE150DW	-	10	-



NACHROMA ELLISSOIALE DIFFONDENTE

BTL CATEGORIA SCONTO 7

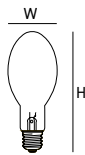

_ Lampada al sodio ad alta pressione ellissoidale con bulbo diffondente
 _ Adatta per reattore ai vapori di sodio ad alta pressione (RENA).
 _ Necessita di accenditore ad esclusione di NAE70SI
 _ NAE70SI disponibile su ordinazione

_ High pressure ellipsoidal sodium lamp with diffusing bulb
 _ Suitable for high pressure sodium vapor reactor (RENA)
 _ Requires igniter except NAE70SI
 _ NAE70SI available on request

MH

W	W=	BASE	K	lm		H x W mm	CODICE	EAN		
70	-	E27	2500	6100	-	156x70	NAES70	-	12	-
100	-	E40	2500	9500	-	186x75	NAES100	-	12	-
150	-	E40	2500	16700	-	227x90	NAES150	-	12	-



NATRALOX SUPER TUBOLARE TRASPARENTE

BTL CATEGORIA SCONTO 7



_ Lampada al sodio ad alta pressione tubolare con bulbo trasparente
 _ Adatta per reattore ai vapori di sodio ad alta pressione (RENA).
 _ Necessita di accenditore

_ Tubular high pressure sodium lamp with transparent bulb
 _ Suitable for high pressure sodium vapor reactor (RENA)
 _ Requires an igniter

HPS

W	W=	BASE	K	lm		H x W mm	CODICE	EAN		
70	-	E27	2500	6500	-	156x38	NATS70	-	12	-
100	-	E40	2500	10000	-	211x46	NATS100	-	12	-
150	-	E40	2500	17500	-	211x46	NATS150	-	12	-
250	-	E40	2500	33000	-	257x46	NATS250	-	12	-
400	-	E40	2500	54500	-	271x46	NATS400	-	12	-

SHOT

BOT LIGHTING

LAMPADE UVC

UVC LIGHT BULBS

INFORMAZIONI GENERALI

La radiazione ultravioletta è un metodo di sterilizzazione che usa la luce ultravioletta UVC con lunghezze d'onda comprese nella banda tra 280 e 100 nanometri, che modifica il DNA o l'RNA dei microorganismi come batteri, virus, acari ed altri, impedendo loro di riprodursi o di essere dannosi.

Utilizzare un dispositivo UV germicida in certi ambienti crea un effetto mortale su microorganismi patogeni, virus e muffe.

GENERAL INFORMATION

Ultraviolet radiation is a sterilization method that uses UVC ultraviolet light with wavelengths between 280 and 100 nanometers, which modifies the DNA or RNA of microorganisms such as bacteria, viruses, mites and others, preventing them from reproduce or be harmful.

Using a germicidal UV device creates a deadly effect on pathogenic microorganisms, viruses and molds.

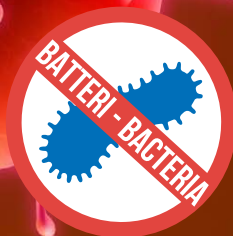

PL UVC

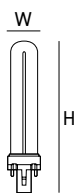

- _ Lunghezza d'onda nello spettro di emissione UVC (280 - 200nm)
- _ Vetro al quarzo
- _ Eliminazione rapida di Batteri, Virus, Muffe e Acari
- _ Nessuna produzione di ozono
- _ Compatibile con i ballast per lampade a fluorescenza
- _ Sistema HQ/HO alta emissione luminosa
- _ Funzionamento con alimentatore elettronico

- _ Wavelength in the UVC emission spectrum (280 - 200nm)
- _ Quartz glass
- _ Rapid elimination of Bacteria, Viruses, Molds and Mites
- _ No ozone production
- _ Compatible with ballasts for fluorescent lamps
- _ High light emission HQ / HO system
- _ Operation with electronic ballast

BTL CATEGORIA SCONTO 10

UVC

IP 20

8.000 h

W	LUNGHEZZA D'ONDA nm	BASE	TENSIONE V	H x W mm	CODICE	EAN	
9	253,7	G23	54-66	165x12	AL9TUV	-	50
36	253,7	2G11	98-118	391x43	ALL36TUV	-	50



TUBO T5 UVC

BTL CATEGORIA SCONTO 4

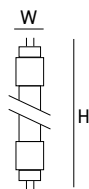

- _ Lunghezza d'onda nello spettro di emissione UVC (280 - 200nm)
- _ Vetro al quarzo
- _ Eliminazione rapida di Batteri, Virus, Muffe e Acari
- _ Nessuna produzione di ozono
- _ Compatibile con i ballast per lampade a fluorescenza
- _ Sistema HQ/HO alta emissione luminosa
- _ Funzionamento con alimentatore elettronico

- _ Wavelength in the UVC emission spectrum (280 - 200nm)
- _ Quartz glass
- _ Rapid elimination of Bacteria, Viruses, Molds and Mites
- _ No ozone production
- _ Compatible with ballasts for fluorescent lamps
- _ High light emission HQ / HO system
- _ Operation with electronic ballast

UVC **IP 20** 8.000h

W	LUNGHEZZA D'ONDA nm	BASE	TENSIONE V	H x W mm	CODICE	EAN	
6	253,7	G5	36-49	211x15	L6TG	-	10
8	253,7	G5	48-64	288x15	L8TG	-	25



TUBO T8 UVC

BTL CATEGORIA SCONTO 4

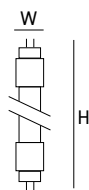

- _ Lunghezza d'onda nello spettro di emissione UVC (280 - 200nm)
- _ Vetro al quarzo
- _ Eliminazione rapida di Batteri, Virus, Muffe e Acari
- _ Nessuna produzione di ozono
- _ Compatibile con i ballast per lampade a fluorescenza
- _ Sistema HQ/HO alta emissione luminosa
- _ Funzionamento con alimentatore elettronico

- _ Wavelength in the UVC emission spectrum (280 - 200nm)
- _ Quartz glass
- _ Rapid elimination of Bacteria, Viruses, Molds and Mites
- _ No ozone production
- _ Compatible with ballasts for fluorescent lamps
- _ High light emission HQ / HO system
- _ Operation with electronic ballast

UVC **IP 20** 8.000h

W	LUNGHEZZA D'ONDA nm	BASE	TENSIONE V	H x W mm	CODICE	EAN	
15	253,7	G13	46-64	437x25	L15TG	-	50
30	253,7	G13	102-125	895x25	L30TG	-	50
40	253,7	G13	102-125	1200x25	L36TG	-	50





SHOT
BOT LIGHTING

**APPARECCHI DI ILLUMINAZIONE
TECNICO / PLAFONIERE**

LIGHTING FIXTURES
TECHNICAL / CEILING LAMPS



IRIS ROUND

BTL CATEGORIA SCONTO 23

Plafoniera CCT / CCT ceiling light

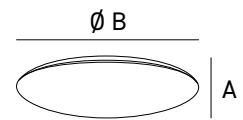

Dimensioni	A	B
1	58	260
2	55	320
3	60	380



- _ Plafoniera tonda con base in metallo e diffusore in tecnopolimero ad alta resistenza, ideale per interni
- _ Versatile e di facile installazione a soffitto e parete
- _ Flusso luminoso uniforme
- _ CCT selezionabile

- _ Round ceiling light with metal base and high-resistance technopolymer diffuser, ideal for indoor use
- _ Versatile and easy to install on ceiling and wall
- _ Uniform luminous flux
- _ Selectable CCT



W	K	LUMEN APPARECCHIO lm	LUMEN SORGENTE lm	MISURE	VARIANTE	CODICE	EAN		
12	<input type="checkbox"/> 3000 <input type="checkbox"/> 4000 <input type="checkbox"/> 6500	1000	1400	120° 1	-	IRIS12R	8031453031725	1/20	
18	<input type="checkbox"/> 3000 <input type="checkbox"/> 4000 <input type="checkbox"/> 6500	1400	2200	120° 2	-	IRIS18R	8031453031749	1/10	
24	<input type="checkbox"/> 3000 <input type="checkbox"/> 4000 <input type="checkbox"/> 6500	1800	2700	120° 3	-	IRIS24R	8031453031756	1/10	

IRIS SQUARED

Plafoniera CCT / CCT ceiling light

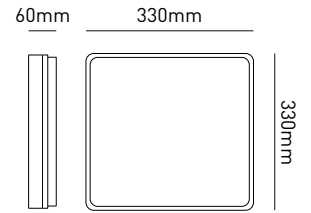

- _ Plafoniera quadrata per interni con base in metallo e diffusore in tecnopolimero ad alta resistenza
- _ Versatile e di facile installazione a soffitto e parete
- _ Flusso luminoso uniforme
- _ CCT selezionabile

- _ Squared ceiling light with metal base and high-resistance technopolymer diffuser, ideal for indoor use
- _ Versatile and easy to install on ceiling and wall
- _ Uniform luminous flux
- _ Selectable CCT



W	K	LUMEN APPARECCHIO lm	LUMEN SORGENTE lm		VARIANTE	CODICE	EAN		
24	<input type="checkbox"/> 3000 <input type="checkbox"/> 4000 <input type="checkbox"/> 6500	1800	2700	120°	-	IRIS24Q	8031453031763	1/10	

Plafoniera CCT / CCT ceiling light

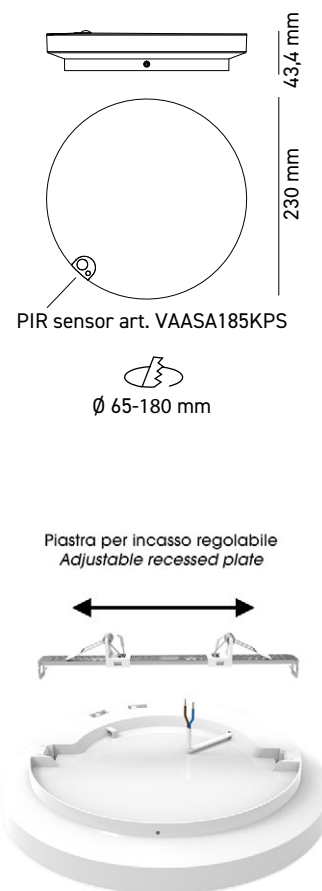
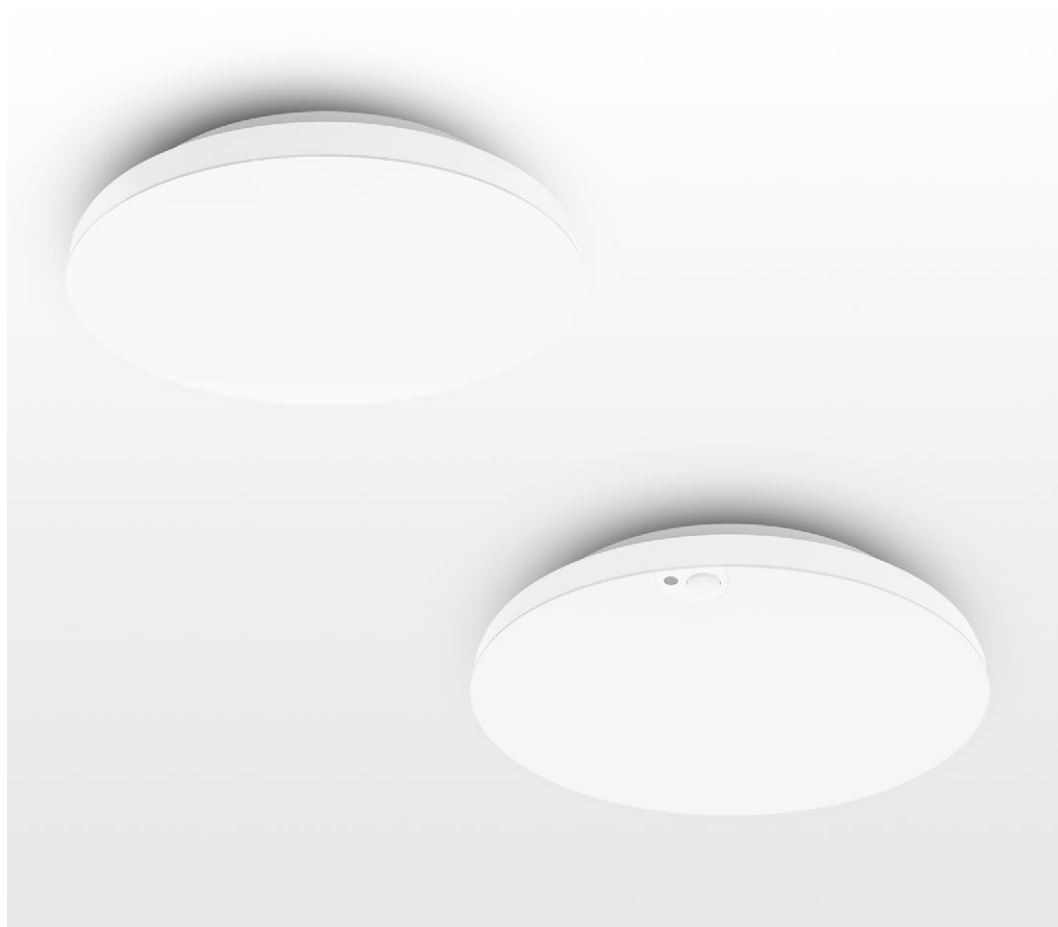

Plafoniera LED dal design minimal, con potenza e colore della luce regolabili per adattarsi a ogni esigenza. Una soluzione pratica e funzionale, pensata per offrire la massima flessibilità in tutti i contesti

Minimalist LED ceiling light with adjustable power and light color to suit any need. A practical and functional solution designed to provide maximum flexibility in any setting

- _ Plafoniera tonda in policarbonato adatta per ambienti interni, ideale per applicazioni a soffitto e parete
- _ Di facile installazione a soffitto o a parete grazie alla staffa in dotazione
- _ Montaggio ad incasso con staffa regolabile per foro 65-180mm
- _ Disponibile variante con sensore programmabile mediante dip-switch (ON/OFF, crepuscolare, durata)
- _ Potenza selezionabile tramite l'apposito selettore
- _ CCT selezionabile

- _ Round polycarbonate ceiling light suitable for indoor environments, ideal for ceiling and wall applications
- _ Easy to install on ceiling or wall thanks to the included bracket
- _ Recessed installation with adjustable bracket for 65-180mm cut-out
- _ Available version with programmable sensor via dip-switch (ON/OFF, twilight, duration)
- _ Power selectable via dedicated switch
- _ Selectable CCT



W	K	LUMEN APPARECCHIO lm	LUMEN SORGENTE lm		VARIANTE	CODICE	EAN			
6	2700	600	750	120°	-	VAASA185KP	8031453033002	1/20		
12	3000	1200	1450							
18	3500	1700	2100							
	4000									
	5000									
6	2700	600	750	120°	SENSORE / SENSOR *	VAASA185KPS	8031453033019	1/20		
12	3000	1200	1450							
18	3500	1700	2100							
	4000									
	5000									

VAASA BIG NEW

BTL CATEGORIA SCONTO 23

Plafoniera CCT / CCT ceiling light

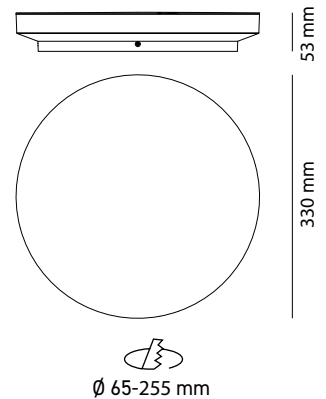

Piastra per incasso regolabile
Adjustable recessed plate

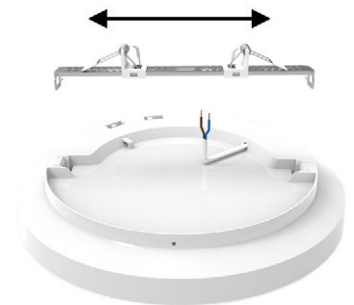

Plafoniera LED dal design minimal, con potenza e colore della luce regolabili per adattarsi a ogni esigenza. Una soluzione pratica e funzionale, pensata per offrire la massima flessibilità in tutti i contesti

Minimalist LED ceiling light with adjustable power and light color to suit any need. A practical and functional solution designed to provide maximum flexibility in any setting

- _ Plafoniera tonda in policarbonato adatta per ambienti interni, ideale per applicazioni a soffitto e parete
- _ Di facile installazione a soffitto o a parete grazie alla staffa in dotazione
- _ Montaggio ad incasso con staffa regolabile per foro 65-255mm
- _ Potenza selezionabile tramite l'apposito selettore
- _ CCT selezionabile

- _ Round polycarbonate ceiling light suitable for indoor environments, ideal for ceiling and wall applications
- _ Easy to install on ceiling or wall thanks to the included bracket
- _ Recessed installation with adjustable bracket for 65-255mm cut-out
- _ Power selectable via dedicated switch
- _ Selectable CCT



W	K	LUMEN APPARECCHIO lm	LUMEN SORGENTE lm		VARIANTE	CODICE	EAN		
8	2700	800	1050	120°	-	VAASA245KP	8031453033026	1/10	
16	3000	1600	2100						
24	3500	2200	2900						
	4000								
	5000								

JUPITER NEW

BTL CATEGORIA SCONTO 23

Plafoniera PIR / PIR ceiling light

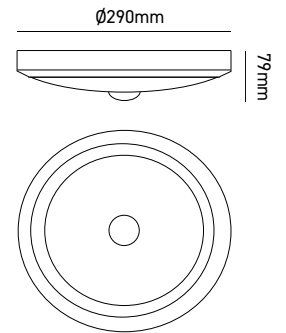

- _ Plafoniera tonda in policarbonato adatta per ambienti interni, ideale per applicazioni a soffitto e parete
- _ Sensore di presenza PIR regolabile: Tempo di accensione 5-90-180s Luminosità ambientale 5-50-2000lux
- _ Raggio di rilevamento 4m per installazione a 3m di altezza
- _ CCT selezionabile

- _ Round polycarbonate ceiling light suitable for indoor environments, ideal for ceiling and wall applications
- _ Adjustable PIR presence sensor: on-time 5-90-180 s, ambient brightness 5-50-2000 lux
- _ Detection range: 4 m with installation at 3 m height
- _ Selectable CCT



W	K	LUMEN APPARECCHIO lm	LUMEN SORGENTE lm		VARIANTE	CODICE	EAN			
18	<input type="checkbox"/> 3000 <input type="checkbox"/> 4000 <input type="checkbox"/> 6000	2000	2400	120°	-	JUPITER18PIR	8031453033729	1/8		

LINDA NEW

BTL CATEGORIA SCONTO 23

Plafoniera CCT / CCT ceiling light

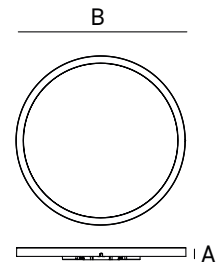

Dimensioni	A	B
1	22	283
2	22	383
3	24	483
4	24	583



DOWN LIGHT



ILLUMINAZIONE INDIRETTA
INDIRECT LIGHTING



BIEMISSIONE
DOUBLE EMISSION



LINDAKITS
Accessorio kit sospensione
Pendant kit accessory

- _ Plafoniera ultrasottile in policarbonato, ideale per interni
- _ Installazione facilitata con fissaggio a slitta
- _ Tre modalità di funzionamento: downlight, illuminazione indiretta e biemissione selezionabili tramite interruttore
- _ Illuminazione indiretta 3000K
- _ In opzione kit per installazione a sospensione
- _ Potenza e CCT selezionabili

- _ Ultra-slim polycarbonate ceiling light, ideal for indoor use
- _ Easy installation with slide-in mounting
- _ Three operating modes: downlight, indirect lighting, and bi-emission selectable via wall switch
- _ 3000K indirect lighting
- _ Optional suspension-mounting kit
- _ Power and CCT selectable

IP 40
220-240V
25.000h
-20°+40°
CCT
POWER

W	K	LUMEN APPARECCHIO lm	LUMEN SORGENTE lm	MISURE	VARIANTE	CODICE	EAN	Accessori	Efficienza Energetica
16	3000	1600	2300	120° 1	-	LINDA24KP	8031453034535	1/10	A++ E
20	4000	2000	3000						
24	6500	2400	3300						
24	3000	2400	3300	120° 2	-	LINDA32KP	8031453034573	1/10	A++ E
28	4000	2800	3800						
32	6500	3200	4400						
32	3000	3200	4400	120° 3	-	LINDA40KP	8031453034542	1/5	A++ E
36	4000	3600	5000						
40	6500	4000	5500						
40	3000	4000	5500	120° 4	-	LINDA48KP	8031453034580	1/5	A++ E
44	4000	4400	6200						
48	6500	4800	6800						
Accessorio kit sospensione / Pendant kit accessory						LINDAKITS	8031453034597	1	

COCO

BTL CATEGORIA SCONTO 23

Plafoniera / Ceiling light

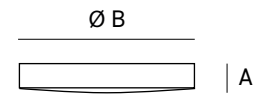

Dimensioni	A	B
1	65	310
2	65	360
3	65	410

- _ Plafoniera tonda in policarbonato adatta per ambienti interni, ideale per applicazioni a soffitto e parete
- _ Personalizzabile con anello di colore grigio incluso nella confezione
- _ Flusso luminoso uniforme

- _ Round polycarbonate ceiling light suitable for indoor environments, ideal for ceiling and wall applications
- _ Customizable with grey ring included
- _ Uniform luminous flux



W	K	LUMEN APPARECCHIO lm	LUMEN SORGENTE lm	MISURE	VARIANTE	CODICE	EAN		
14	3000	950	1700	120°	1	COCO162	8031453015237	1/5	A T G E
14	4000	950	1700	120°	1	COCO163	8031453015251	1/5	A T G E
17	3000	1200	2000	120°	2	COCO212	8031453015275	1/5	A T G E
17	4000	1200	2000	120°	2	COCO213	8031453025588	1/5	A T G E
24	3000	1700	2800	120°	3	COCO242	8031453025595	1/4	A T G E
24	4000	1700	2800	120°	3	COCO243	8031453025601	1/4	A T G E



LINZ

RIO

Plafoniera / Ceiling light

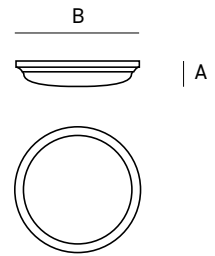

Dimensioni	A	B
1	80	305
2	88	400

_ Plafoniera in policarbonato versatile e di facile installazione (ad esempio per bagni, garage, corridoi, scale, etc.)
_ Disponibile in due dimensioni

_ Versatile, easy-to-install ceiling light with polycarbonate diffuser (e.g. for bathrooms, garages, corridors, stairs, etc.)
_ Available in two sizes



W	K	LUMEN APPARECCHIO lm	MISURE	VARIANTE	CODICE	EAN			
12	3000	1000	150°	1	-	4116137	6435200193445	1/6	
12	4000	1000	150°	1	-	4116170	6435200194237	1/6	
20	3000	1600	150°	2	-	4116164	6435200193452	1/6	

RIO RADAR

Plafoniera con radar / Radar ceiling light

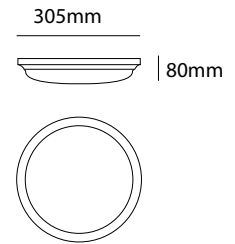

- _ Plafoniera in policarbonato versatile e di facile installazione (ad esempio per bagni, garage, corridoi, scale, etc.)
- _ Versione con sensore di movimento a microonde regolabile: - Luce ambiente: 2-50 lux - disabilitato. Distanza di rilevamento: 2-10m - Tempo di accensione: 5sec - 30min
- _ Altezza di installazione: 2-3m

- _ Versatile, easy-to-install ceiling light with polycarbonate diffuser (e.g. for bathrooms, garages, corridors, stairs, etc.)
- _ Version with adjustable microwave movement sensor: - Ambient light level: 2-50 lux - disabled. Movement detection range: 2-10m - Light-on time: 5sec - 30min
- _ Height of installation: 2-3m



W	K	LUMEN APPARECCHIO lm		VARIANTE	CODICE	EAN			
12	3000	1000	150°	-	4116165	6435200193469	1/6		

ERIKA ROUND

BTL CATEGORIA SCONTO 23

Plafoniera CCT / CCT ceiling light

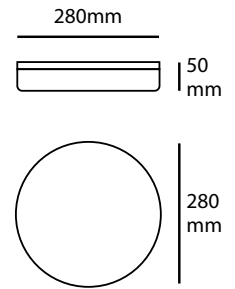

- _ Plafoniera tonda in policarbonato anti UV, IP54, ideale sia per esterni che per interni
- _ Di facile installazione a soffitto o a parete grazie ad una staffa di fissaggio in metallo
- _ CCT selezionabile

- _ Round anti-UV polycarbonate ceiling light , IP54, ideale for both outdoor and indoor use.
- _ Easy to install on the ceiling or wall thanks to a metal fixing bracket
- _ Selectable CCT

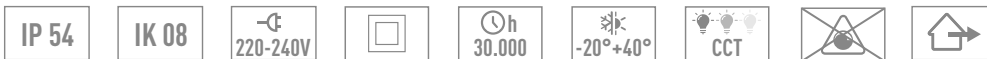

W	K	LUMEN APPARECCHIO lm	LUMEN SORGENTE lm		VARIANTE	CODICE	EAN			
24	<input checked="" type="checkbox"/> 3000 <input type="checkbox"/> 4200 <input type="checkbox"/> 6500	2400	2700	120°	-	ERIKA24R	8031453025755	1/10		

ERIKA SQUARED

BTL CATEGORIA SCONTO 23

Plafoniera CCT / CCT ceiling light

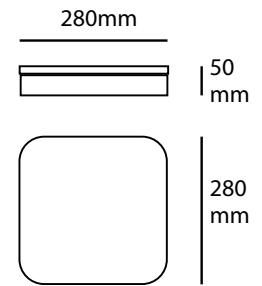

- _ Plafoniera quadrata in policarbonato anti UV , IP54, ideale sia per esterni che per interni
- _ Di facile installazione a soffitto o a parete grazie ad una staffa di fissaggio in metallo
- _ CCT selezionabile

- _ Squared anti-UV polycarbonate ceiling light , IP54, ideal for both outdoor and indoor use.
- _ Easy to install on the ceiling or wall thanks to a metal fixing bracket
- _ Selectable CCT

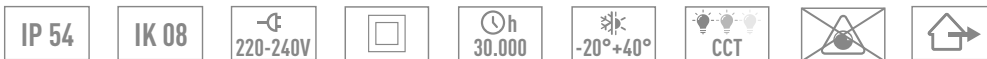

W	K	LUMEN APPARECCHIO lm	LUMEN SORGENTE lm		VARIANTE	CODICE	EAN		
24	<input type="checkbox"/> 3000 <input type="checkbox"/> 4200 <input type="checkbox"/> 6500	2400	2700	120°	-	ERIKA24Q	8031453025762	1/10	

NORA ROUND NEW

BTL CATEGORIA SCONTO 23

Plafoniera CCT / CCT ceiling light

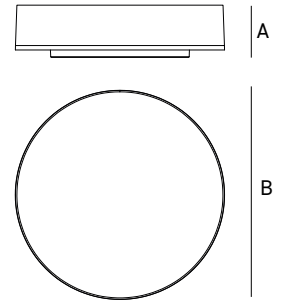

Dimensioni	A	B
1	70	280
2	70	400

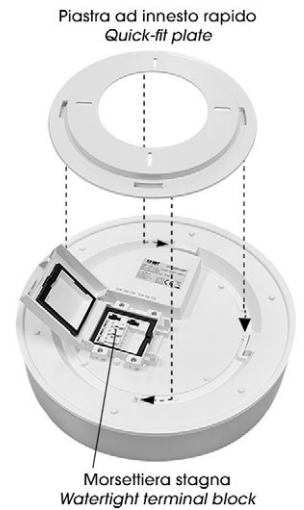

Trasforma l'atmosfera di ogni stanza con l'eleganza minimalista di questa plafoniera il cui design è caratterizzato da linee tese e spigoli vivi.

- _ Plafoniera tonda in policarbonato, IP54, ideale sia per esterni che per interni
- _ Installazione semplificata con base separata e innesto a baionetta
- _ Potenza selezionabile tramite l'apposito selettore
- _ CCT selezionabile

Transform the atmosphere of any room with the minimalist elegance of this ceiling light, characterized by its clean lines and sharp edges.

- _ Round polycarbonate ceiling light, IP54, suitable for both outdoor and indoor use
- _ Simplified installation with separate base and bayonet fitting
- _ Selectable power via dedicated selector
- _ Selectable CCT



W	K	LUMEN APPARECCHIO lm	LUMEN SORGENTE lm	MISURE	VARIANTE	CODICE	EAN		
12	3000	1450	1900	125° 1	-	NORA24RK	8031453032364	1/5	A t G D
18	4000	2150	2850						
24	5000	2900	3800						
24	3000	2900	3800	125° 2	-	NORA36RK	8031453034405	1/5	A t G D
30	4000	3600	4750						
36	5000	4400	5700						



NORA ROUND

NORA SQUARED NEW

BTL CATEGORIA SCONTO 23

Plafoniera CCT / CCT ceiling light

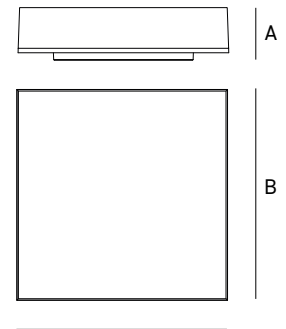

Dimensioni	A	B
1	70	280
2	70	400

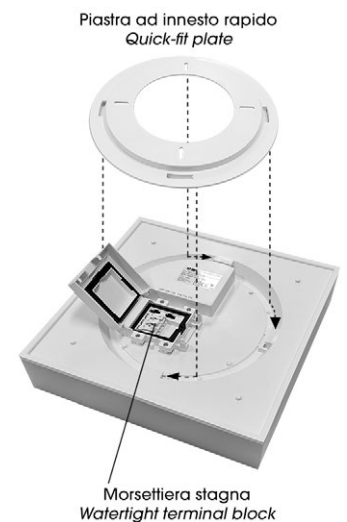

Trasforma l'atmosfera di ogni stanza con l'eleganza minimalista di questa plafoniera il cui design è caratterizzato da linee tese e spigoli vivi.

- _ Plafoniera quadrata in policarbonato, IP54, ideale sia per esterni che per interni
- _ Installazione semplificata con base separate e innesto a baionetta
- _ Potenza selezionabile tramite l'apposito selettore
- _ CCT selezionabile

Transform the atmosphere of any room with the minimalist elegance of this ceiling light, characterized by its clean lines and sharp edges.

- _ Squared polycarbonate ceiling light, IP54, suitable for both outdoor and indoor use
- _ Simplified installation with separate base and bayonet fitting
- _ Selectable power via dedicated selector
- _ Selectable CCT



W	K	LUMEN APPARECCHIO lm	LUMEN SORGENTE lm	MISURE	VARIANTE	CODICE	EAN		
12	3000	1450	1900	125° 1	-	NORA24QK	8031453032371	1/5	A t G D
18	4000	2150	2850						
24	5000	2900	3800						
24	3000	2900	3800	125° 2	-	NORA36QK	8031453034399	1/5	A t G D
30	4000	3600	4750						
36	5000	4400	5700						



NORA SQUARED

SONO III PIR AGGIORNATO

BTL CATEGORIA SCONTO 23

Plafoniera PIR / PIR ceiling light

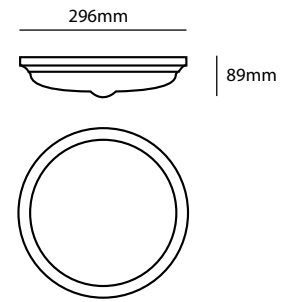

- _ Plafoniera in policarbonato particolarmente indicata per frequenti accensioni e spegnimenti
- _ Sensore di presenza PIR con sistema master/slave.
- _ Pilota fino ad altre due plafoniere SONO III PIR
- _ Regolazioni del sensore: - Tempo di accensione: 15s - 30min - Distanza di rilevamento: 2-6m - Luminosità ambientale: 2-2000lux
- _ Altezza di installazione: 2-3 m

- _ Ceiling light with polycarbonate diffuser particularly recommended for frequent on/off
- _ PIR presence sensor with master/slave system.
- _ Drives up to two more SONO III PIR luminaires
- _ Sensor adjustments: - Light-on time: 15s - 30min - Detection distance: 2-6m - Ambient light level: 2-2000lux
- _ Installation height: 2-3 m



W	K	LUMEN APPARECCHIO lm		VARIANTE	CODICE	EAN	
15	 3500	1500	120°	-	4146957	6435200309181	1/6



SONO

Plafoniera multifunzione ad alta resistenza / High resistance multifunctional ceiling light

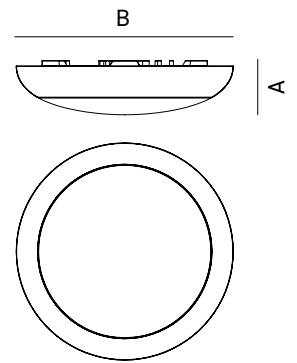

Dimensioni	A	B
1	80	280
2	80	320

- _ Plafoniera tonda in policarbonato anti UV ideale sia per esterno che per interno
- _ Protezione all'umidità IP65 e alta resistenza meccanica IK10
- _ Predisposizione collegamento passante sui lati
- _ Disponibile variante con modulo emergenza 3h di durata a 150lm
- _ Disponibile variante con sensore a microonde programmabile mediante dip-switch (sensibilità, livello di luce ambientale, durata, luce di cortesia)
- _ Potenza e CCT selezionabili
- _ Cornice bianca in dotazione, opzionale cornice in colore nero

- _ Round anti-UV polycarbonate ceiling light suitable for both outdoor and indoor use
- _ IP65 humidity protection and IK10 high mechanical resistance
- _ Predisposition for through connection on sides
- _ Available variant with emergency module lasting 3 hours at 150 lumens
- _ Available variant with microwave sensor programmable via dip-switch (sensitivity, ambient light level, duration, courtesy light)
- _ Power and CCT selectable
- _ White frame included, optional black frame available



W	K	LUMEN APPARECCHIO lm	LUMEN SORGENTE lm	MISURE	VARIANTE	CODICE	EAN	Accessori	Emblemi
					ON/OFF	GIADAI12K	8031453033835	1/4	A ↑ G D
8	3000	950	1100	120°	EMERGENZA / EMERGENCY ¹	GIADAI12KE	8031453033842	1/4	A ↑ G D
10	4000	1200	1400		SENSORE A MICROONDE / MICROWAVE SENSOR ²	GIADAI12KS	8031453033859	1/4	A ↑ G D
12	6500	1500	1700		MICROONDE + EMERGENZA / MICROWAVE SENSOR + EMERGENCY ^{1 2}	GIADAI12KSE	8031453033866	1/4	A ↑ G D
Accessorio GIADA II 280mm Anello decorativo Nero						GIADAI12B	8031453033941	1	
					ON/OFF	GIADAI20K	8031453033873	1/4	A ↑ G D
12	3000	1450	1700	120°	EMERGENZA / EMERGENCY ¹	GIADAI20KE	8031453033880	1/4	A ↑ G D
16	4000	2000	2300		SENSORE A MICROONDE / MICROWAVE SENSOR ²	GIADAI20KS	8031453033897	1/4	A ↑ G D
20	6500	2500	2800		MICROONDE + EMERGENZA / MICROWAVE SENSOR + EMERGENCY ^{1 2}	GIADAI20KSE	8031453033903	1/4	A ↑ G D
Accessorio GIADA II 320mm Anello decorativo Nero						GIADAI20B	8031453033934	1	



GIADA II

Plafoniera / Ceiling light

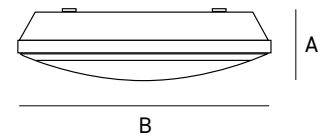

Dimensioni	A	B	C
1	100	300	300
2	118	355	355



Questa plafoniera robusta e di dimensione generosa, illumina ogni ambiente in modo efficiente e pratico. Perfetta per chi cerca qualità e durata.

- _ Plafoniera tonda in policarbonato anti UV ideale sia per esterno che per interno
- _ Protezione all'umidità IP65 e alta resistenza meccanica IK10
- _ Installazione rapida a parete o a soffitto grazie alle clip di fissaggio
- _ Attacco E27 sorgenti LED max 2x20W per SONJAE27x
- _ Attacco E27 sorgenti LED max 3x20W per SONJA3E27B

This sturdy and generously sized ceiling light illuminates any room efficiently and practically. Perfect for those looking for quality and durability.

- _ Round ceiling light in anti-UV PC ideal for both outdoor and indoor use
- _ IP65 humidity protection and IK10 high mechanical resistance
- _ Quick wall or ceiling installation thanks to the fixing clips.
- _ E27 base for LED light sources max 2x20W for SONJAE27x
- _ E27 base for LED light sources max 3x20W for SONJA3E27B



BASE		MISURE	VARIANTE	CODICE	EAN	
E27	-	1	<input type="checkbox"/> BIANCO / WHITE	SONJAE27B	8031453029432	1/6
E27	-	1	<input checked="" type="checkbox"/> NERO / BLACK	SONJAE27N	8031453031428	1/6
NEW E27	-	2	<input type="checkbox"/> BIANCO / WHITE	SONJA3E27B	8031453032548	1/6

SONJA OVAL NEW

BTL CATEGORIA SCONTO 23

Plafoniera / Ceiling light

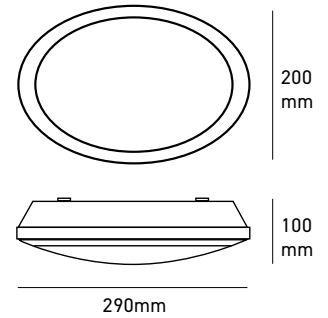



Plafoniera ovale elegante e robusta, perfetta per illuminare ogni ambiente in modo efficace, garantendo durata e versatilità.

- _ Plafoniera ovale in policarbonato anti UV ideale sia per esterno che per interno
- _ Protezione all'umidità IP65 e alta resistenza meccanica IK10
- _ Installazione rapida a parete o a soffitto grazie alle clip di fissaggio
- _ Attacco E27 per sorgenti LED max 20W

Elegant and robust oval ceiling light, perfect for effectively illuminating any room, ensuring durability and versatility.

- _ *Oval ceiling light in anti-UV PC ideal for both outdoor and indoor use*
- _ *IP65 humidity protection and IK10 high mechanical resistance*
- _ *Quick wall or ceiling installation thanks to the fixing clips.*
- _ *E27 base for LED light sources max 20W*



BASE		VARIANTE	CODICE	EAN	
E27	-	<input type="checkbox"/> BIANCO / WHITE	SONJA1E27B	8031453032524	1/12
E27	-	<input checked="" type="checkbox"/> NERO / BLACK	SONJA1E27N	8031453032531	1/12

OVIEDO ROUND

BTL CATEGORIA SCONTO 23

Plafoniera CCT / CCT ceiling light

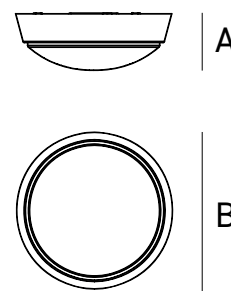

Dimensioni	A	B
1	68	180
2	78	220



Accessori inclusi
Accessories included

- Plafoniera tonda con diffusore in policarbonato ideale sia per esterno che per interno
- Installazione sia a parete che a soffitto
- Disponibile anche in variante con sensore crepuscolare con soglia di intervento sotto i 30lux
- CCT selezionabile
- Anello bianco e nero in dotazione

- Round ceiling light with polycarbonate diffuser, ideal for both outdoor and indoor use
- Wall or ceiling installation
- Available with dusk sensor with intervention below 30lux
- Selectable CCT
- White and black rings included



W	K	LUMEN APPARECCHIO lm	LUMEN SORGENTE lm	MISURE	VARIANTE	CODICE	EAN			
15	3000	1550	2000	120°	1	-	OVIEDO15R	8031453025663	1/20	
	4200									
	6500									
15	3000	1550	2000	120°	1	SENSORE CREPUSCOLARE/ DUSK SENSOR *	OVIEDO15RS	8031453025700	1/20	
	4200									
	6500									
24	3000	2350	2900	120°	2	-	OVIEDO24R	8031453025670	1/20	
	4200									
	6500									

OVIEDO OVAL

Plafoniera CCT / CCT ceiling light

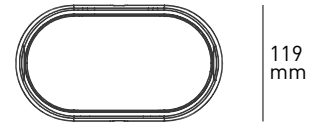
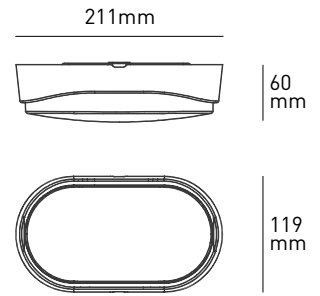

Accessori inclusi
Accessories included

- _ Plafoniera ovale con diffusore in policarbonato ideale sia per esterno che per interno
- _ Installazione sia a parete che a soffitto
- _ Disponibile anche in variante con sensore crepuscolare con soglia di intervento sotto i 30lux
- _ CCT selezionabile
- _ Anello bianco e nero in dotazione

- _ *Oval ceiling light with polycarbonate diffuser, ideal for both outdoor and indoor use*
- _ *Wall or ceiling installation*
- _ *Available with dusk sensor with intervention below 30lux*
- _ *Selectable CCT*
- _ *White and black rings included*

IP 65
IK 08
220-240V
30.000h
-20°+40°
CCT
AUTOMATIC ON-OFF

W	K	LUMEN APPARECCHIO lm	LUMEN SORGENTE lm	Beam angle	VARIANTE	CODICE	EAN	Box	Energy class
15	<input type="checkbox"/> 3000 <input type="checkbox"/> 4200 <input type="checkbox"/> 6500	1550	2000	120°	-	OVIEDO150	8031453025687	1/20	A+G E
15	<input type="checkbox"/> 3000 <input type="checkbox"/> 4200 <input type="checkbox"/> 6500	1550	2000	120°	SENSORE CREPUSCOLARE/ DUSK SENSOR *	OVIEDO150S	8031453025717	1/20	A+G E
18	<input type="checkbox"/> 3000 <input type="checkbox"/> 4200 <input type="checkbox"/> 6500	1750	2350	120°	-	OVIEDO180	8031453025694	1/20	A+G E





Plafoniera CCT / CCT ceiling light

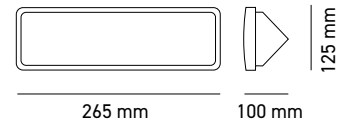

Plafoniera per esterni a led integrato ad alta emissione caratterizzata da luce diffusa a 45°.

Outdoor ceiling light with integrated high-output LED, featuring 45° diffused lighting.

- _ Plafoniera in policarbonato, protezione IP65, ideale sia per esterno che per interno
- _ Di facile installazione
- _ CCT selezionabile

- _ Polycarbonate ceiling light, IP65, ideal for both outdoor and indoor use
- _ Easy to install
- _ Selectable CCT

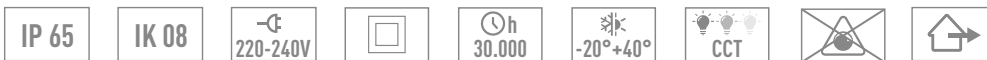

W	K	LUMEN APPARECCHIO lm	LUMEN SORGENTE lm		VARIANTE	CODICE	EAN		
12	<input type="checkbox"/> 3000 <input type="checkbox"/> 4000 <input type="checkbox"/> 6000	1320	1900	120°	<input type="checkbox"/> BIANCO / WHITE	BURGOS12BK	8031453032555	1/32	
12	<input type="checkbox"/> 3000 <input type="checkbox"/> 4000 <input type="checkbox"/> 6000	1320	1900	120°	<input checked="" type="checkbox"/> NERO / BLACK	BURGOS12NK	8031453032562	1/32	



BURGOS





SHOT
BOT LIGHTING

TECNICO / PANNELLI LED
TECHNICAL / LED PANELS



PANNELLO LED BACKLIT 600X600 ALTA EFFICIENZA

600X600 HIGH EFFICIENCY BACKLIT LED PANEL

BTL CATEGORIA
SCONTO 23

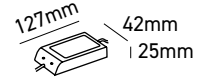
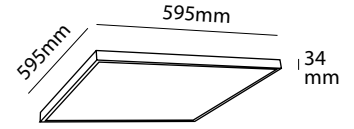
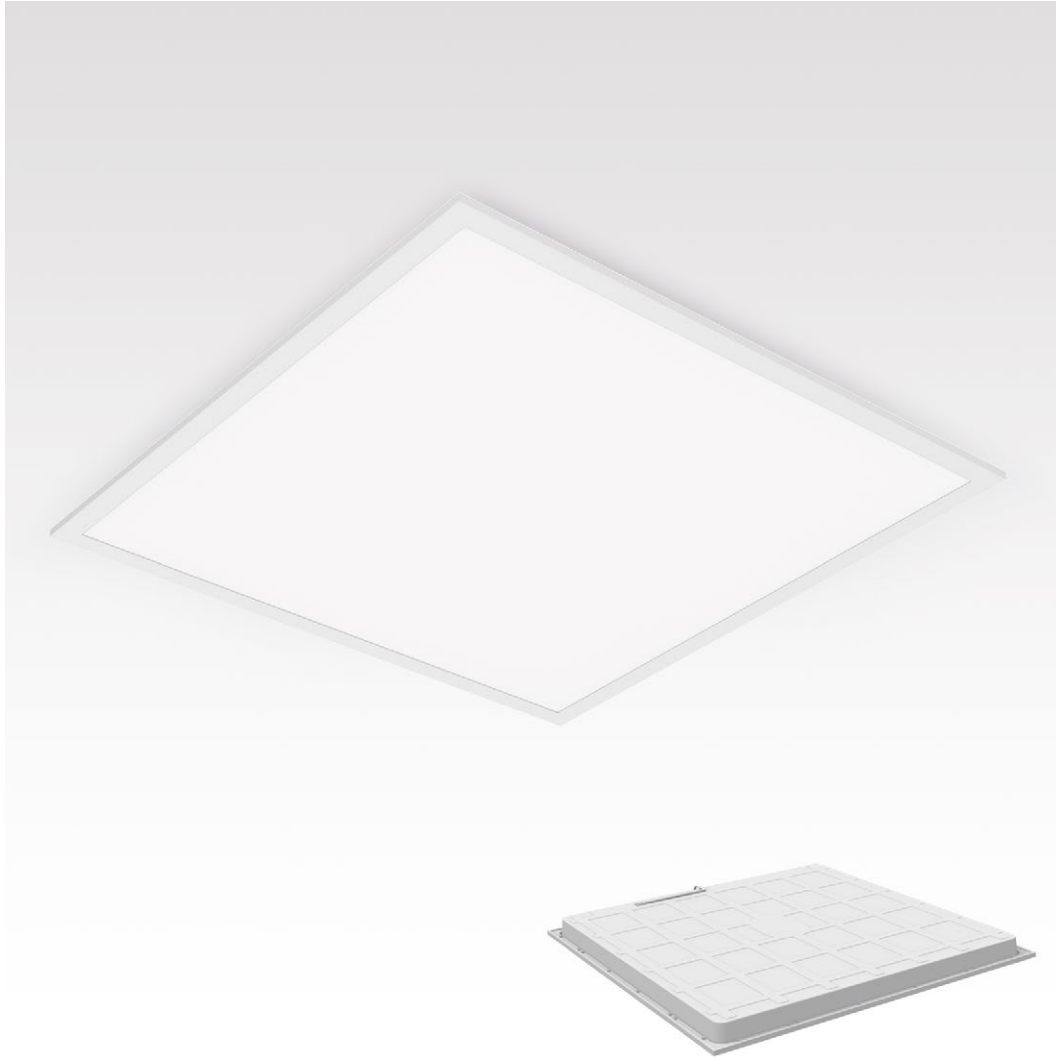

Driver compreso nella confezione
Driver included

- _ Pannello LED retroilluminato, non necessita di LGP
- _ Alta efficienza 140lm/W
- _ Protezione frontale IP40, posteriore IP20
- _ Cornice in alluminio verniciato bianco RAL9016
- _ In opzione driver dimmerabile DALI-Push
- _ In opzione kit di emergenza con connettore DC
- _ In opzione kit di montaggio a plafone, sospensione ed incasso

- _ Backlit LED panel, LGP not required
- _ 140lm/W high efficiency
- _ IP40 front / IP20 rear protection
- _ RAL9016 white painted finish aluminium frame
- _ Optional: DALI-Push dimmable driver
- _ Optional: emergency kit with DC connector
- _ Optional: surface mounting, suspension or recessed KIT



* **UGR <19**

W	K	LUMEN APPARECCHIO lm	LUMEN SORGENTE lm		VARIANTE	CODICE	EAN		
25	<input type="checkbox"/> 4000	3500	4000	120°	-	LD4PAN2553H	8031453027759	1/4	
25	<input type="checkbox"/> 4000	3500	4000	90°	UGR<19 *	LD4PAN2553HU	8031453027766	1/4	

PANNELLO LED BACKLIT 600X600 ALTA EMISSIONE

600X600 HIGH EMISSION BACKLIT LED PANEL

BTL CATEGORIA
SCONTO 23

NEW

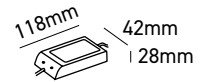
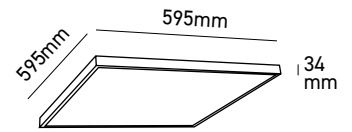
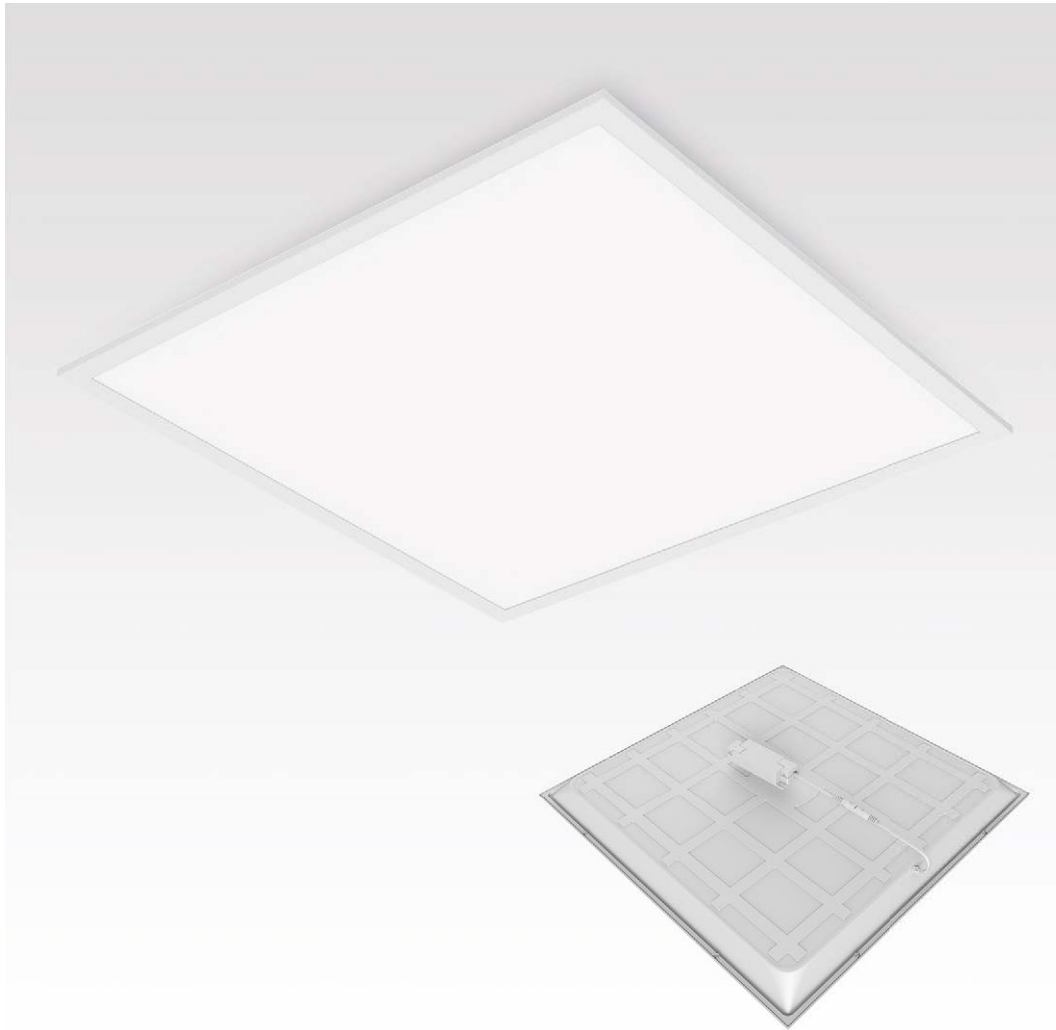

Driver compreso nella confezione
Driver included

- _ Pannello LED retroilluminato, non necessita di LGP
- _ Alta efficienza 170lm/W
- _ Protezione frontale IP40, posteriore IP20
- _ Driver Philips a lunga durata: 50.000h
- _ Cornice in alluminio verniciato bianco RAL9016
- _ In opzione kit di emergenza con connettore DC
- _ In opzione kit di montaggio a plafone, sospensione ed incasso

- _ Backlit LED panel, LGP not required
- _ 170lm/W high efficiency
- _ IP40 front / IP20 rear protection
- _ 50.000h long lifespan Philips driver
- _ RAL9016 white painted finish aluminium frame
- _ Optional: emergency kit with DC connector
- _ Optional: surface mounting, suspension or recessed KIT



W	K	LUMEN APPARECCHIO lm	LUMEN SORGENTE lm		VARIANTE	CODICE	EAN			
36	<input type="checkbox"/>	4000	5000	6250	110°	-	LD4PAN5053	8031453034276	1/4	
36	<input type="checkbox"/>	4000	5000	6500	90°	UGR<19 ²	LD4PAN5053U	8031453034283	1/4	
36	<input type="checkbox"/>	4000	5000	6250	110°	DALI/PUSH ¹	LD4PAN5053D	8031453034474	1/4	
36	<input type="checkbox"/>	4000	5000	6500	90°	UGR<19 - DALI/PUSH ^{1 2}	LD4PAN5053UD	8031453034481	1/4	

PANNELLO LED BACKLIT 600X600

600X600 BACKLIT LED PANEL

NEW

BTL CATEGORIA
SCONTO 23

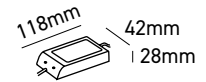
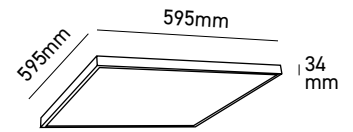
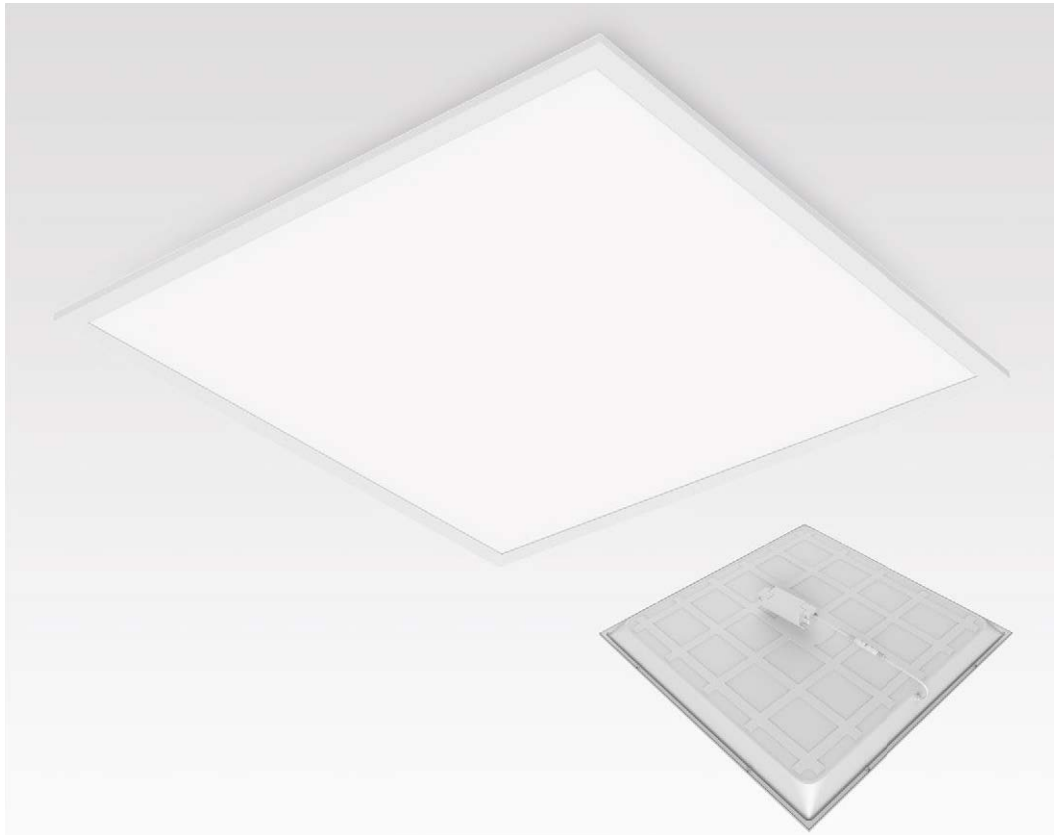

Driver compreso nella confezione
Driver included

- _ Pannello LED retroilluminato, non necessita di LGP
- _ Protezione frontale IP40, posteriore IP20
- _ Driver Philips a lunga durata: 50.000h
- _ Cornice in alluminio verniciato bianco RAL9016
- _ In opzione kit di emergenza con connettore DC
- _ In opzione kit di montaggio a plafone, sospensione ed incasso

- _ Backlit LED panel, LGP not required
- _ IP40 front / IP20 rear protection
- _ 50.000h long lifespan Philips driver
- _ RAL9016 white painted finish aluminium frame
- _ Optional: emergency kit with DC connector
- _ Optional: surface mounting, suspension or recessed KIT



W	K	LUMEN APPARECCHIO lm	LUMEN SORGENTE lm		VARIANTE	CODICE	EAN			
36		3000	3600	4300	110°	-	LD4PAN3652-2	8031453033330	1/4	
36		4000	3600	4500	110°	-	LD4PAN3653-2	8031453033347	1/4	
36		4000	3600	4500	90°	UGR<19 ³	LD4PAN3653U-2	8031453033354	1/4	
36		4000	3600	4500	90°	CRI>90 - UGR<19 ^{2 3}	LD4PAN3653U9-2	8031453034290	1/4	
36		3000	3600	4300	110°	DALI/PUSH ¹	LD4PAN3652-2D	8031453034238	1/4	
36		4000	3600	4500	110°	DALI/PUSH ¹	LD4PAN3653-2D	8031453034245	1/4	
36		4000	3600	4500	90°	UGR<19 - DALI/PUSH ^{1 3}	LD4PAN3653U-2D	8031453034252	1/4	
36		4000	3600	4500	90°	CRI>90 - UGR<19 - DALI/PUSH ^{1 2 3}	LD4PAN3653U9-2D	8031453034443	1/4	

PANNELLO LED BACKLIT 600X600 - VALUE 4PACK

BTL CATEGORIA
SCONTO 23

600X600 BACKLIT LED PANEL - VALUE 4PACK

NEW

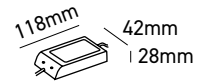
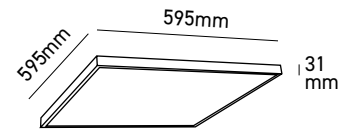

Driver compreso nella confezione
Driver included



- _ Pannello LED retroilluminato, non necessita di LGP
- _ Protezione frontale IP40, posteriore IP20
- _ Cornice in alluminio verniciato bianco RAL9016
- _ In opzione driver dimmerabile DALI-Push
- _ In opzione kit di emergenza con connettore DC
- _ In opzione kit di montaggio a plafone, sospensione ed incasso
- _ Confezione da 4 pannelli (1 pezzo corrisponde a 4 pannelli)

- _ Backlit LED panel, LGP not required
- _ IP40 front / IP20 rear protection
- _ RAL9016 white painted finish aluminium frame
- _ Optional: DALI-Push dimmable driver
- _ Optional: emergency kit with DC connector
- _ Optional: surface mounting, suspension or recessed KIT
- _ Pack of 4 panels (1 piece corresponds to 4 panels)



* UGR <19

W	K	LUMEN APPARECCHIO lm	LUMEN SORGENTE lm		VARIANTE	CODICE	EAN			
36		3000	3600	3800	120°	-	LD4PAN3652V-2	8031453033309	1 (4pz)	
36		4000	3600	4100	120°	-	LD4PAN3653V-2	8031453033316	1 (4pz)	
36		4000	3600	4300	90°	UGR<19 *	LD4PAN3653VU-2	8031453033323	1 (4pz)	

PANNELLO LED BACKLIT 300X1200

300X1200 BACKLIT LED PANEL

NEW

BTL CATEGORIA
SCONTO 23

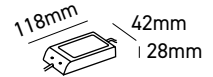
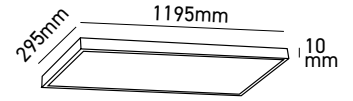

Driver compreso nella confezione
Driver included

- _ Pannello LED retroilluminato, non necessita di LGP
- _ Protezione frontale IP40, posteriore IP20
- _ Driver Philips a lunga durata: 50.000h
- _ Cornice in alluminio verniciato bianco RAL9016
- _ In opzione kit di emergenza con connettore DC
- _ In opzione kit di montaggio a plafone, sospensione ed incasso

- _ Backlit LED panel, LGP not required
- _ IP40 front / IP20 rear protection
- _ 50.000h long lifespan Philips driver
- _ RAL9016 white painted finish aluminium frame
- _ Optional: emergency kit with DC connector
- _ Optional: surface mounting, suspension or recessed KIT



W	K	LUMEN APPARECCHIO lm	LUMEN SORGENTE lm		VARIANTE	CODICE	EAN		
36	4000	3600	4300	110°	-	LD4PAN3653B-2	8031453034429	1/4	
36	4000	3600	4500	90°	CRI>90 - UGR<19 ^{2 3}	LD4PAN3653UB9-2	8031453034306	1/4	
36	4000	3600	4300	110°	DALI/PUSH ¹	LD4PAN3653B-2D	8031453034450	1/4	
36	4000	3600	4500	90°	CRI>90 - UGR<19 - DALI/PUSH ^{1 2 3}	LD4PAN3653UB9-2D	8031453034467	1/4	

PANNELLO LED EDGELIT 600X600

600X600 EDGELIT LED PANEL

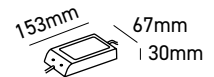
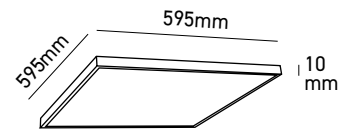
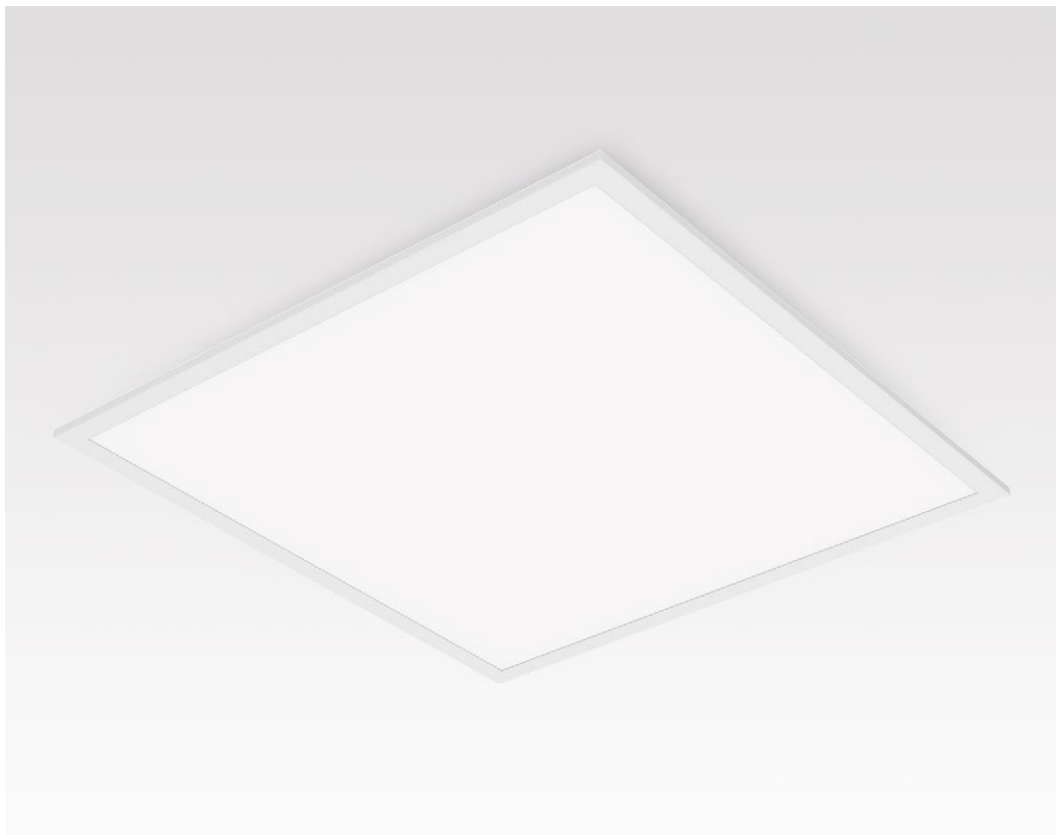

Driver compreso nella confezione
Driver included

- _ Pannello LED spessore 10mm ad illuminazione laterale
- _ LGP in PMMA anti ingiallimento per la versione 45W
- _ Protezione frontale IP40, posteriore IP20
- _ Cornice in alluminio verniciato bianco RAL9016
- _ In opzione driver dimmerabile DALI-Push
- _ In opzione kit di emergenza con connettore DC
- _ In opzione kit di montaggio a plafone, sospensione ed incasso

- _ 10mm-thick LED panel with side lighting
- _ Anti-yellowing PMMA LGP for the 45W version
- _ IP40 front / IP20 rear protection
- _ RAL9016 white painted finish aluminium frame
- _ Optional: DALI-Push dimmable driver
- _ Optional: emergency kit with DC connector
- _ Optional: surface mounting, suspension or recessed KIT

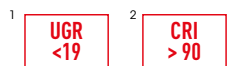

W	K	LUMEN APPARECCHIO lm	LUMEN SORGENTE lm		VARIANTE	CODICE	EAN			
38		3000	3800	5000	110°	-	LD3PAN3852	8031453021740	1/6	
38		4000	3800	5000	110°	-	LD3PAN3853	8031453021757	1/6	
38		6500	3800	5000	110°	-	LD3PAN3851	8031453024697	1/6	
38		4000	3800	5000	90°	UGR<19 ¹	LD3PAN3853U	8031453021771	1/6	
38		3000	3200	4600	90°	CRI>90 - UGR<19 ^{1 2}	LD3PAN3852U9	8031453022952	1/6	
38		4000	3400	4900	90°	CRI>90 - UGR<19 ^{1 2}	LD3PAN3853U9	8031453022969	1/6	
45		3000	5000	6800	90°	UGR<19 ¹	LD3PAN4552U	8031453022631	1/6	
45		4000	5000	6900	90°	UGR<19 ¹	LD3PAN4553U	8031453022648	1/6	

PANNELLO LED EDGELIT 300X1200

300X1200 EDGELIT LED PANEL

BTL CATEGORIA
SCONTO 23

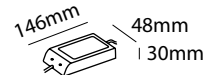
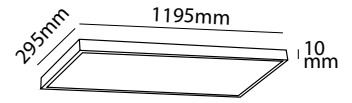

Driver compreso nella confezione
Driver included

- _ Pannello LED spessore 10mm ad illuminazione laterale
- _ Protezione frontale IP40, posteriore IP20
- _ Cornice in alluminio verniciato bianco RAL9016
- _ In opzione driver dimmerabile DALI-Push
- _ In opzione kit di emergenza con connettore DC
- _ In opzione kit di montaggio a plafone, sospensione ed incasso

- _ 10mm-thick LED panel with side lighting
- _ IP40 front / IP20 rear protection
- _ RAL9016 white painted finish aluminium frame
- _ Optional: DALI-Push dimmable driver
- _ Optional: emergency kit with DC connector
- _ Optional: surface mounting, suspension or recessed KIT



W	K	LUMEN APPARECCHIO lm	LUMEN SORGENTE lm		VARIANTE	CODICE	EAN		
38	<input type="checkbox"/> 4000	3800	5000	110°	-	LD3PAN3853B	8031453021764	1/6	
40	<input type="checkbox"/> 4000	3400	4900	90°	CRI>90 - UGR<19 *	LD3PAN3853UB9	8031453025045	1/6	



LED DRIVER CORRENTE COSTANTE PER LED PANEL
 CONSTANT CURRENT LED DRIVER FOR LED PANEL

Dimensioni DRIVER	A	B	C
1	146	48	30
2	153	57	30
3	136	63	31
4	118	42	28

POTENZA Watt		MISURE mm	VARIANTE	CODICE	EAN	IMBALLO
38		1	-	LD3PAND38	8031453022792	1/10
40		1	-	LD3PAND40	8031453025274	1/10
45		2	-	LD3PAND45	8031453022785	1/10
42 MAX	DIMMABLE	3	1-10V	LD3PAND42D	8031453021801	1/10
36		4	-	LD4PAND36-2	8031453033293	1/10

BTL CATEGORIA SCONTO 23

BTL CATEGORIA SCONTO 23

KIT MONTAGGIO A SOSPENSIONE
 SUSPENDED MOUNTING KIT

CODICE	EAN	IMBALLO
LD3PANCAB	8031453021795	1

Cavo lungo / cable length: 800 mm

KIT CAVO SICUREZZA PER LED BACKLIT PANEL
 SAFETY CABLE KIT FOR LED BACKLIT PANEL

CODICE	EAN	IMBALLO
LD4PANSAFE	8031453027360	1



CODICE	EAN	IMBALLO
LD4PANCAB	8031453022563	1

Cavo lungo / cable length: 1500 mm

BTL CATEGORIA SCONTO 23

BTL CATEGORIA SCONTO 23

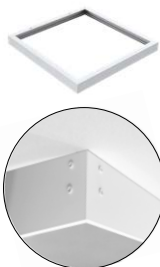
KIT UNIVERSALE MONTAGGIO A PLAFONE
ASSEMBLAGGIO CON VITI
 UNIVERSAL CEILING MOUNTING KIT
 ASSEMBLY WITH SCREWS

CODICE	MISURE mm	EAN	IMBALLO
LD2PANFRM-2	600x600x55	8031453017682	1
LD2PANFRM-2B	300x1200x55	8031453017705	1

KIT UNIVERSALE MONTAGGIO A PLAFONE
ASSEMBLAGGIO AD INCASTRO
 UNIVERSAL CEILING MOUNTING KIT
 INTERLOCKING ASSEMBLY

CODICE	MISURE mm	EAN	IMBALLO
LD4PANFRM	600x600x43	8031453022570	1
LD4PANFRMH	600x600x67	8031453027353	1
LD4PANFRMB	300x1200x43	8031453022587	1
LD4PANFRMHB	300x1200x67	8031453034436	1

BTL CATEGORIA SCONTO 23

BTL CATEGORIA SCONTO 23

KIT MONTAGGIO AD INCASSO CON MOLLE
 RECESS MOUNTING KIT WITH SPRINGS



CODICE	EAN	IMBALLO
LD3PANSPG	8031453021818	1

KIT UNIVERSALE MONTAGGIO AD INCASSO
CON CORNICE
 UNIVERSAL RECESSED MOUNTING KIT WITH
 FRAME

CODICE	MISURE mm	EAN	IMBALLO
LD3PANINK	600x600	8031453022921	1
LD3PANINKB	300x1200	8031453022938	1

	LD3PAN3851 LD3PAN3852 LD3PAN3853 LD3PAN3853U LD3PAN3852U9 LD3PAN3853U9	LD3PAN3853B	LD3PAN3853UB9	LD3PAN4552U LD3PAN4553U	LD4PAN2553H LD4PAN2553HU	LD4PAN3652-2 / D LD4PAN3653-2 / D LD4PAN3653U-2 / D LD4PAN3652V-2 / D LD4PAN3653V-2 / D LD4PAN3653VU-2 / D LD4PAN3653U9-2 / D	LD4PAN3653B-2 / D LD4PAN3653UB9-2 / D	LD4PAN5053 / D LD4PAN5053U / D
DRIVERS RICAMBIO	LD3PAND38	X	X					
	LD3PAND40			X				
	LD3PAND45				X			
	LD4PAND36-2					X	X	X
DRIVERS DIM	LD3PAND42D	X	X	X	X			
	MFD-600-42-D					X		
	MFD-1050-42-D	X	X	X	X		X	X
KIT EM	EMK5-90-15-A	X	X	X	X	X	X	X
KIT SOSPENSIONE	LD3PANCAB	X	X	X	X			
	LD4PANCAB					X	X	X
KIT PLAFONE	LD2PANFRM-2	X			X			
	LD2PANFRM-2B		X	X				
	LD4PANFRM	X			X			
	LD4PANFRMB		X	X				
	LD4PANFRMH	X			X	X	X	
	LD4PANFRMHB		X	X				X
KIT INCASSO	LD3PANSPG	X	X	X	X			
	LD3PANINK	X			X	X		X
	LD3PANINKB		X	X			X	

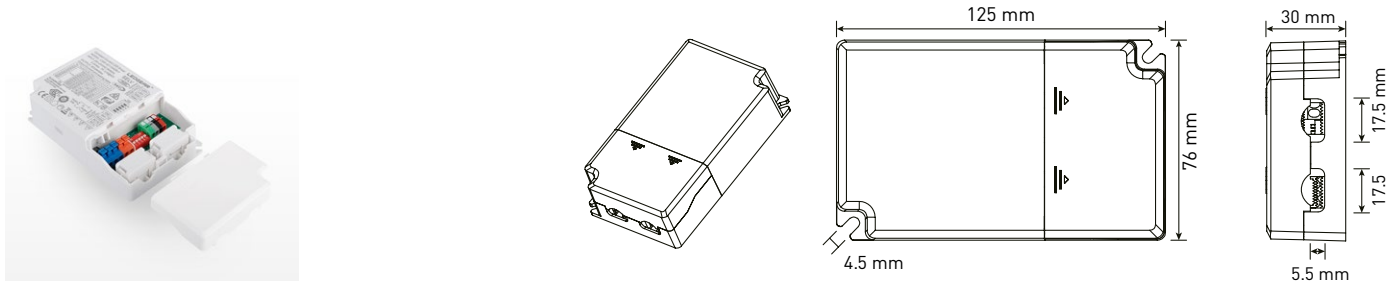
DRIVER DALI/PUSH/0-10V MULTIFUNZIONE / MULTIFUNCTION



- _ DRIVER a corrente costante utilizzabile con apparecchi LED dotati di alimentatore esterno (es LED panel o Downlights)
- _ DRIVER Multifunzione: DALI 2 (IEC 62386-101-102-207), PUSH DIM, 0-10V, 10V PWM
- _ Flicker-free < 3%
- _ Corrente di output selezionabile mediante dip-switch
- _ Marchio ENEC
- _ Isolamento Classe II, SELV secondo EN 61347
- _ Tensione in uscita 14-42V
- _ Vita nominale 50.000 ore
- _ Range di dimmerazione:
 - DALI 1%-100%
 - Push-DIM 2%-100%
 - 0-10V: 10%-100%
- _ Fattore di potenza > 0.95 a piena potenza

- _ Constant current DRIVER usable with LED luminaires equipped with external power supply (e.g. LED panel or Downlights)
- _ Multifunction DRIVER: DALI 2 control (IEC 62386-101-102-207), PUSH DIM, 0-10V, 10V PWM
- _ Flicker percentage <3%
- _ Output current selectable via dip-switch
- _ ENEC brand
- _ Class II insulation, SELV according to EN 61347
- _ Output voltage 14-42V
- _ Rated lifetime 50,000 hours
- _ Dimming range:
 - DALI 1% -100%
 - Push-DIM 2% -100%
 - 0-10V: 10% -100%
- _ Power factor > 0.95 at full power

POTENZA Watt	VARIANTE	CODICE	EAN	IMBALLO
25 max	Dimmable Driver DALI/Push. 250-600mA, 14-42V	MFD-600-42-D	8031453023003	1/10

DALI SETTINGS

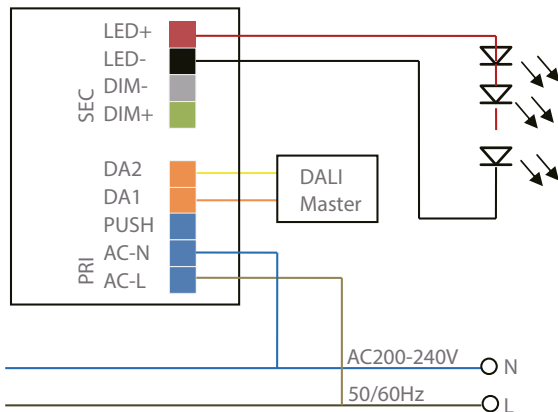

0-10V / 10V PWM

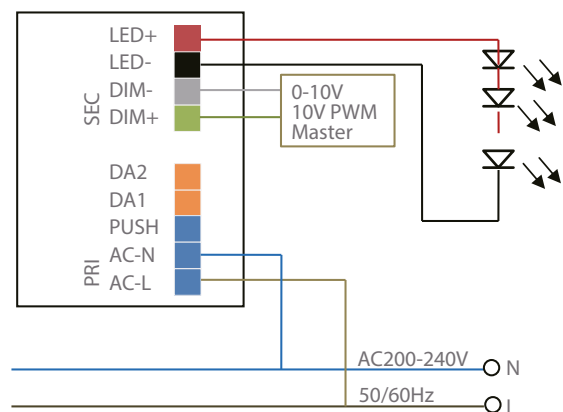

PUSH

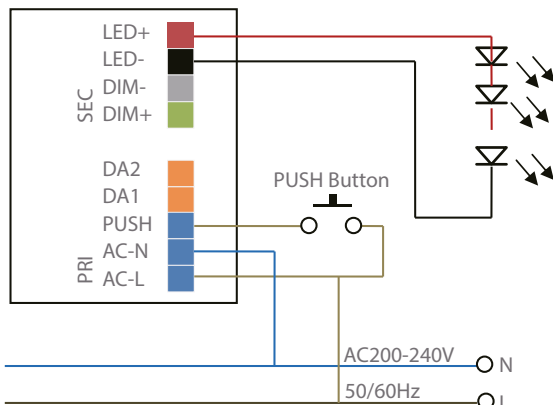

Vo DC	Io DC	Pout	1	2	3
14-42V	250mA	10.5W	OFF	OFF	OFF
	300mA	12.6W	ON	OFF	OFF
	350mA	14.7W	OFF	ON	OFF
	400mA	16.8W	ON	ON	OFF
	450mA	18.9W	OFF	OFF	ON
	500mA	21.0W	ON	OFF	ON
	550mA	23.1W	OFF	ON	ON
	600mA	25.2W	ON	ON	ON

DRIVER DALI / PUSH

MULTIFUNZIONE / MULTIFUNCTION

NEW

BTL CATEGORIA SCONTO 23

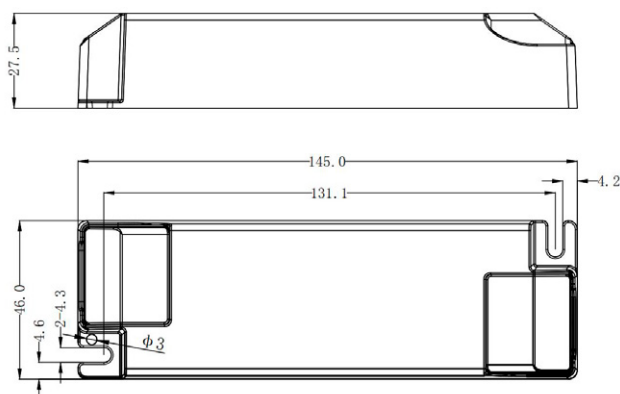

- Driver a corrente costante utilizzabile con apparecchi LED dotati di alimentatore esterno (es LED panel o Downlights)
- Driver multifunzione: DALI 2.0 (IEC 62386-101-102-207), PUSH DIM
- Flicker-free
- Corrente di output selezionabile mediante dip-switch
- Tensione in uscita 9-42V
- Isolamento Classe II, SELV secondo EN 61347
- Vita nominale 50.000 ore
- Range di dimmerazione:
 - DALI 1%-100%
 - Push-DIM 1%-100%
- Fattore di potenza > 0.97 a piena potenza

- Constant current driver suitable with external power supply LED luminaires (e.g. LED panel or Downlights)
- Multifunction driver: DALI 2.0 control (IEC 62386-101-102-207), PUSH DIM
- Flicker free
- Output current selectable via dip-switch
- Output voltage 9-42V
- Class II insulation, SELV according to EN 61347
- Rated lifetime 50,000 hours
- Dimming range:
 - DALI 1% -100%
 - Push-DIM 1% -100%
- Power factor > 0.97 at full power

POTENZA Watt	VARIANTE	CODICE	EAN	IMBALLO
42 max	Dimmable Driver DALI/Push. 700-1050mA, 9-42V	MFD-1050-42-D	8031453034665	1/10

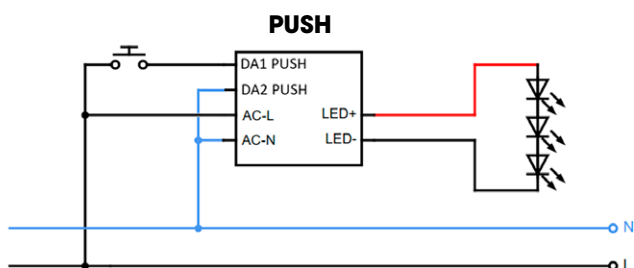
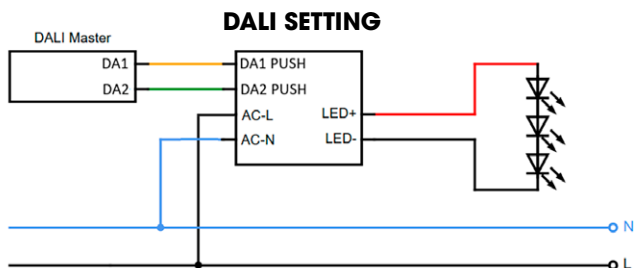

Vo DC	Io DC	Pout	1	2	3
9-42V	700mA	29,4W	ON	ON	ON
	750mA	31,5W	ON	ON	OFF
	800mA	33,6W	ON	OFF	ON
	850mA	35,7W	ON	OFF	OFF
	900mA	37,8W	OFF	ON	ON
	950mA	39,9W	OFF	ON	OFF
9-40V	1050mA	42W	OFF	OFF	ON

KIT EMERGENZA MULTIFUNZIONE MULTIFUNCTIONAL EMERGENCY KIT

BTL CATEGORIA SCONTO 23

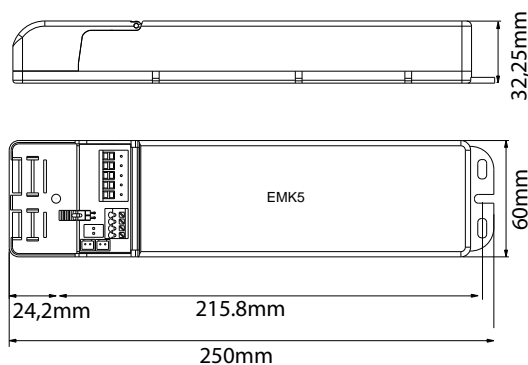

- _ Uscita DC a potenza costante selezionabile dall'utente tramite dip-switch
- _ Corrente in uscita regolata automaticamente
- _ Voltaggio in uscita 10-90V
- _ Durata 3h con potenza 2,5W e 1,5h con potenza 5,0W
- _ Batteria integrata LiFePO 6,4V 1500mAh
- _ Fornito con connettori DC per veloce installazione su pannelli LED ed altri dispositivi che ne sono dotati

- _ DC outlet with constant power selectable by the user through DIP switch
- _ Automatically adjusted output current
- _ Output voltage 10-90V
- _ Duration 3h with 2.5W power output and 1.5h with 5.0W power output
- _ Built-in battery LiFePO 6.4V 1500mAh
- _ Supplied with DC connectors for quick installation on LED panels and other devices fitted with them.

POTENZA Watt	VARIANTE	CODICE	EAN	IMBALLO
-	DIMMABLE	EMK5-90-15-A	8031453021832	1/40

COLLEGAMENTO PER CORRENTE DEL DRIVER <4,0A
 CONNECTION FOR DRIVER CURRENT <4.0A

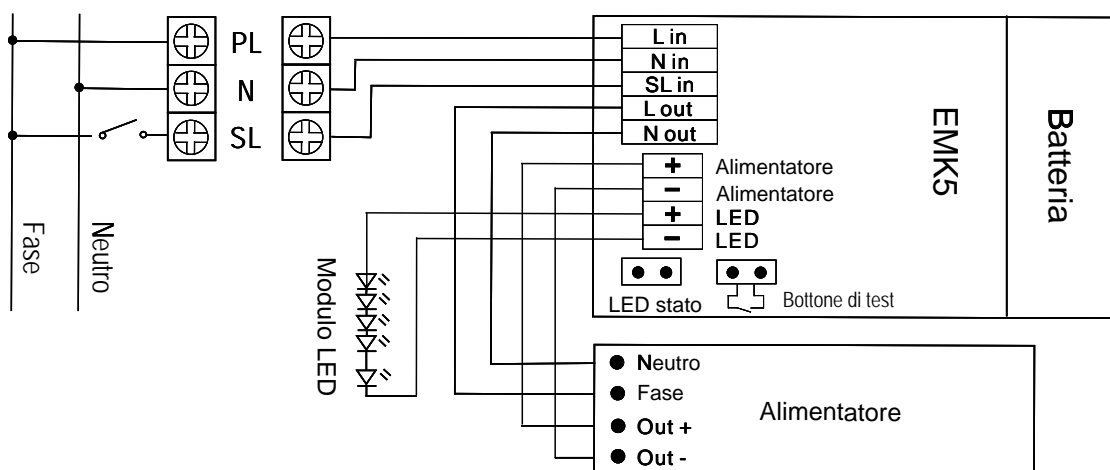

COLLEGAMENTO PER CORRENTE DEL DRIVER >4,0A
 CONNECTION FOR DRIVER CURRENT > 4.0A

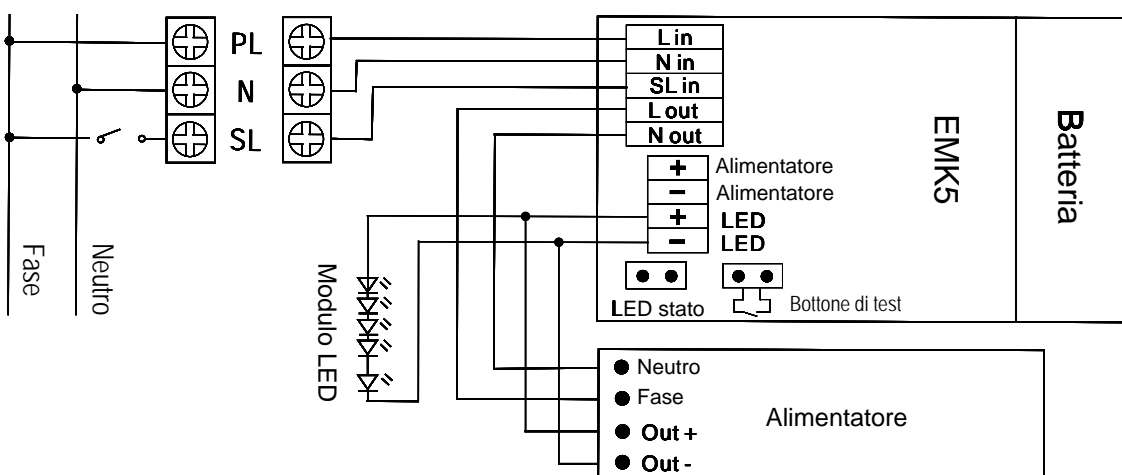





SHOT
BOT LIGHTING

TECNICO DOWNLIGHT /
TECHNICAL DOWNLIGHT



DOWNLIGHT OSLO ROUND

BTL CATEGORIA SCONTO 23

Con cornice intercambiabile / With interchangeable frame

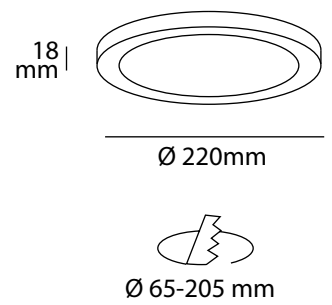

Regolabile
Adjustable

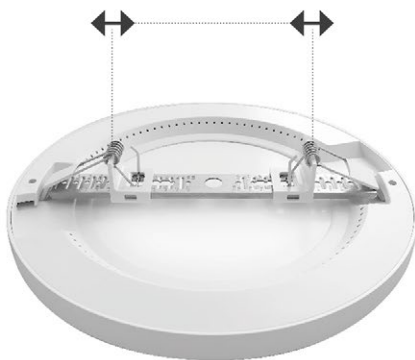

- _ Pannello ad illuminazione laterale con driver integrato nella cornice, spessore totale 18mm
- _ Cornice bianca in dotazione, opzionale cornice in colore argento, nero, oro rosa
- _ Montaggio a superficie diretto, o con staffa a sgancio rapido
- _ Montaggio ad incasso con staffa regolabile per foro Ø65-205mm
- _ CCT selezionabile

- _ Panel with side light source and driver incorporated in the frame, total thickness 18mm
- _ Supplied with white frame, optional frame in silver, black, pink gold colour
- _ Direct surface mounted or with quick release mounting bracket
- _ Recessed with adjustable mounting bracket for Ø65-205mm hole
- _ Selectable CCT



W	K	LUMEN APPARECCHIO lm	LUMEN SORGENTE lm	△	VARIANTE	CODICE	EAN	📦	🌱
18	<input type="checkbox"/> 3000 <input checked="" type="checkbox"/> 4000 <input type="checkbox"/> 5700	1600	2200	110°	-	OSLO185XC	8031453022334	1/20	A+G E

ACCESSORI / ACCESSORIES

<input type="checkbox"/> ARGENTO / SILVER	OSLO01A	8031453022273	1	-
<input type="checkbox"/> NERO / BLACK	OSLO01N	8031453022280	1	-
<input type="checkbox"/> ORO ROSA / PINKGOLD	OSLO01R	8031453022297	1	-

DOWNLIGHT BIG OSLO ROUND

BTL CATEGORIA SCONTO 23

Con cornice intercambiabile / With interchangeable frame

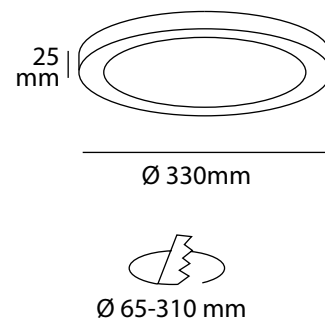

- Pannello ad illuminazione laterale con driver integrato nella cornice, spessore totale 25mm
- Cornice bianca in dotazione, opzionale cornice in colore argento, nero, oro rosa
- Montaggio a superficie diretto, o con staffa a sgancio rapido
- Montaggio ad incasso con staffa regolabile per foro Ø65-310mm
- CCT selezionabile

- Panel with side light source and driver incorporated in the frame, total thickness 25mm
- Supplied with white frame, optional frame in silver, black, pink gold colour
- Direct surface mounted or with quick release mounting bracket
- Recessed with adjustable mounting bracket for Ø65-310mm hole
- Selectable CCT



W	K	LUMEN APPARECCHIO lm	LUMEN SORGENTE lm		VARIANTE	CODICE	EAN		
28	<input type="checkbox"/> 3000 <input type="checkbox"/> 4000 <input type="checkbox"/> 5700	2500	3200	110°	-	OSLO285XC	8031453025236	1/10	

ACCESSORI / ACCESSORIES					VARIANTE	CODICE	EAN		
					ARGENTO / SILVER	OSLO11A	8031453025243	1	-
					NERO / BLACK	OSLO11N	8031453025250	1	-
					ORO ROSA / PINKGOLD	OSLO11R	8031453025267	1	-

DOWNLIGHT OSLO SQUARED

BTL CATEGORIA SCONTO 23

Con cornice intercambiabile / With interchangeable frame

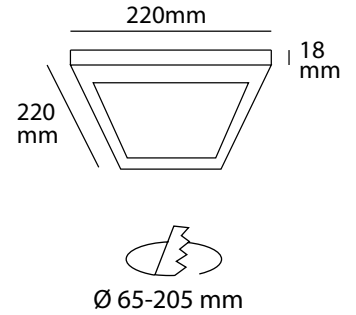

Regolabile
Adjustable

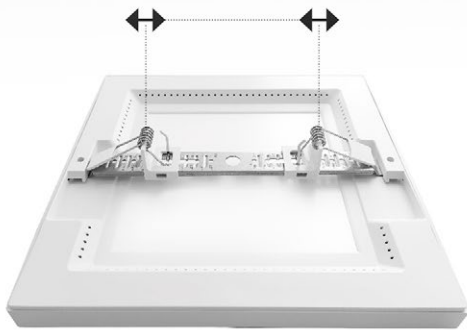

- _ Pannello ad illuminazione laterale con driver integrato nella cornice, spessore totale 18mm
- _ Cornice bianca in dotazione, opzionale cornice in colore argento, nero, oro rosa
- _ Montaggio a superficie diretto, o con staffa a sgancio rapido
- _ Montaggio ad incasso con staffa regolabile per foro Ø65-205mm
- _ CCT selezionabile

- _ Panel with side light source and driver incorporated in the frame, total thickness 18mm
- _ Supplied with white frame, optional frame in silver, black, pink gold colour
- _ Direct surface mounted or with quick release mounting bracket
- _ Recessed with adjustable mounting bracket for Ø65-205mm hole
- _ Selectable CCT



W	K	LUMEN APPARECCHIO lm	LUMEN SORGENTE lm		VARIANTE	CODICE	EAN		
18	<input type="checkbox"/> 3000 <input type="checkbox"/> 4000 <input type="checkbox"/> 5700	1600	2200	110°	-	OSLO185XQ	8031453022341	1/20	
ACCESSORI / ACCESSORIES					<input type="checkbox"/> ARGENTO / SILVER	OSLO02A	8031453022303	1	-
					<input type="checkbox"/> NERO / BLACK	OSLO02N	8031453022310	1	-
					<input type="checkbox"/> ORO ROSA / PINKGOLD	OSLO02R	8031453022327	1	-



OSLO

DOWNLIGHT BODO CCT

BTL CATEGORIA SCONTO 23

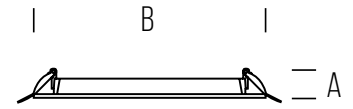

Dimensioni	A	B	Ø
1	36	90	Ø 75
2	46	115	Ø 100
3	48	165	Ø 150
4	50	190	Ø 175
5	50	215	Ø 200

- _ Apparecchio a LED da incasso in materiale termoplastico con alimentatore integrato
- _ Leggeri ed ideali per controsoffitti
- _ Corpo bianco in termoplastica e metallo, con diffusore in termoplastico satinato anti abbagliamento
- _ Completo di morsetto per un cablaggio semplificato
- _ CCT selezionabile

- _ Recessed LED luminaire in thermoplastic material with integrated power supply
- _ Lightweight and ideal for false ceilings
- _ White body in thermoplastic and metal, with satin thermoplastic diffuser anti glare
- _ Complete with terminal for simplified wiring
- _ Selectable CCT

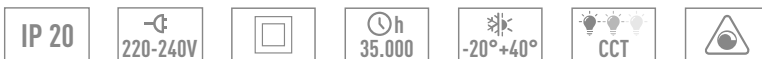

W	K	LUMEN APPARECCHIO lm	MISURE	VARIANTE	CODICE	EAN			
4	3000 4200 6500	380	100° 1	-	BODO4	8031453025779	1/20	ATG	F
8	3000 4200 6500	780	100° 2	-	BODO8	8031453025786	1/20	ATG	F
16	3000 4200 6500	1700	100° 3	-	BODO16	8031453025793	1/20	ATG	F
20	3000 4200 6500	2150	100° 4	-	BODO20	8031453025809	1/20	ATG	F
24	3000 4200 6500	2650	100° 5	-	BODO24	8031453025816	1/20	ATG	F

DOWNLIGHT BODO II CCT DIMMERABILE

NEW

BTL CATEGORIA SCONTO 23

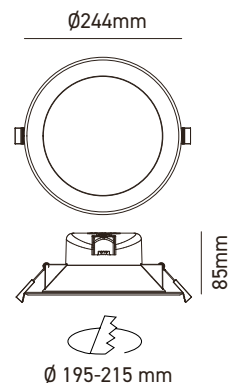

- _ Apparecchio a LED da incasso in materiale termoplastico con alimentatore integrato
- _ Protezione frontale IP44, posteriore IP20
- _ Disponibile modulo emergenza che garantisce 3 ore di autonomia a 350 lumen
- _ CCT selezionabile

- _ Recessed LED luminaire in thermoplastic material with integrated power supply
- _ IP44 front, IP20 rear protection
- _ Emergency module available, providing 3 hours of autonomy at 350 lumens
- _ Selectable CCT



W	K	LUMEN SORGENTE lm		VARIANTE	CODICE	EAN		
24	<input type="checkbox"/> 3000 <input type="checkbox"/> 4000 <input type="checkbox"/> 6500	2800	100°	-	BODOII24KD	8031453033958	1/8	
BODO II - KIT EMERGENZA 3h / BODO II - EMERGENCY KIT 3h					BODOIIE3	8031453033965	1	

DOWNLIGHT BODO

BTL CATEGORIA SCONTO 23

Downlight orientabile / Adjustable downlight

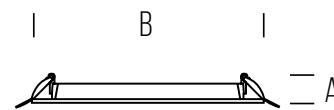

Dimensioni	A	B	Ø
1	46	85	Ø 75
2	84	140	Ø 125

- _ Apparecchio a LED da incasso in materiale termoplastico con alimentatore integrato
- _ Leggeri ed ideali per controsoffitti
- _ Corpo bianco in termoplastica e metallo, con diffusore in termoplastico satinato
- _ Versione orientabile
- _ Completo di morsetto per un cablaggio semplificato

- _ Recessed LED luminaire in thermoplastic material with integrated power supply
- _ Lightweight and ideal for false ceilings
- _ White body in thermoplastic and metal, with satin thermoplastic diffuser
- _ Adjustable version
- _ Complete with terminal for simplified wiring



W	K	LUMEN APPARECCHIO lm	MISURE	VARIANTE	CODICE	EAN	1/20	ATG
6	3000	425	36°	1	BODO620	8031453025823	1/20	ATG G
6	4000	425	36°	1	BODO630	8031453025830	1/20	ATG G
20	3000	1530	36°	2	BODO2020	8031453026011	1/20	ATG F
20	4000	1530	36°	2	BODO2030	8031453026028	1/20	ATG F



BODO

ANELLI DI FISSAGGIO ORIENTABILI ADJUSTABLE FIXING RINGS





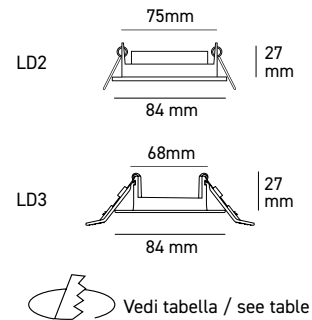



AGGIORNATO

BTL CATEGORIA
SCONTO 23



_ Faretto orientabile per montaggio ad incasso, realizzato in fusione di alluminio
_ Alloggia lampade alogene e LED diametro 50mm con base GU10-G4 (portalampada non fornito)

_ Recessed adjustable spotlight, made from die-cast aluminium
_ Houses 50mm diameter halogen and LED bulbs with GU10 - G4 base (lampholder not supplied)

	VARIANTE	 \varnothing mm	CODICE	EAN	
NEW	 CIRCOLARE ARGENTO / CIRCULAR SILVER	75	LD2SPTA01A	8031453020712	1/100
	 CIRCOLARE BIANCO / CIRCULAR WHITE	75	LD2SPTA01B	8031453020729	1/100
NEW	 CIRCOLARE SPAZZOLATO / CIRCULAR BRUSHED	75	LD2SPTA01S	8031453020736	1/100
	 QUADRATO ARGENTO / SILVER SQUARE	68 - 75	LD3SPTA02A	8031453025977	1/100
NEW	 QUADRATO BIANCO / WHITE SQUARE	75	LD2SPTA02B	8031453020750	1/100
	 QUADRATO SPAZZOLATO / BRUSHED SQUARE	68 - 75	LD3SPTA02S	8031453025991	1/100

ANELLO DI FISSAGGIO FISSO CON VETRO FRONTALE IP65 IP65 FIXING RING WITH FRONT GLASS

AGGIORNATO

BTL CATEGORIA
SCONTO 23



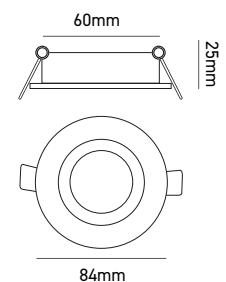

IP 65



 Vedi tabella / see table

_ Faretto per montaggio ad incasso, realizzato in fusione di alluminio
_ Alloggia lampade alogene e LED diametro 50mm con base GU10-G4 (portalampada non fornito)
_ Vetro di protezione per garantire l'indice di protezione IP65

_ Recessed spotlight, made from die-cast aluminium
_ Houses 50mm diameter halogen and LED bulbs with GU10 - G4 base (lampholder not supplied)
_ IP65 protection ensured by front glass

	VARIANTE	 \varnothing mm	CODICE	EAN	
	 CIRCOLARE BIANCO IP65 / CIRCULAR WHITE IP65	60 - 76	LD3SPTA91B	8031453026004	1/100

ANELLI DI FISSAGGIO ORIENTABILI PER GU10 ADJUSTABLE FIXING RINGS FOR GU10

AGGIORNATO

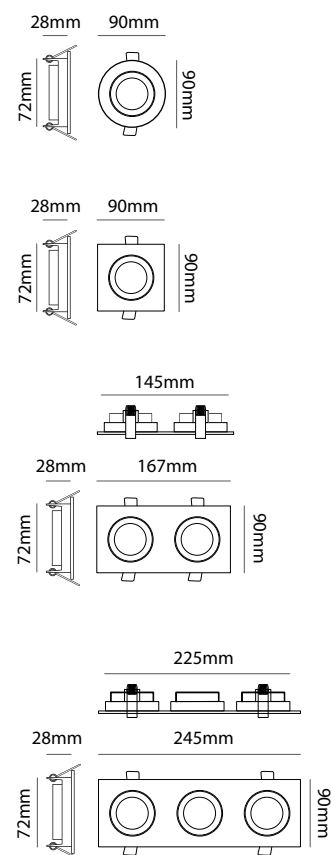

BTL CATEGORIA SCONTO 23



- _ Faretto orientabile per montaggio ad incasso, realizzato in fusione di alluminio
- _ Alloggia lampade alogene e LED diametro 50mm con base GU10-G4 (portalampada non fornito)
- _ Disponibile in versione uno, due o tre slot

- _ Recessed adjustable spotlight, made from die-cast aluminium
- _ Houses 50mm diameter halogen and LED bulbs with GU10 - G4 base (lampholder not supplied)
- _ One, two or three slot available

IP 20

VARIANTE	 Ø mm	CODICE	EAN		
<input type="checkbox"/> ROTONDO BIANCO 1 SLOT / WHITE ROUND 1 SLOT	72-80	LD4SPTB01B	8031453033750	1/100	NEW
<input checked="" type="checkbox"/> ROTONDO NERO 1 SLOT / BLACK ROUND 1 SLOT	72-80	LD4SPTB01N	8031453033767	1/100	NEW
<input type="checkbox"/> QUADRATO BIANCO 1 SLOT / WHITE SQUARE 1 SLOT	72-80	LD4SPTA01B	8031453031602	1/100	
<input checked="" type="checkbox"/> QUADRATO NERO 1 SLOT / BLACK SQUARE 1 SLOT	72-80	LD4SPTA01N	8031453031619	1/100	
<input type="checkbox"/> QUADRATO BIANCO 2 SLOT / WHITE SQUARE 2 SLOTS	75x150	LD4SPTA02B	8031453031626	1/50	
<input checked="" type="checkbox"/> QUADRATO NERO 2 SLOT / BLACK SQUARE 2 SLOTS	75x150	LD4SPTA02N	8031453031633	1/50	
<input type="checkbox"/> QUADRATO BIANCO 3 SLOT / WHITE SQUARE 3 SLOTS	75x230	LD4SPTA03B	8031453031640	1/50	
<input checked="" type="checkbox"/> QUADRATO NERO 3 SLOT / BLACK SQUARE 3 SLOTS	75x230	LD4SPTA03N	8031453031657	1/50	





SHOT
BOT LIGHTING

TECNICO / TECHNICAL
TRACK LIGHTS



BERNA

BTL CATEGORIA SCONTO 23

Sospensione da binario / Track pendant

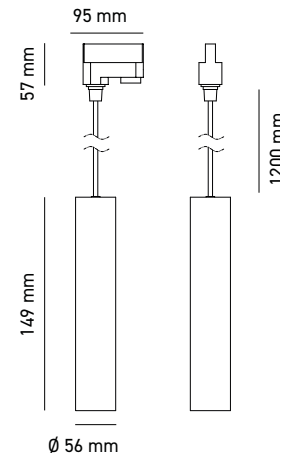

- _ Sospensione tubolare con corpo pressofuso in alluminio
- _ Adattatore per binario 3 fasi
- _ Lunghezza cavo 120cm
- _ GU10 max 7W
- _ Verniciatura a polveri resistente ai raggi UV

- _ Tubular pendant with die-cast aluminum body
- _ 3-phase track adapter
- _ Cable length 120cm
- _ GU10 max 7W
- _ UV-resistant powder coating



W	BASE		VARIANTE	CODICE	EAN	
-	GU10	-	<input type="checkbox"/> BIANCO / WHITE	BERNAB	8031453027858	1/20
-	GU10	-	<input checked="" type="checkbox"/> NERO / BLACK	BERNAN	8031453027841	1/20

ZURIGO

BTL CATEGORIA SCONTO 23

Lampada a sospensione / Pendant lamp

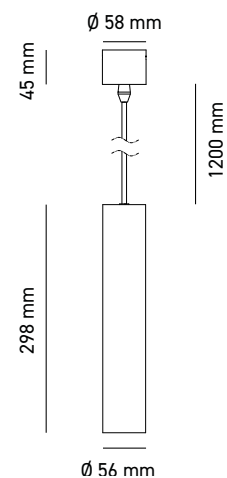

- _ Sospensione tubolare con corpo pressofuso in alluminio
- _ Attacco da soffitto con rosone
- _ Lunghezza cavo 120cm
- _ GU10 max 7W
- _ Verniciatura a polveri resistente ai raggi UV

- _ Tubular pendant with die-cast aluminum body
- _ Ceiling attachment with canopy
- _ Cable length 120cm
- _ GU10 max 7W
- _ UV-resistant powder coating



BASE		VARIANTE	CODICE	EAN	
GU10	-	<input type="checkbox"/> BIANCO / WHITE	ZURIGOB	8031453027872	1/20
GU10	-	<input checked="" type="checkbox"/> NERO / BLACK	ZURIGON	8031453027865	1/20
GU10	-	<input checked="" type="checkbox"/> CORTEN	ZURIGOC	8031453028039	1/20

GRAZ

Proiettore da binario / Tracklight

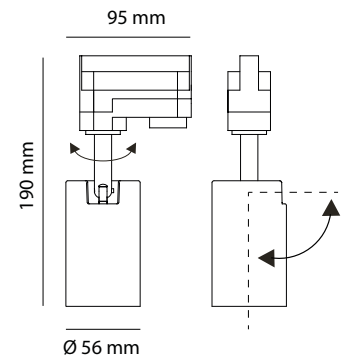

- _ Faretto da binario con corpo pressofuso in alluminio
- _ Adattatore per binario 3 fasi
- _ Orientabile a 360°
- _ GU10 max 7W
- _ Verniciatura a polveri resistente ai raggi UV

- _ Track spotlight with die-cast aluminum body
- _ 3-phase track adapter
- _ 360° adjustable
- _ GU10 max 7W
- _ UV-resistant powder coating



W	BASE		VARIANTE	CODICE	EAN	
-	GU10	-	<input type="checkbox"/> BIANCO / WHITE	GRAZB	8031453027810	1/24
-	GU10	-	<input checked="" type="checkbox"/> NERO / BLACK	GRAZN	8031453027803	1/24

LINZ

BTL CATEGORIA SCONTO 23

Faretto spot / Spotlight

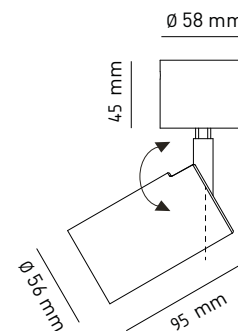

- _ Faretto spot con corpo pressofuso in alluminio
- _ Attacco da soffitto con rosone
- _ Orientabile a 360°
- _ GU10 max 7W
- _ Verniciatura a polveri resistente ai raggi UV

- _ Spotlight with die-cast aluminum body
- _ Ceiling attachment with canopy
- _ 360° adjustable
- _ GU10 max 7W
- _ UV-resistant powder coating



W	BASE		VARIANTE	CODICE	EAN	
-	GU10	-	BIANCO / WHITE	LINZB	8031453027834	1/24
-	GU10	-	NERO / BLACK	LINZN	8031453027827	1/24
-	GU10	-	CORTEN	LINZC	8031453028022	1/24

WELS NEW

BTL CATEGORIA SCONTO 23

Proiettore da binario / Tracklight

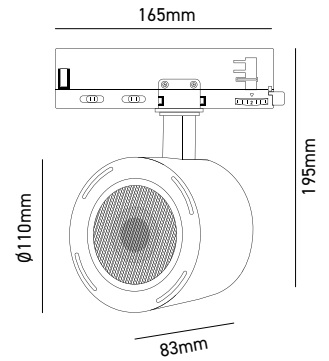

- _ Proiettore da binario in alluminio
- _ Possibilità di regolare il fascio da 24° a 60° in modo continuo ruotando la ghiera
- _ Basso abbagliamento UGR<13 e alta resa cromatica CRI>92
- _ Potenza e CCT selezionabili

- _ Aluminium tracklight
- _ Adjustable beam angle from 24° to 60° by rotating the ring
- _ Low glare with UGR < 13 and high color rendering index CRI > 92
- _ Power and CCT selectable



W	K	LUMEN APPARECCHIO lm	LUMEN SORGENTE lm		VARIANTE	CODICE	EAN		
30	2700	2000	3300	24-60°	□ BIANCO / WHITE	WELS40B	8031453034559	1/10	
34	3000	2200	3500						
40	4000	2500	4200						
30	2700	2000	3300	24-60°	■ NERO / BLACK	WELS40N	8031453034566	1/10	
34	3000	2200	3500						
40	4000	2500	4200						



WELS

VIENNA 30W CRI>97

BTL CATEGORIA SCONTO 23

Proiettore da binario / Tracklight

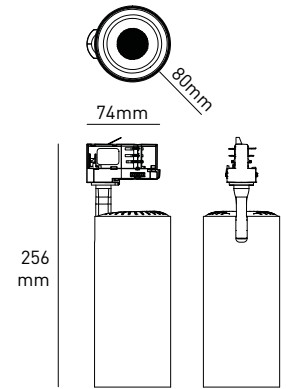

- _ Proiettore per binario ad alta potenza
- _ Driver integrato nell'elemento cilindrico
- _ Corpo in alluminio verniciato bianco o nero
- _ Adattatore per binario a 3 fasi
- _ Disponibili 2 temperature di colore con fasci 24°, 36° e 64°

- _ High power track light
- _ Built-in driver
- _ White or black aluminium body
- _ 3-phase track adapter
- _ Available in 2 colour temperatures and 3 beams 24°, 36° and 64°



W	K	LUMEN APPARECCHIO lm	LUMEN SORGENTE lm	△	VARIANTE	CODICE	EAN	📦	🌿
30	3000	2400	2900	24°	☐ BIANCO / WHITE	VIENNA3022B	8031453022228	1/10	ATG F
30	4000	2500	2950	24°	☐ BIANCO / WHITE	VIENNA3023B	8031453022242	1/10	ATG F
30	3000	2400	2900	36°	☐ BIANCO / WHITE	VIENNA3032B	8031453022174	1/10	ATG F
30	4000	2500	2950	36°	☐ BIANCO / WHITE	VIENNA3033B	8031453022198	1/10	ATG F
30	3000	2400	2900	64°	☐ BIANCO / WHITE	VIENNA3052B	8031453024833	1/10	ATG F
30	4000	2500	2950	64°	☐ BIANCO / WHITE	VIENNA3053B	8031453024857	1/10	ATG F
30	3000	2400	2900	24°	■ NERO / BLACK	VIENNA3022N	8031453022235	1/10	ATG F
30	4000	2500	2950	24°	■ NERO / BLACK	VIENNA3023N	8031453022259	1/10	ATG F
30	3000	2400	2900	36°	■ NERO / BLACK	VIENNA3032N	8031453022181	1/10	ATG F
30	4000	2500	2950	36°	■ NERO / BLACK	VIENNA3033N	8031453022204	1/10	ATG F
30	3000	2400	2900	64°	■ NERO / BLACK	VIENNA3052N	8031453024840	1/10	ATG F
30	4000	2500	2950	64°	■ NERO / BLACK	VIENNA3053N	8031453024864	1/10	ATG F

VIENNA3022B

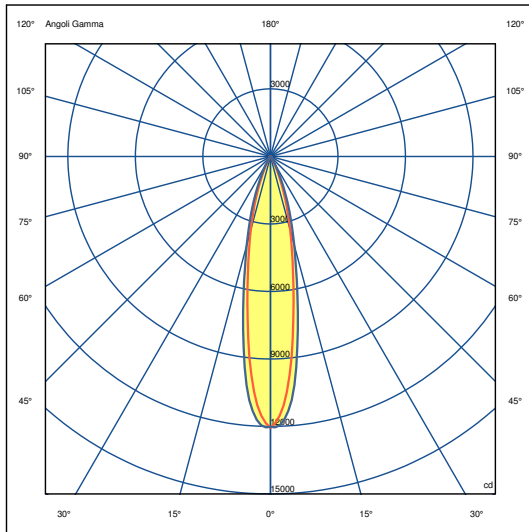

VIENNA3023B

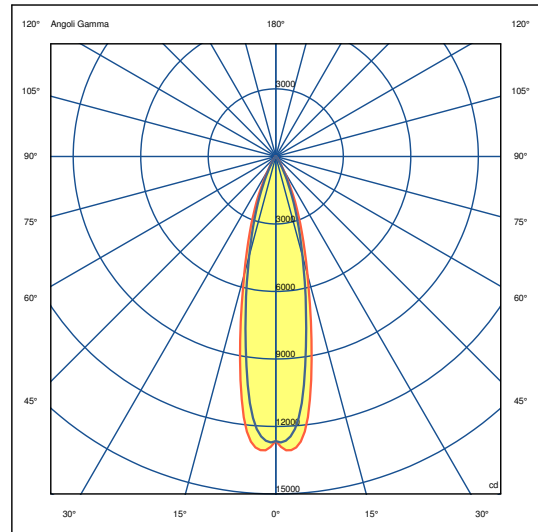

VIENNA3032B

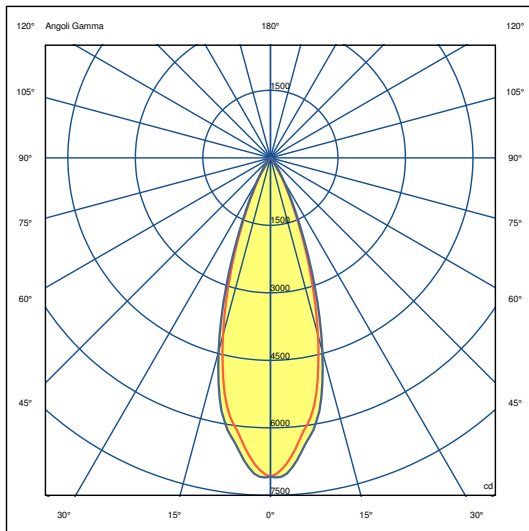

VIENNA3033B

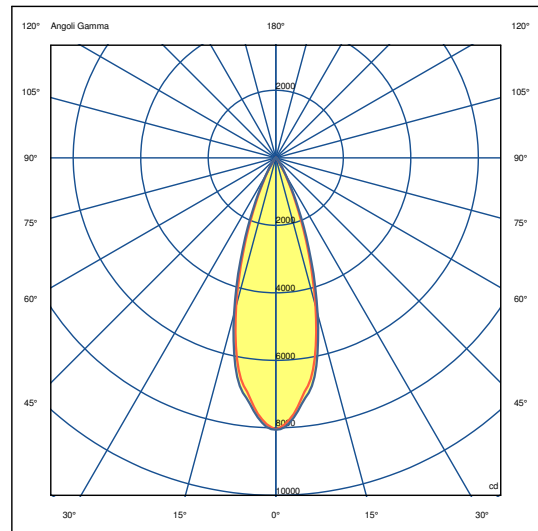

VIENNA3052B

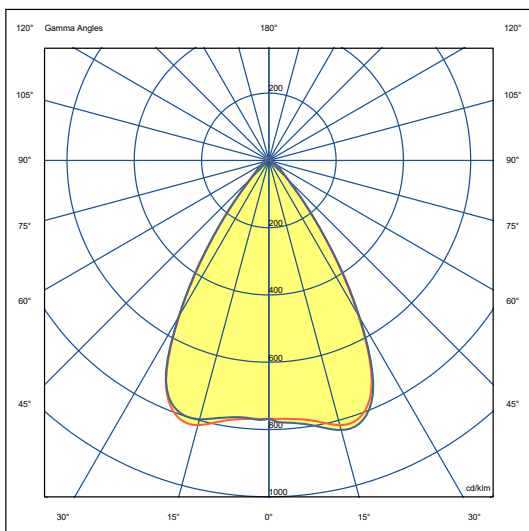

VIENNA3053B

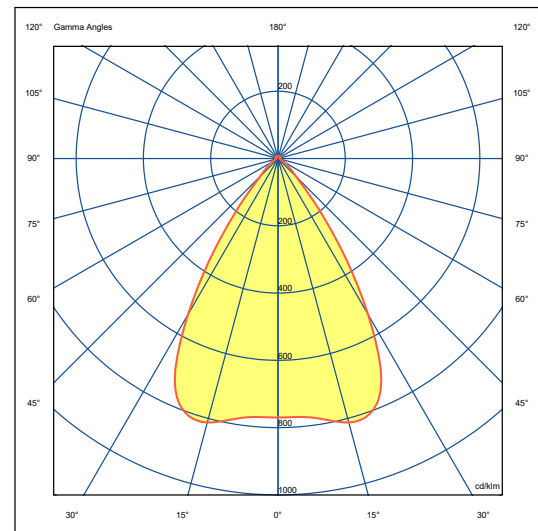

VIENNA 40W CRI>90

BTL CATEGORIA SCONTO 23

Proiettore da binario / Tracklight

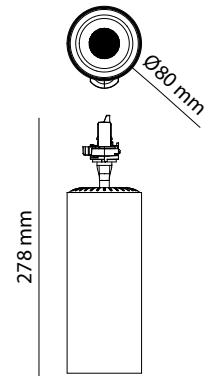
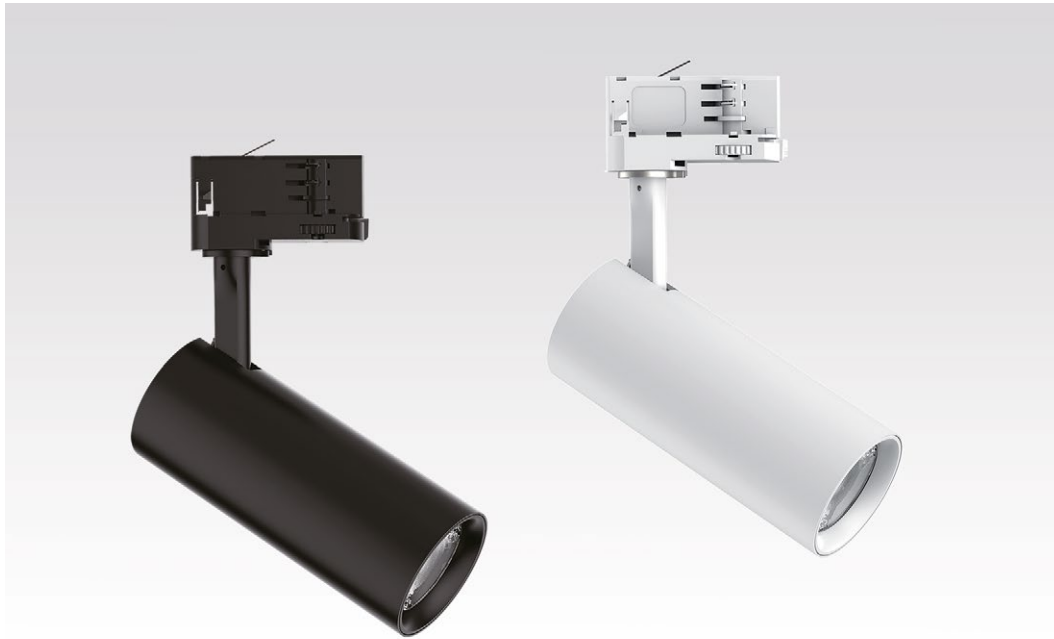

- _ Proiettore per binario ad alta potenza
- _ Driver integrato nell'elemento cilindrico
- _ Corpo in alluminio verniciato bianco o nero
- _ Adattatore per binario a 3 fasi
- _ Disponibili 2 temperature di colore con fasci 24°, 36° e 64°

- _ High power track light
- _ Built-in driver
- _ White or black aluminium body
- _ 3-phase track adapter
- _ Available in 2 colour temperatures and 24°, 36° and 64° beams



W	K	LUMEN APPARECCHIO lm	LUMEN SORGENTE lm	Beam Angle	VARIANTE	CODICE	EAN	Box	Energy
40	3000	2950	3800	24°	BIANCO / WHITE	VIENNA4022B	8031453028626	1/10	A T G F
40	4000	3000	3850	24°	BIANCO / WHITE	VIENNA4023B	8031453028640	1/10	A T G F
40	3000	2950	3800	36°	BIANCO / WHITE	VIENNA4032B	8031453027889	1/10	A T G F
40	4000	3000	3850	36°	BIANCO / WHITE	VIENNA4033B	8031453027902	1/10	A T G F
40	3000	2950	3800	64°	BIANCO / WHITE	VIENNA4052B	8031453028664	1/10	A T G F
40	4000	3000	3850	64°	BIANCO / WHITE	VIENNA4053B	8031453028688	1/10	A T G F
40	3000	2950	3800	24°	NERO / BLACK	VIENNA4022N	8031453028633	1/10	A T G F
40	4000	3000	3850	24°	NERO / BLACK	VIENNA4023N	8031453028657	1/10	A T G F
40	3000	2950	3800	36°	NERO / BLACK	VIENNA4032N	8031453027896	1/10	A T G F
40	4000	3000	3850	36°	NERO / BLACK	VIENNA4033N	8031453027919	1/10	A T G F
40	3000	2950	3800	64°	NERO / BLACK	VIENNA4052N	8031453028671	1/10	A T G F
40	4000	3000	3850	64°	NERO / BLACK	VIENNA4053N	8031453028695	1/10	A T G F



VIENNA

BINARIO A 6 CONDUTTORI EUROSTANDARD PLUS

EUROSTANDARD PLUS 6 CONDUCTORS TRACK

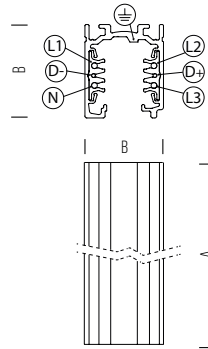
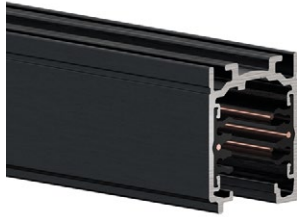

Dimensioni	A	B	C
1	37,8	31,4	1000
2	37,8	31,4	2000
3	37,8	31,4	3000
4	37,8	31,4	4000

IP 20



DESCRIZIONE	VARIANTE	MATERIALE	MISURE mm	CODICE	
BINARIO A 6 CONDUTTORI EUROSTANDARD PLUS METRI 1	<input checked="" type="checkbox"/> NERO / BLACK	ALLUMINIO / ALUMINUM	1	9000-1/B-ST	1
BINARIO A 6 CONDUTTORI EUROSTANDARD PLUS METRI 1	<input type="checkbox"/> BIANCO / WHITE	ALLUMINIO / ALUMINUM	1	9000-1/W-ST	1
BINARIO A 6 CONDUTTORI EUROSTANDARD PLUS METRI 2	<input checked="" type="checkbox"/> NERO / BLACK	ALLUMINIO / ALUMINUM	2	9000-2/B-ST	1
BINARIO A 6 CONDUTTORI EUROSTANDARD PLUS METRI 2	<input type="checkbox"/> BIANCO / WHITE	ALLUMINIO / ALUMINUM	2	9000-2/W-ST	1
BINARIO A 6 CONDUTTORI EUROSTANDARD PLUS METRI 3	<input checked="" type="checkbox"/> NERO / BLACK	ALLUMINIO / ALUMINUM	3	9000-3/B-ST	1
BINARIO A 6 CONDUTTORI EUROSTANDARD PLUS METRI 3	<input type="checkbox"/> BIANCO / WHITE	ALLUMINIO / ALUMINUM	3	9000-3/W-ST	1
BINARIO A 6 CONDUTTORI EUROSTANDARD PLUS METRI 4	<input checked="" type="checkbox"/> NERO / BLACK	ALLUMINIO / ALUMINUM	4	9000-4/B-ST	1
BINARIO A 6 CONDUTTORI EUROSTANDARD PLUS METRI 4	<input type="checkbox"/> BIANCO / WHITE	ALLUMINIO / ALUMINUM	4	9000-4/W-ST	1

TAPPO DI CHIUSURA PER BINARIO CON VITE DI BLOCCO

END CAP FOR TRACK WITH LOCKING SCREW

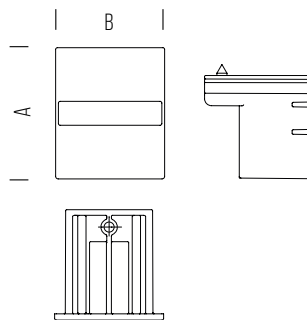

Dimensioni	A	B
1	37,8	31,4

IP 20



DESCRIZIONE	VARIANTE	MATERIALE	MISURE mm	CODICE	
TAPPO DI CHIUSURA PER BINARIO CON VITE DI BLOCCO	<input checked="" type="checkbox"/> NERO / BLACK	POLICARBONATO / POLYCARBONATE	1	9004/B	1
TAPPO DI CHIUSURA PER BINARIO CON VITE DI BLOCCO	<input type="checkbox"/> BIANCO / WHITE	POLICARBONATO / POLYCARBONATE	1	9004/W	1

GIUNTO A L POLARITA' ESTERNA

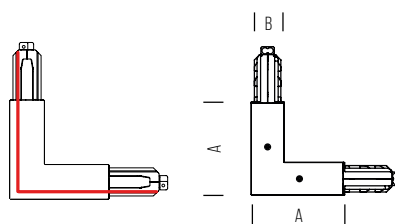

L-FEED - EXTERNAL POLARITY



Dimensioni	A	B
1	89,7	25,4

IP 20



DESCRIZIONE	VARIANTE	MATERIALE	MISURE mm	CODICE	
GIUNTO A L POLARITÀ ESTERNA	 NERO / BLACK	POLICARBONATO / POLYCARBONATE	1	9012/B	1
GIUNTO A L POLARITÀ ESTERNA	 BIANCO / WHITE	POLICARBONATO / POLYCARBONATE	1	9012/W	1

GIUNTO A L POLARITA' INTERNA

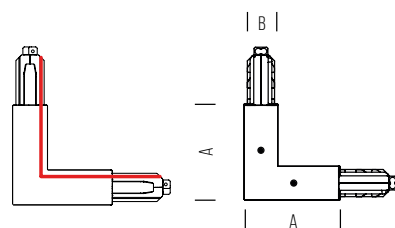

L-FEED - INTERNAL POLARITY



Dimensioni	A	B
1	89,7	25,4

IP 20



DESCRIZIONE	VARIANTE	MATERIALE	MISURE mm	CODICE	
GIUNTO A L POLARITÀ INTERNA	 NERO / BLACK	POLICARBONATO / POLYCARBONATE	1	9011/B	1
GIUNTO A L POLARITÀ INTERNA	 BIANCO / WHITE	POLICARBONATO / POLYCARBONATE	1	9011/W	1

TESTATA DI ALIMENTAZIONE POLARITA' DESTRA

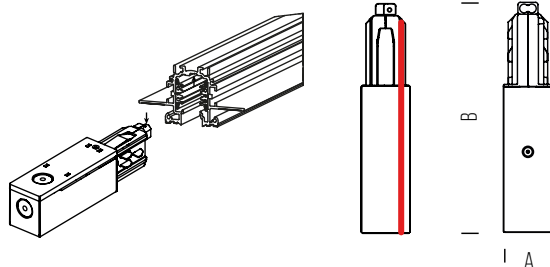

END-FEED - RIGHT



Dimensioni	A	B
1	95	31,4

IP 20



DESCRIZIONE	VARIANTE	MATERIALE	MISURE mm	CODICE	
TESTATA DI ALIMENTAZIONE POLARITÀ DESTRA	 NERO / BLACK	POLICARBONATO / POLYCARBONATE	1	9001/B	1
TESTATA DI ALIMENTAZIONE POLARITÀ DESTRA	 BIANCO / WHITE	POLICARBONATO / POLYCARBONATE	1	9001/W	1

TESTATA DI ALIMENTAZIONE POLARITA' SINISTRA

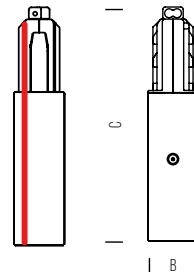
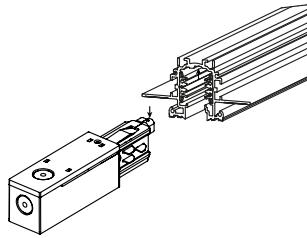

END-FEED - LEFT



Dimensioni	A	B
1	95	31,4

IP 20



DESCRIZIONE	VARIANTE	MATERIALE	MISURE mm	CODICE	
TESTATA DI ALIMENTAZIONE POLARITÀ SINISTRA	 NERO / BLACK	POLICARBONATO / POLYCARBONATE	1	9002/B	1
TESTATA DI ALIMENTAZIONE POLARITÀ SINISTRA	 BIANCO / WHITE	POLICARBONATO / POLYCARBONATE	1	9002/W	1

GIUNTO PASSANTE PER BINARIO

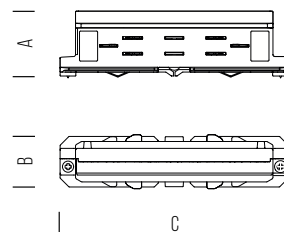
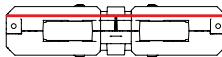

JOINTING CONNECTOR



Dimensioni	A	B	C
1	32,6	25,4	114,7
2	37,8	31,4	114,7

IP 20



DESCRIZIONE	VARIANTE	MATERIALE	MISURE mm	CODICE	
GIUNTO PASSANTE PER BINARIO	 NERO / BLACK	POLICARBONATO / POLYCARBONATE	1	9003/B	1
GIUNTO PASSANTE PER BINARIO	 BIANCO / WHITE	POLICARBONATO / POLYCARBONATE	2	9003/W	1

GIUNTO DIRETTO CON ALIMENTAZIONE DAL CENTRO

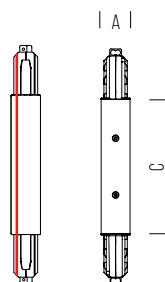
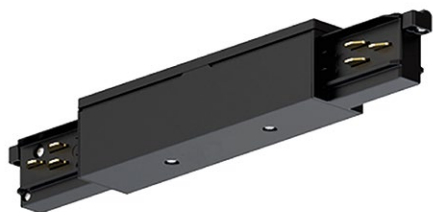

MIDDLE FEED FOR 2 CIRCUITS APPLICATION



Dimensioni	A	B	C
1	37,8	25,4	148

IP 20



DESCRIZIONE	VARIANTE	MATERIALE	MISURE mm	CODICE	
GIUNTO DIRETTO CON ALIMENTAZIONE DAL CENTRO	 NERO / BLACK	POLICARBONATO / POLYCARBONATE	1	9010/B	1
GIUNTO DIRETTO CON ALIMENTAZIONE DAL CENTRO	 BIANCO / WHITE	POLICARBONATO / POLYCARBONATE	1	9010/W	1

KIT COMPLETO PER FISSAGGIO A SOSPENSIONE BINARIO

COMPLETE SUSPENSION KIT FOR TRACK

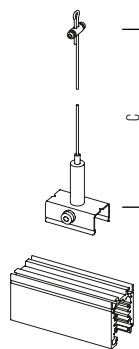

Dimensioni	C
1	1500
2	3000
3	5000

IP 20

DESCRIZIONE	VARIANTE	MATERIALE	MISURE mm	CODICE	
KIT COMPLETO PER FISSAGGIO A SOSPENSIONE BINARIO - 1,5 M	 ACCIAIO / STEEL	ACCIAIO / STEEL	1	9000-KIT1-1.5	1
KIT COMPLETO PER FISSAGGIO A SOSPENSIONE BINARIO - 3 M	 ACCIAIO / STEEL	ACCIAIO / STEEL	2	9000-KIT1-3	1
KIT COMPLETO PER FISSAGGIO A SOSPENSIONE BINARIO - 5 M	 ACCIAIO / STEEL	ACCIAIO / STEEL	3	9000-KIT1-5	1





SHOT
BOT LIGHTING

TECNICO / STRISCE LED
TECHNICAL / LED STRIP



HD LED STRIP IP20 24V

BTL CATEGORIA SCONTO 23

Striscia LED / LED Strip



- _ Striscia LED adesiva ad alta potenza
- _ Alta densità di LED per metro
- _ Lunghezza rotolo 5 metri (tagliabile in corrispondenza dei punti marcati sulla striscia)
- _ Accessori di connessione su richiesta

- _ High power adhesive LED strip
- _ Very high density of LEDs per meter
- _ Roll length 5 meters (can be cut at the points marked on the strip)
- _ Connection accessories on request



W/m	K	LUMEN lm/m		DIMENSIONE L x W x H mm	NUMERO LED/m	CUT SIZE mm	CODICE	EAN		
14	3000	1400	120°	5000 x 10 x 1,4	180	33	STR241593020-180	8031453028237	1/10	A ↑ G F
14	4000	1500	120°	5000 x 10 x 1,4	180	33	STR241594020-180	8031453028244	1/10	A ↑ G F
20	3000	1900	120°	5000 x 10 x 1,4	240	25	STR242093020-240	8031453028251	1/10	A ↑ G F
20	4000	2000	120°	5000 x 10 x 1,4	240	25	STR242094020-240	8031453028268	1/10	A ↑ G F

COLOR STRIP IP20 24V

BTL CATEGORIA SCONTO 23

Striscia LED / LED Strip

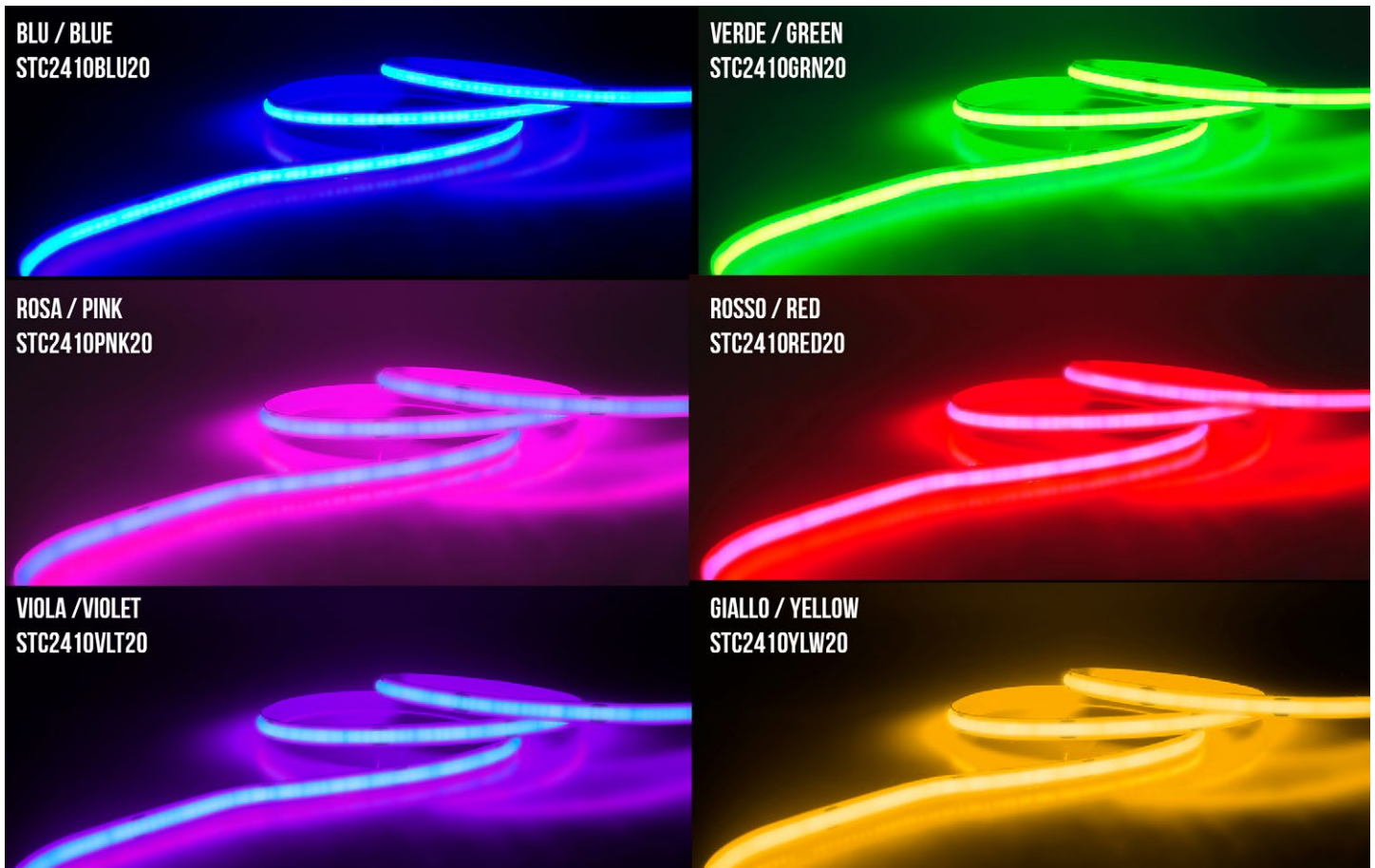

- _ Striscia LED colorata
- _ Lunghezza rotolo 5 metri (tagliabile in corrispondenza dei punti)
- _ Ottimo effetto decorativo con colori brillanti e uniformi grazie alla tecnologia dot free COB
- _ Accessori di connessione su richiesta

- _ Colored LED strip
- _ Roll length 5 meters (can be cut at the points marked on the strip)
- _ Excellent decorative effect with bright and uniform colors thanks to the dot free COB technology
- _ Connection accessories on request



W/m	LUMEN lm/m		DIMENSIONE L x W x H mm	CUT SIZE mm	VARIANTE	CODICE	EAN	
10	100	180°	5000 x 8 x 1,8	50	BLU / BLUE	STC2410BLU20	8031453028275	1/2
10	750	180°	5000 x 8 x 1,8	50	VERDE / GREEN	STC2410GRN20	8031453028282	1/2
10	500	180°	5000 x 8 x 1,8	50	ROSA / PINK	STC2410PNK20	8031453028299	1/2
10	200	180°	5000 x 8 x 1,8	50	ROSSO / RED	STC2410RED20	8031453028305	1/2
10	300	180°	5000 x 8 x 1,8	50	VIOLA / VIOLET	STC2410VLT20	8031453028312	1/2
10	500	180°	5000 x 8 x 1,8	50	GIALLO / YELLOW	STC2410YLW20	8031453028329	1/2

SMD LED STRIP IP20 24V

Striscia LED / LED Strip



- _ Striscia LED adesiva ad alta potenza
- _ Lunghezza rotolo 5 metri (tagliabile in corrispondenza dei punti marcati sulla striscia)
- _ Accessori di connessione su richiesta
- _ High power adhesive LED strip
- _ Roll length 5 meters (can be cut at the points marked on the strip)
- _ Connection accessories on request

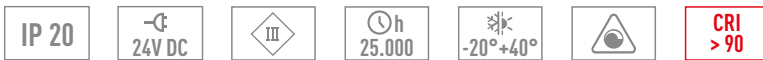

W/m	K	LUMEN lm/m		DIMENSIONE L x W x H mm	NUMERO LED/m	CUT SIZE mm	CODICE	EAN			
5,1	2200	450	120°	5000 x 8 x 1,4	60	100	STR240592220	8031453026578	1/10		
5,1	2700	480	120°	5000 x 8 x 1,4	60	100	STR240592720	8031453026585	1/10		
5,1	3000	480	120°	5000 x 8 x 1,4	60	100	STR240593020	8031453026592	1/10		
5,1	4000	510	120°	5000 x 8 x 1,4	60	100	STR240594020	8031453026608	1/10		
5,1	6500	510	120°	5000 x 8 x 1,4	60	100	STR240596520	8031453026615	1/10		
10,5	2200	860	120°	5000 x 8 x 1,4	120	50	STR241092220	8031453026660	1/10		
10,5	2700	930	120°	5000 x 8 x 1,4	120	50	STR241092720	8031453026677	1/10		
10,5	3000	930	120°	5000 x 8 x 1,4	120	50	STR241093020	8031453026684	1/10		
10,5	4000	1000	120°	5000 x 8 x 1,4	120	50	STR241094020	8031453026691	1/10		
10,5	6500	1000	120°	5000 x 8 x 1,4	120	50	STR241096520	8031453026707	1/10		
15,5	2700	1300	120°	5000 x 8 x 1,4	120	50	STR241592720	8031453026752	1/10		
15,5	3000	1300	120°	5000 x 8 x 1,4	120	50	STR241593020	8031453026769	1/10		
15,5	4000	1500	120°	5000 x 8 x 1,4	120	50	STR241594020	8031453026776	1/10		
15,5	6500	1500	120°	5000 x 8 x 1,4	120	50	STR241596520	8031453026783	1/10		
17	2700	1850	120°	5000 x 8 x 1,4	120	50	STR242092720	8031453026837	1/10		
17	3000	1850	120°	5000 x 8 x 1,4	120	50	STR242093020	8031453026844	1/10		
17	4000	2000	120°	5000 x 8 x 1,4	120	50	STR242094020	8031453026851	1/10		
17	6500	2000	120°	5000 x 8 x 1,4	120	50	STR242096520	8031453026868	1/10		

HD LED STRIP IP54 24V

Striscia LED / LED Strip



- _ Striscia LED adesiva ad alta potenza
 - _ Alta densità di LED per metro
 - _ Lunghezza rotolo 5 metri (tagliabile in corrispondenza dei punti marcati sulla striscia)
 - _ Grado di protezione IP54 (non adatta per usi esterni)
 - _ Accessori di connessione su richiesta
- _ High power adhesive LED strip
 - _ Very high density of LEDs per meter
 - _ Roll length 5 meters (can be cut at the points marked on the strip)
 - _ Degree of protection IP54 (not suitable for outdoor use)
 - _ Connection accessories on request

IP 54

24V DC

III

h
25.000

-20°+40°

CRI
> 90

W/m	K	LUMEN lm/m		DIMENSIONE L x W x H mm	NUMERO LED/m	CUT SIZE mm	CODICE	EAN		
14,5	2700	1350	120°	5000 x 8 x 2	196	36	STR241592754	8031453031336	1/10	
14,5	3000	1350	120°	5000 x 8 x 2	196	36	STR241593054	8031453031343	1/10	
14,5	4000	1450	120°	5000 x 8 x 2	196	36	STR241594054	8031453031350	1/10	
14,5	6500	1500	120°	5000 x 8 x 2	196	36	STR241596554	8031453031367	1/10	
17,5	2700	1700	120°	5000 x 8 x 2	196	36	STR242092754	8031453031374	1/10	
17,5	3000	1700	120°	5000 x 8 x 2	196	36	STR242093054	8031453031381	1/10	
17,5	4000	1850	120°	5000 x 8 x 2	196	36	STR242094054	8031453031398	1/10	
17,5	6500	2000	120°	5000 x 8 x 2	196	36	STR242096554	8031453031404	1/10	

SMD LED STRIP IP54 24V

BTL CATEGORIA SCONTO 23

Striscia LED / LED Strip



- Striscia LED adesiva ad alta potenza
- Lunghezza rotolo 5 metri (tagliabile in corrispondenza dei punti marcati sulla striscia)
- Grado di protezione IP54 (non adatta per usi esterni)
- Accessori di connessione su richiesta
- High power adhesive LED strip
- Roll length 5 meters (can be cut at the points marked on the strip)
- Degree of protection IP54 (not suitable for outdoor use)
- Connection accessories on request

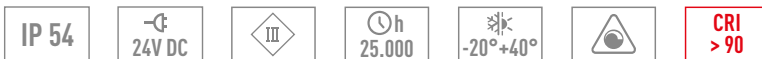

W/m	K	LUMEN lm/m		DIMENSIONE L x W x H mm	NUMERO LED/m	CUT SIZE mm	CODICE	EAN		
5,1	2700	450	120°	5000 x 8 x 2,5	60	100	STR240592754	8031453026622	1/10	
5,1	3000	450	120°	5000 x 8 x 2,5	60	100	STR240593054	8031453026639	1/10	
5,1	4000	480	120°	5000 x 8 x 2,5	60	100	STR240594054	8031453026646	1/10	
5,1	6500	510	120°	5000 x 8 x 2,5	60	100	STR240596554	8031453026653	1/10	
10,5	2700	860	120°	5000 x 8 x 2,5	120	50	STR241092754	8031453026714	1/10	
10,5	3000	860	120°	5000 x 8 x 2,5	120	50	STR241093054	8031453026721	1/10	
10,5	4000	930	120°	5000 x 8 x 2,5	120	50	STR241094054	8031453026738	1/10	
10,5	6500	1000	120°	5000 x 8 x 2,5	120	50	STR241096554	8031453026745	1/10	

SMD LED STRIP IP67 24V

Striscia LED / LED Strip



- _ Striscia LED adesiva ad alta potenza
- _ Lunghezza rotolo 5 metri (tagliabile in corrispondenza dei punti marcati sulla striscia)
- _ Il rivestimento in silicone garantisce l'indice di protezione IP67 e la resistenza ai raggi UV
- _ Accessori di connessione su richiesta

- _ High power adhesive LED strip
- _ Roll length 5 meters (can be cut at the points marked on the strip)
- _ The silicone coating guarantees the IP67 protection index and resistance to UV rays
- _ Connection accessories on request



W/m	K	LUMEN lm/m		DIMENSIONE L x W x H mm	NUMERO LED/m	CUT SIZE mm	CODICE	EAN			
15,5	2700	1250	120°	5000 x 10,5 x 5	120	50	STR241592767	8031453026790	1/10		
15,5	3000	1250	120°	5000 x 10,5 x 5	120	50	STR241593067	8031453026806	1/10		
15,5	4000	1450	120°	5000 x 10,5 x 5	120	50	STR241594067	8031453026813	1/10		
15,5	6500	1450	120°	5000 x 10,5 x 5	120	50	STR241596567	8031453026820	1/10		
17	2700	1800	120°	5000 x 10,5 x 5	120	50	STR242092767	8031453026875	1/10		
17	3000	1800	120°	5000 x 10,5 x 5	120	50	STR242093067	8031453026882	1/10		
17	4000	1950	120°	5000 x 10,5 x 5	120	50	STR242094067	8031453026899	1/10		
17	6500	1950	120°	5000 x 10,5 x 5	120	50	STR242096567	8031453026905	1/10		

CSP LED STRIP IP20 24V

BTL CATEGORIA SCONTO 23

Striscia LED / LED Strip

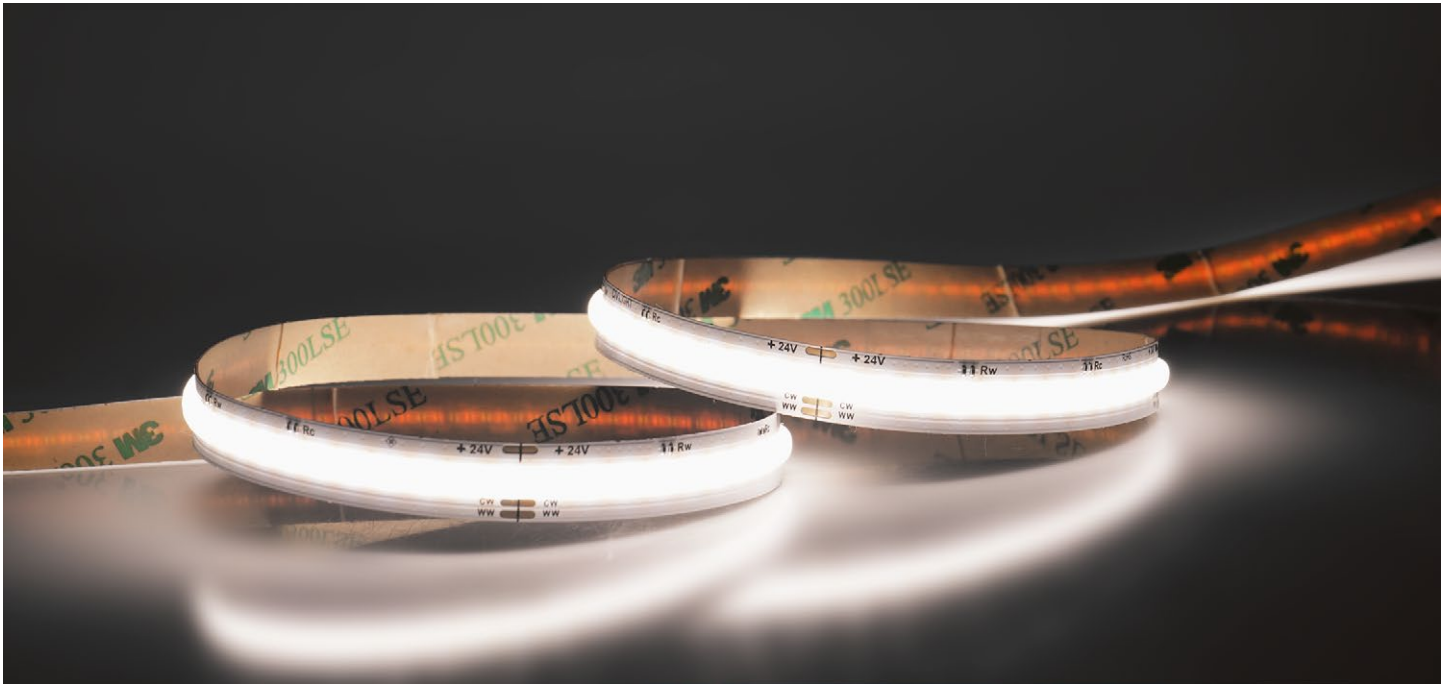

- _ Striscia LED adesiva ad alta potenza
- _ Lunghezza rotolo 5 metri (tagliabile in corrispondenza dei punti marcati sulla striscia)
- _ Luce confortevole ed uniforme grazie alla tecnologia 3D SMD LED
- _ Temperatura di colore regolabile tramite controller (venduto separatamente)
- _ Accessori di connessione su richiesta

- _ High power adhesive LED strip
- _ Roll length 5 meters (can be cut at the points marked on the strip)
- _ Comfortable and uniform light thanks to 3D SMD LED technology
- _ Color temperature adjustable via controller (sold separately)
- _ Connection accessories on request



W/m	K	LUMEN lm/m		DIMENSIONE L x W x H mm	NUMERO LED/m	CUT SIZE mm	CODICE	EAN			
12	2100 6500	1150	180°	5000 x 10 x 1,8	-	71	STC2412CCT20	4060574775076	1/2	A t G	
							Controller per LED Strip - Dip Switch	STCCON1	4060574370011	1/2	-
							Controller per LED Strip - Tuya Wi-Fi	STCCON2	4060574370172	1/2	-

COB LED STRIP IP20 24V













BTL CATEGORIA SCONTO 23

Striscia LED / LED Strip



- _ Striscia LED adesiva ad alta potenza
- _ Lunghezza rotolo 5 metri (tagliabile in corrispondenza dei punti marcati sulla striscia)
- _ Luce confortevole ed uniforme dot free grazie alla tecnologia COB
- _ Accessori di connessione su richiesta
- _ High power adhesive LED strip
- _ Roll length 5 meters (can be cut at the points marked on the strip)
- _ Comfortable and uniform dot free light thanks to COB technology
- _ Connection accessories on request



W/m	K	LUMEN lm/m		DIMENSIONE L x W x H mm	NUMERO LED/m	CUT SIZE mm	CODICE	EAN		
10	 2100	600	180°	5000 x 8 x 1,8	-	50	STC241092120	8031453026912	1/2	
10	 2700	750	180°	5000 x 8 x 1,8	-	50	STC241092720	8031453026929	1/2	
10	 3000	800	180°	5000 x 8 x 1,8	-	50	STC241093020	8031453026936	1/2	
10	 4000	850	180°	5000 x 8 x 1,8	-	50	STC241094020	8031453026943	1/2	
10	 6000	900	180°	5000 x 8 x 1,8	-	50	STC241096020	8031453026950	1/2	

COB LED STRIP IP20 48V

BTL CATEGORIA SCONTO 23

Striscia LED / LED Strip



- _ Striscia LED adesiva ad alta potenza
- _ Lunghezza rotolo 5/10 metri (tagliabile in corrispondenza dei punti marcati sulla striscia)
- _ Luce confortevole ed uniforme grazie alla tecnologia 3D SMD LED
- _ Accessori di connessione su richiesta

- _ High power adhesive LED strip
- _ Roll length 5/10 meters (can be cut at the points marked on the strip)
- _ Comfortable and uniform light thanks to 3D SMD LED technology
- _ Connection accessories on request



W/m	K	LUMEN lm/m		DIMENSIONE L x W x H mm	NUMERO LED/m	CUT SIZE mm	CODICE	EAN		
15	2700	1200	180°	5000 x 10 x 1,8	-	83	STC481592720	8031453026967	1/2	
15	2700	1200	180°	10000 x 10 x 1,8	-	83	STC481592720-10	8031453027001	1/2	
15	3000	1275	180°	5000 x 10 x 1,8	-	83	STC481593020	8031453026974	1/2	
15	3000	1275	180°	10000 x 10 x 1,8	-	83	STC481593020-10	8031453027018	1/2	
15	4000	1350	180°	5000 x 10 x 1,8	-	83	STC481594020	8031453026981	1/2	
15	4000	1350	180°	10000 x 10 x 1,8	-	83	STC481594020-10	8031453027025	1/2	
15	6000	1425	180°	5000 x 10 x 1,8	-	83	STC481596020	8031453026998	1/2	
15	6000	1425	180°	10000 x 10 x 1,8	-	83	STC481596020-10	8031453027032	1/2	

COB LED STRIP IP65 48V

BTL CATEGORIA SCONTO 23

Striscia LED / LED Strip



- Striscia LED adesiva ad alta potenza
- Lunghezza rotolo 5/10 metri (non tagliabile)
- Luce confortevole ed uniforme dot free grazie alla tecnologia COB
- Accessori di connessione su richiesta
- La tecnologia Nano Coating garantisce l'indice di protezione IP65, dissipazione ottimizzata e resistente ai raggi UV

- High power adhesive LED strip
- Roll length 5/10 meters (not cuttable)
- Comfortable and uniform dot free light thanks to COB technology
- Connection accessories on request
- The Nano Coating technology guarantees the IP65 protection index, optimized dissipation and UV resistant

IP 65
48V DC
III
40.000 h
-20°+40°
⚠
🏠
CRI >90

W/m	K	LUMEN lm/m	↻	DIMENSIONE L x W x H mm	NUMERO LED/m	CUT SIZE mm	CODICE	EAN	📦	🌱
15	3000	1275	180°	5000 x 10 x 1,8	-	-	STC481593065	4060574754699	1/2	A ↑ G G
15	3000	1275	180°	10000 x 10 x 1,8	-	-	STC481593065-10	4060574754811	1/2	A ↑ G G
15	4000	1350	180°	5000 x 10 x 1,8	-	-	STC481594065	4060574754705	1/2	A ↑ G G
15	4000	1350	180°	10000 x 10 x 1,8	-	-	STC481594065-10	4060574754828	1/2	A ↑ G G

TECNOLOGIA NANO COATING NANO COATING TECHNOLOGY

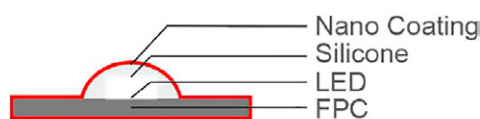



IP 20

DRIVER PER STRIP LED 12V

12V STRIP LED DRIVER

BTL CATEGORIA SCONTO 23

DESCRIZIONE	POTENZA MAX W	DIMENSIONI mm	CODICE	EAN		
Led driver 12V DC	6	43 x 82 x 23	LD1STRD06	8031453002565	1/100	
Led driver 12V DC	15	45 x 123 x 19	LD1STRD15	8031453001889	1/10	
Led driver 12V DC	30	52 x 166 x 24	LD1STRD30	8031453001896	1/10	
Led driver 12V DC	60	52 x 180 x 30	LD1STRD60	8031453001902	1/10	

DRIVER PER STRIP LED 24V

24V STRIP LED DRIVER

BTL CATEGORIA SCONTO 23

IP 20

DESCRIZIONE	POTENZA MAX W	DIMENSIONI mm	CODICE	EAN		
Led driver 24V DC	6	23 x 82 x 43	LD2STRD06	8031453019419	1/100	
Led driver 24V DC	15	19 x 123 x 45	LD2STRD15	8031453019426	1/10	
Led driver 24V DC	30	32 x 153 x 41	LD2STRD30	8031453019297	1/10	
Led driver 24V DC	60	30 x 180 x 52	LD2STRD60	8031453019303	1/10	
Led driver 24V DC	75	30 x 180 x 52	LD2STRD75	8031453019310	1/10	
Led driver 24V DC	120	40 x 300 x 30	LD2STRD120	8031453026561	1/10	

DRIVER PER STRIP LED 48V

48V LED STRIP DRIVER

BTL CATEGORIA SCONTO 23

IP 20

DESCRIZIONE	POTENZA MAX W	DIMENSIONI mm	CODICE	EAN		
Led driver 48V DC	75	52 x 180 x 30	LD3STRD75	8031453026547	1/10	
Led driver 48V DC	120	40 x 300 x 30	LD3STRD120	8031453026554	1/10	
Led driver 48V DC	150	30 x 322,5 x 21,5	LD3STRD150	4060574351034	1	

_ L'utilizzo dei caps di isolamento e dei cavi di interconnessione non garantiscono il grado IP iniziale delle strisce, pertanto si consiglia in abbinata a tali accessori di attuare degli accorgimenti tali (isolamento con silicone o altri sistemi) da poter considerare l'installazione di grado IP adeguato al luogo dove viene realizzata.

_ The use of insulation caps and interconnection cables do not guarantee the initial IP degree of the strips, therefore it is recommended in combination with these accessories to implement such precautions (insulation with silicone or other systems). The IP degree must be suitable for the place where the installation is made.

DIMMER PER STRIP LED

LED STRIP DIMMER

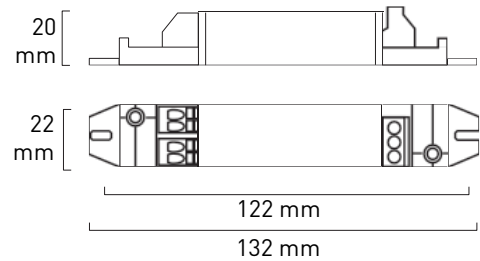

- _ Regolatore di luminosità per driver LED in tensione 12-48Vdc
- _ Push dimming
- _ DALI
- _ Dimming 1-10V
- _ Flicker free
- _ Tensione di alimentazione 12-48Vdc
- _ Massima corrente d'uscita 6A

- _ 12-48Vdc LED driver dimmer
- _ Push dimming (slow, fast profile, up/down)
- _ DALI
- _ 1-10V dimming
- _ Flicker free
- _ Input voltage 12-48Vdc
- _ Maximum output current 6A



POTENZA Watt	VARIANTE	CODICE	EAN	
72W@12V 144W@24V 288W@48V	Dali / push / 1-10V	DL-D/PMINI12-48	8031453032289	1/40

DIMMING SET

Dimming	Jumper position		
	1	2	3
1-10V	ON	ON	-
Push	-	ON	ON
DALI	-	-	-



Set jumper on pin 1 and 2 position for 1-10V



Set jumper on pin 2 and 3 position for Push



None jumper on pin 1, 2 and 3 position for DALI

Schema di collegamento DALI
Wiring diagram DALI

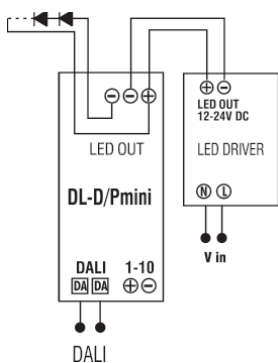

Schema di collegamento Push
Wiring diagram Push

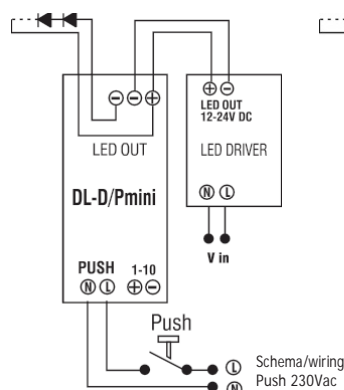

Schema di collegamento trimmer, 1/10V
Wiring diagram trimmer, 1/10V

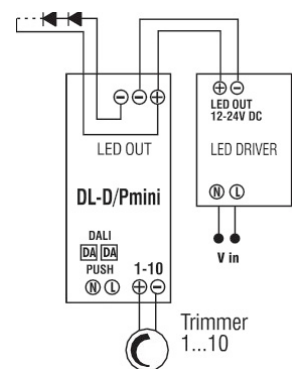

PROFILO SLIM - 2m

SLIM PROFILE - 2m

BTL CATEGORIA SCONTO 23

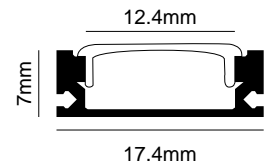
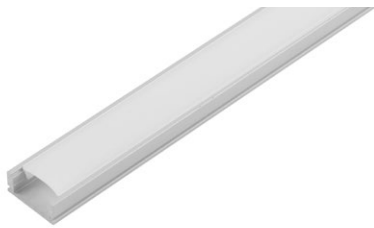



DESCRIZIONE	VARIANTE	MATERIALE	CODICE	EAN	
PROFILO SLIM IN ALLUMINIO PER LED STRIP - LUNGHEZZA 2M	ARGENTO / SILVER	ALLUMINIO / ALUMINUM	STP101A	8031453027049	1 *
PROFILO SLIM IN ALLUMINIO PER LED STRIP - LUNGHEZZA 2M	BIANCO / WHITE	ALLUMINIO / ALUMINUM	STP101B	8031453027056	1 *
PROFILO SLIM IN ALLUMINIO PER LED STRIP - LUNGHEZZA 2M	NERO /BLACK	ALLUMINIO / ALUMINUM	STP101N	8031453027063	1 *
CAPS PER PROFILO STP101 - 5 TAPPI CON FORO + 5 SENZA FORO	BIANCO / WHITE	PLASTICA / PLASTIC	STPC101B	8031453027667	1 *
CAPS PER PROFILO STP101 - 5 TAPPI CON FORO + 5 SENZA FORO	NERO /BLACK	PLASTICA / PLASTIC	STPC101N	8031453027674	1 *

PROFILO SLIM DA INCASSO - 2m

RECESSED SLIM PROFILE - 2m

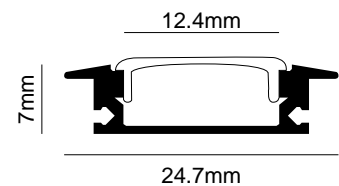
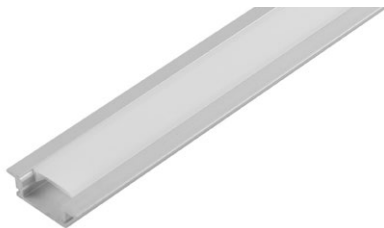
BTL CATEGORIA SCONTO 23



DESCRIZIONE	VARIANTE	MATERIALE	CODICE	EAN	
PROFILO DA INCASSO IN ALLUMINIO PER LED STRIP - LUNGHEZZA 2M	ARGENTO / SILVER	ALLUMINIO / ALUMINUM	STP201A	8031453027070	1 *
PROFILO DA INCASSO IN ALLUMINIO PER LED STRIP - LUNGHEZZA 2M	BIANCO / WHITE	ALLUMINIO / ALUMINUM	STP201B	8031453027094	1 *
PROFILO DA INCASSO IN ALLUMINIO PER LED STRIP - LUNGHEZZA 2M	NERO /BLACK	ALLUMINIO / ALUMINUM	STP201N	8031453027100	1 *
CAPS PER PROFILO STP201 - 5 TAPPI CON FORO + 5 SENZA FORO	BIANCO / WHITE	PLASTICA / PLASTIC	STPC201B	8031453027681	1 *
CAPS PER PROFILO STP201 - 5 TAPPI CON FORO + 5 SENZA FORO	NERO /BLACK	PLASTICA / PLASTIC	STPC201N	8031453027698	1 *

DISSIPATORE - 2m

HEATSINK - 2m

BTL CATEGORIA SCONTO 23

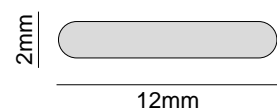
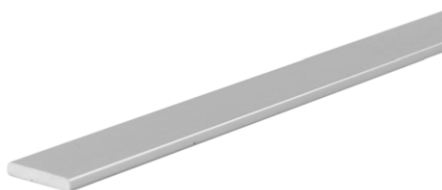

DESCRIZIONE	VARIANTE	MATERIALE	CODICE	EAN	
DISSIPATORE IN ALLUMINIO PER LED STRIP - LUNGHEZZA 2M	ARGENTO / SILVER	ALLUMINIO / ALUMINUM	STP102A	8031453027377	1 *

* Profili forniti con tappi e diffusore - ordine minimo 4 pezzi / Profiles supplied with caps and diffuser - minimum order 4 pcs

PROFILO INCASSO - 2m

RECESSED PROFILE - 2m

BTL CATEGORIA SCONTO 23

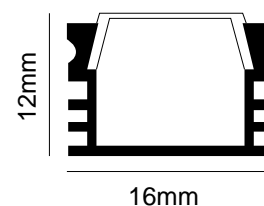
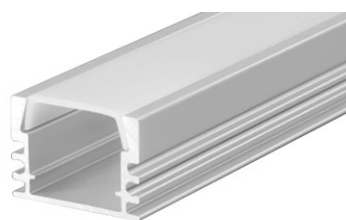

DESCRIZIONE	VARIANTE	MATERIALE	CODICE	EAN	
PROFILO DA INCASSO IN ALLUMINIO PER LED STRIP - LUNGHEZZA 2M	ARGENTO / SILVER	ALLUMINIO / ALUMINUM	STP202A	8031453027087	1 *
CAPS PER PROFILO STP202 - 5 TAPPI CON FORO + 5 SENZA FORO	BIANCO / WHITE	PLASTICA / PLASTIC	STPC202B	8031453027704	1 *

PROFILO ANGOLARE - 2m

CORNER PROFILE - 2m

BTL CATEGORIA SCONTO 23

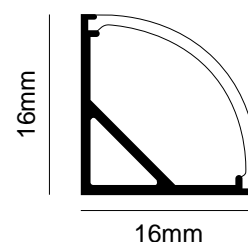

DESCRIZIONE	VARIANTE	MATERIALE	CODICE	EAN	
PROFILO ANGOLARE IN ALLUMINIO PER LED STRIP - LUNGHEZZA 2M	ARGENTO / SILVER	ALLUMINIO / ALUMINUM	STP301A	8031453027117	1 *
CAPS PER PROFILO STP301 - 5 TAPPI CON FORO + 5 SENZA FORO	BIANCO / WHITE	PLASTICA / PLASTIC	STPC301B	8031453027711	1 *

PROFILO PER CARTONGESSO - 2m

PLASTERBOARD PROFILE - 2m

BTL CATEGORIA SCONTO 23

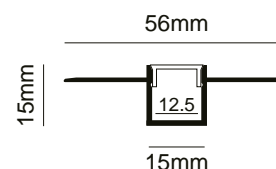

DESCRIZIONE	VARIANTE	MATERIALE	CODICE	EAN	
PROFILO PER CARTONGESSO IN ALLUMINIO PER LED STRIP - LUNGHEZZA 2M	ARGENTO / SILVER	ALLUMINIO / ALUMINUM	STP401A	8031453027124	1 **
CAPS PER PROFILO STP401 - 10 TAPPI CON FORO	BIANCO / WHITE	PLASTICA / PLASTIC	STPC401B	8031453027728	1 **

* Profili forniti con tappi e diffusore - ordine minimo 4 pezzi / Profiles supplied with caps and diffuser - minimum order 4 pcs
 ** Profili forniti con tappi e diffusore - ordine minimo 2 pezzi / Profiles supplied with caps and diffuser - minimum order 2 pcs

COMPATIBILITA' ACCESSORI STRISCE

STRIP ACCESSORIES COMPATIBILITY

	STR IP20	STR IP54	STR IP67	STC CCT	STC IP20 24V	STC IP20 48V	STC IP65
STCCA21					X		
STCCA22						X*	X*
STCCA3				X			
STRCA20	X						
STRCA54		X					
STRCA67			X				
STCCON1				X			
STCCON2				X			

*Non è garantito il grado di protezione IP della striscia dopo il taglio e con l'uso dei connettori se non effettuato a regola d'arte.
 *The IP protection degree of the strip after cutting and with the use of the connectors is not guaranteed if not carried out in a workmanlike manner.

BTL CATEGORIA SCONTO 23

BTL CATEGORIA SCONTO 23

CAVETTI DI ALIMENTAZIONE PER LED STRIP COB

COB LED STRIP POWER CABLES

CODICE	DESCRIZIONE	EAN		
STCCA21	8 MM - 2 CAVI / 2 CABLES	8031453027629	5	
STCCA22	10 MM - 2 CAVI / 2 CABLES	8031453027636	5	

CAVETTI DI ALIMENTAZIONE PER LED STRIP SMD

SMD LED STRIP POWER CABLES

CODICE	DESCRIZIONE	EAN		
STRCA20	8 MM - 2 CAVI / 2 CABLES	8031453027599	5	
STRCA54	8 MM - 2 CAVI / 2 CABLES	8031453027605	5	
STRCA67	10,5 MM - 2 CAVI / 2 CABLES	8031453027612	5	

BTL CATEGORIA SCONTO 23

ACCESSORI PER STRISCIA CSP

CSP STRIP ACCESSORIES

CODICE	DESCRIZIONE	EAN		
STCCON1	CONTROLLER PER LED STRIP - DIP SWITCH	4060574370011	1	
STCCON2	CONTROLLER PER LED STRIP - TUYA WI-FI	4060574370172	1	
STCCA3	10 MM - 3 CAVI / 3 CABLES	8031453027643	5	







SHOT
BOT LIGHTING

TECNICO / MODULI LED
TECHNICAL / LED MODULES



Modulo Led circolare magnetico / Magnetic circular Led module

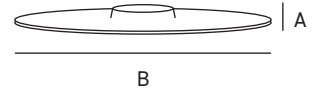
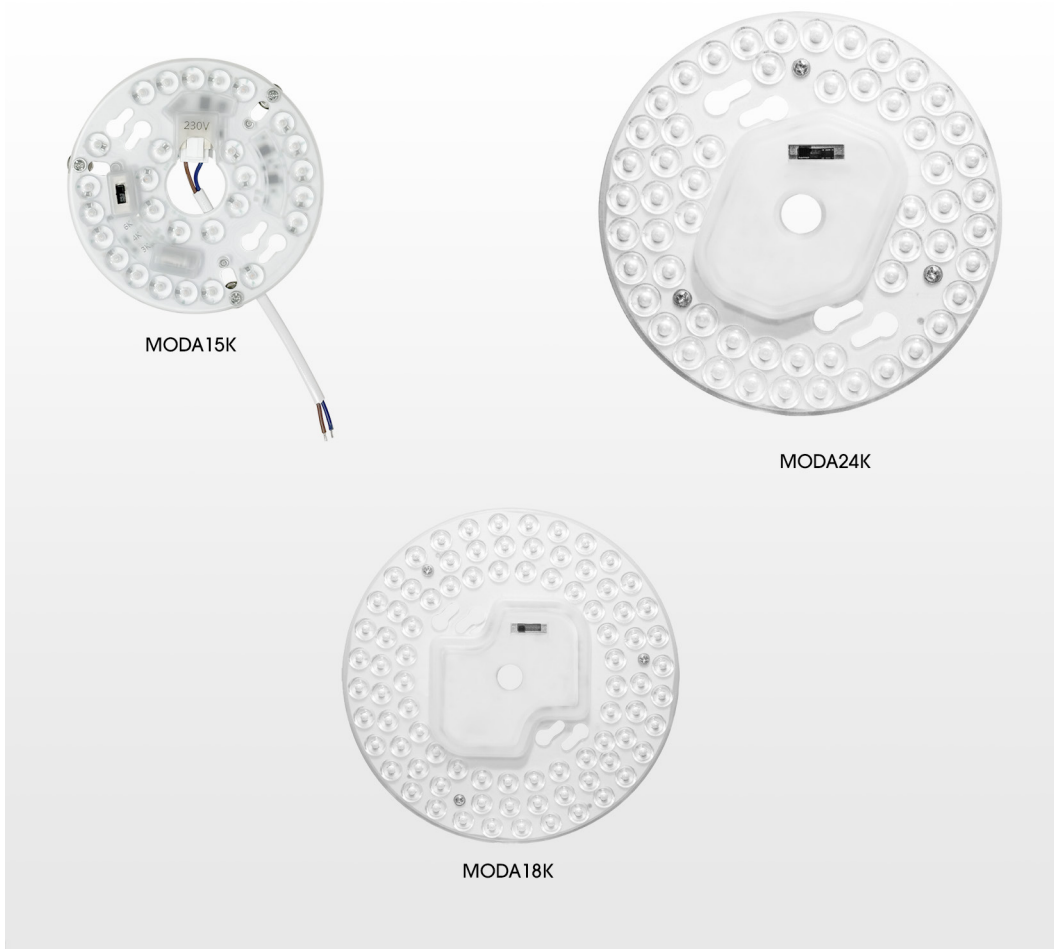

Dimensioni	A	B
1	12	120
2	12	135
3	12	170

- _ Modulo a LED con alimentatore incorporato per retrofit su plafoniere esistenti
- _ Installazione rapida grazie a supporti magnetici, necessita solo del collegamento dell'alimentazione (isolamento classe II)
- _ Disponibili diverse misure e potenze per adattarsi ai diversi apparecchi esistenti
- _ CCT selezionabile

- _ LED module with built-in driver to retrofit existing ceiling light fixtures.
- _ Quick installation thanks to magnetic supports, only requires connection to the power supply (insulation class II)
- _ Various sizes and power outputs available to adapt to different existing luminaires
- _ Selectable CCT



W	K	LUMEN SORGENTE lm	MISURE	VARIANTE	CODICE	EAN			
15	<input type="checkbox"/> 3000 <input type="checkbox"/> 4000 <input type="checkbox"/> 6000	1500	180° 1	-	MODA15K	8031453032654	1/10		
18	<input type="checkbox"/> 3000 <input type="checkbox"/> 4000 <input type="checkbox"/> 6000	1800	180° 2	-	MODA18K	8031453032661	1/10		
24	<input type="checkbox"/> 3000 <input type="checkbox"/> 4000 <input type="checkbox"/> 6000	2400	180° 3	-	MODA24K	8031453032678	1/10		

MOD-B

BTL CATEGORIA SCONTO 23

Modulo Led circolare magnetico / Magnetic circular Led module

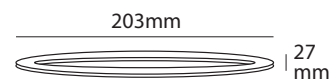

- _ Modulo a LED con alimentatore incorporato per retrofit su plafoniere esistenti
- _ Installazione rapida grazie a supporti magnetici, necessita solo del collegamento dell'alimentazione (isolamento classe II)
- _ Versione con foro centrale, ideale per sostituzione in plafoniere con foro passante

- _ LED module with built-in driver to retrofit existing ceiling light fixtures.
- _ Quick installation thanks to magnetic supports, only requires connection to the power supply (insulation class II)
- _ Central hole version, suitable for retrofit in pass-through hole fixtures

IP 20
220-240V
30.000h
-20°+40°
15.000
RoHS
Recycling

W	K	LUMEN APPARECCHIO lm	Beam angle	VARIANTE	CODICE	EAN	Box	Energy Class
20	3000	2200	160°	-	MODB202B	8031453021726	1/10	A+ E
20	4000	2300	160°	-	MODB203B	8031453021733	1/10	A+ E

Modulo Led circolare magnetico / Magnetic circular Led module

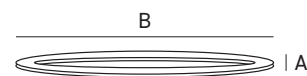

Dimensioni	A	B
1	22	215
2	22	285

- _ Modulo a LED con alimentatore incorporato per retrofit su plafoniere esistenti
- _ Installazione rapida grazie a supporti magnetici, necessita solo del collegamento dell'alimentazione (isolamento classe II)
- _ Disponibili diverse misure e potenze per adattarsi ai diversi apparecchi esistenti
- _ CCT selezionabile

- _ LED module with built-in driver to retrofit existing ceiling light fixtures.
- _ Quick installation thanks to magnetic supports, only requires connection to the power supply (insulation class II)
- _ Various sizes and power outputs available to adapt to different existing luminaires
- _ Selectable CCT



W	K	LUMEN SORGENTE lm	MISURE	VARIANTE	CODICE	EAN			
24	<input type="checkbox"/> 3000 <input type="checkbox"/> 4000 <input type="checkbox"/> 6000	2800	180°	1	-	MODC24K	8031453033972	1/30	
34	<input type="checkbox"/> 3000 <input type="checkbox"/> 4000 <input type="checkbox"/> 6000	4200	180°	2	-	MODC34K	8031453033989	1/15	

MODULO LED SLIM

NEW

BTL CATEGORIA SCONTO 23

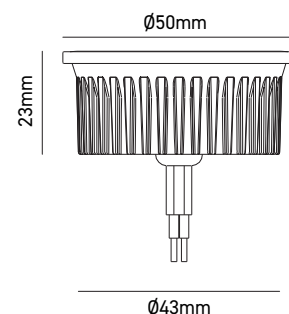
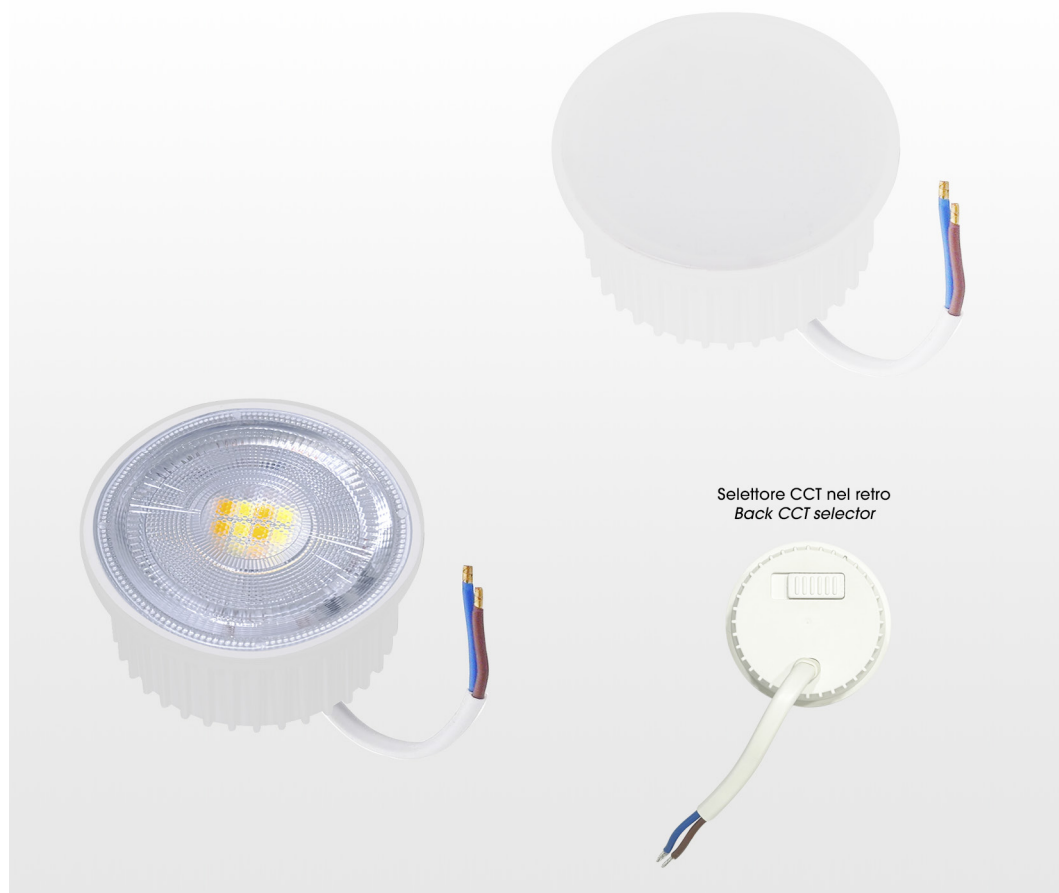

Adatto per anelli di fissaggio orientabili
vedi pagina

Suit for adjustable fixing rings
see page

185

- _ Adatto a anellini per sorgenti GU10
- _ Spessore ridotto per controsoffitti con altezza limitata
- _ Disponibile in due fasci luminosi e in variante dimmerabile
- _ CCT selezionabile

- _ Suitable for rings for GU10 light sources
- _ Reduced thickness for suspended ceilings with limited height
- _ Available in two beam angles and in a dimmable version
- _ Selectable CCT

IP 20
220-240V
25.000h
20.000
-20°+45°
CCT
*

W	K	LUMEN APPARECCHIO lm	Beam Angle	VARIANTE	CODICE	EAN	Box Qty	Energy Class
4,8	<input type="checkbox"/> 3000 <input type="checkbox"/> 4000 <input type="checkbox"/> 6500	610	38°	-	LD4SPT063K	8031453033682	10/200	A+G E
4,8	<input type="checkbox"/> 3000 <input type="checkbox"/> 4000 <input type="checkbox"/> 6500	610	38°	DIMMERABILE / DIMMABLE *	LD4SPT063KD	8031453033699	10/200	A+G E
5,0	<input type="checkbox"/> 3000 <input type="checkbox"/> 4000 <input type="checkbox"/> 6500	500	100°	-	LD4SPT065K	8031453033705	10/200	A+G F
5,0	<input type="checkbox"/> 3000 <input type="checkbox"/> 4000 <input type="checkbox"/> 6500	500	100°	DIMMERABILE / DIMMABLE *	LD4SPT065KD	8031453033712	10/200	A+G F

SEGOVIA LED

BTL CATEGORIA SCONTO 24

Accessorio / Accessory

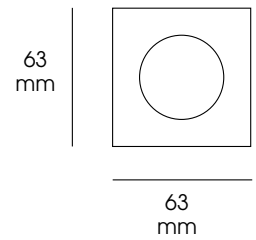

Per SEGOVIA1
vedi pagina

For SEGOVIA1
see page

360

- _ Modulo LED flicker-free per SEGOVIA
- _ Disponibile in versione 3000K e 4000K
- _ Installazione veloce, fissaggio con viti, piastra dissipante e lente in dotazione

- _ Flicker-free LED module for SEGOVIA
- _ Available in versions 3000K and 4000K
- _ Quick installation, screw fastening, heat sink and lens supplied



W	K	LUMEN APPARECCHIO lm		VARIANTE	CODICE	EAN		
10	3000	1100	180°	-	SEGOVIAMOD2	8031453020910	1	
10	4000	1250	180°	-	SEGOVIAMOD3	8031453020927	1	

LAGOS LED

BTL CATEGORIA SCONTO 24

Accessorio / Accessory



Per LAGOS1 - LAGOS2
vedi pagina

For LAGOS1 - LAGOS2
see page

362-364

_ Modulo LED flicker-free per LAGOS
_ CCT selezionabile

_ Flicker-free LED module for LAGOS
_ Selectable CCT



W	K	LUMEN APPARECCHIO lm		VARIANTE	CODICE	EAN			
9	<input type="checkbox"/> 3000 <input type="checkbox"/> 4000 <input type="checkbox"/> 5500	1000	180°	-	LAGOSMODK	8031453032272	1		





SHOT
BOT LIGHTING

**TECNICO / REGLETTE E
SISTEMI COMPONENTI**
TECHNICAL / REGLETTE AND
MODULAR SYSTEMS



EVA

Plafoniera flat Led CCT / CCT flat Led ceiling light

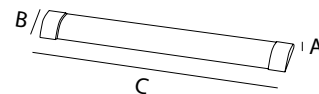

Dimensioni	A	B	C
1	25	75	600
2	25	75	1200
3	25	75	1500



- _ Plafoniera sigillata in policarbonato
- _ Design extra slim
- _ Alta efficienza fino a 110 lm/W
- _ Lunga durata grazie ai suoi materiali resistenti alla polvere e corrosione
- _ Applicazione a soffitto o a parete
- _ CCT selezionabile

- _ Polycarbonate sealed ceiling light
- _ Extra slim design
- _ High efficiency up to 110 lm/W
- _ Long life thanks to its dust and corrosion resistant materials
- _ Ceiling or wall application
- _ Selectable CCT



W	K	LUMEN APPARECCHIO lm	LUMEN SORGENTE lm	MISURE	VARIANTE	CODICE	EAN			
18	<input type="checkbox"/> 3000 <input type="checkbox"/> 4500 <input type="checkbox"/> 6500	2200	2600	120°	1	-	EVA18K	8031453028466	1/18	
36	<input type="checkbox"/> 3000 <input type="checkbox"/> 4500 <input type="checkbox"/> 6500	4300	4600	120°	2	-	EVA36K	8031453028473	1/18	
45	<input type="checkbox"/> 3000 <input type="checkbox"/> 4500 <input type="checkbox"/> 6500	5400	6500	120°	3	-	EVA45K	8031453028480	1/18	

LED T5 BAR NEW

BTL CATEGORIA SCONTO 23

Sistema modulare di barre Led / Led Modular system

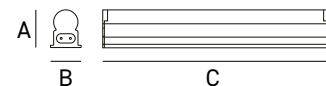

Dimensioni	A	B	C
1	34	23	300
2	34	23	572
3	34	23	1178

Compreso cavo di alimentazione da 150mm.

Including 150mm power cable.

Barre di potenze differenti possono essere connesse tra loro per una potenza complessiva di 220W.

Bars of different wattages can be connected to each other. Total power must not exceed 220W.

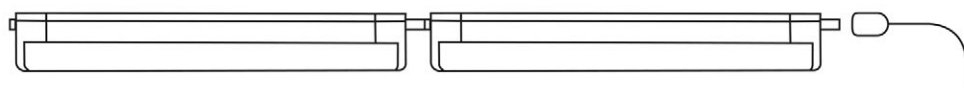

- Gamma completa di reglette a led in policarbonato con connettore integrato per giunzione diretta ed effetto lineare continuo
- Disponibili in tre misure e tre potenze
- Per ogni variante di misura e potenza, disponibile in versione 3000K e 4000K

- Complete range of polycarbonate LED light bars with an integrated connector for direct linking and continuous linear effect
- Available in three sizes and three power levels
- For each size and power variant, available in 3000K and 4000K versions



W	K	LUMEN APPARECCHIO lm	LUMEN SORGENTE lm	MISURE	VARIANTE	CODICE	EAN		
5	3000	450	500	120°	1	LD4BAR03052	8031453032579	1/25	
5	4000	500	550	120°	1	LD4BAR03053	8031453032586	1/25	
9	3000	810	900	120°	2	LD4BAR06092	8031453032593	1/25	
9	4000	900	1000	120°	2	LD4BAR06093	8031453032609	1/25	
18	3000	1650	1800	120°	3	LD4BAR12182	8031453032616	1/25	
18	4000	1800	2000	120°	3	LD4BAR12183	8031453032623	1/25	

YGS - Switch Fisico

Reglette Led CCT con selettore / CCT Led reglette with selector

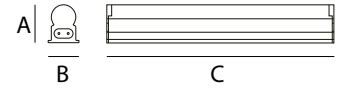

Dimensioni	A	B	C
1	34	23	300
2	34	23	572
3	34	23	880
4	34	23	1178
5	34	23	1478

Compreso cavo di alimentazione da 1,5m e cavo di interconnessione da 15cm.

Including 1,5m power cable and 15cm interconnection cable.

Barre di potenze differenti possono essere connesse tra loro per una potenza complessiva di 220W.

Bars of different wattages can be connected to each other. Total power must not exceed 220W.

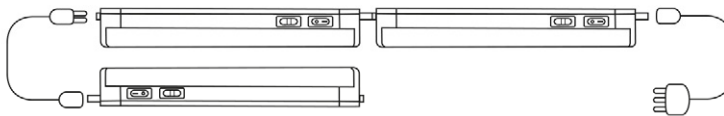

- Gamma completa di reglette a led in policarbonato con interruttore per sostituzione delle tradizionali reglette T5
- Disponibili in cinque potenze e misure
- CCT selezionabile

- Complete range of polycarbonate LED reglette with switch to replace conventional T5 reglette
- Available in five power outputs and sizes
- Selectable CCT



W	K	LUMEN APPARECCHIO lm	LUMEN SORGENTE lm	MISURE	VARIANTE	CODICE	EAN		
5	<input type="checkbox"/> 3000 <input type="checkbox"/> 4000 <input type="checkbox"/> 6500	570	630	120° 1	-	YGS05KB	8031453032098	1/25	
9	<input type="checkbox"/> 3000 <input type="checkbox"/> 4000 <input type="checkbox"/> 6500	1000	1150	120° 2	-	YGS09KB	8031453032104	1/25	
14	<input type="checkbox"/> 3000 <input type="checkbox"/> 4000 <input type="checkbox"/> 6500	1600	1800	120° 3	-	YGS14KB	8031453032111	1/25	
18	<input type="checkbox"/> 3000 <input type="checkbox"/> 4000 <input type="checkbox"/> 6500	2100	2300	120° 4	-	YGS18KB	8031453032128	1/25	
22	<input type="checkbox"/> 3000 <input type="checkbox"/> 4000 <input type="checkbox"/> 6500	2600	2850	120° 5	-	YGS22KB	8031453032135	1/25	

YGQ - Switch Fisico

NEW

BTL CATEGORIA SCONTO 23

Reglette Led CCT con selettore / CCT Led reglette with selector



Dimensioni	A	B	C
1	30,5	23	300
2	30,5	23	572
3	30,5	23	880
4	30,5	23	1178
5	30,5	23	1478

Compreso cavo di alimentazione da 1,5m e cavo di interconnessione da 15cm.

Including 1,5m power cable and 15cm interconnection cable.

Barre di potenze differenti possono essere connesse tra loro per una potenza complessiva di 220W.

Bars of different wattages can be connected to each other. Total power must not exceed 220W.

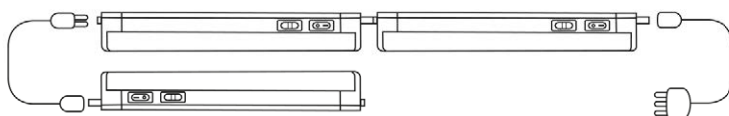

- Gamma completa di reglette a led in policarbonato con interruttore per sostituzione delle tradizionali reglette T5
- Disponibili in cinque potenze e misure
- CCT selezionabile

- Complete range of polycarbonate LED reglette with switch to replace conventional T5 reglette
- Available in five power outputs and sizes
- Selectable CCT



W	K	LUMEN APPARECCHIO lm	LUMEN SORGENTE lm	MISURE	VARIANTE	CODICE	EAN		
5	<input type="checkbox"/> 3000 <input type="checkbox"/> 4000 <input type="checkbox"/> 6500	500	550	120° 1	-	YGQ05KB	8031453032906	1/25	
9	<input type="checkbox"/> 3000 <input type="checkbox"/> 4000 <input type="checkbox"/> 6500	900	1000	120° 2	-	YGQ09KB	8031453032913	1/25	
14	<input type="checkbox"/> 3000 <input type="checkbox"/> 4000 <input type="checkbox"/> 6500	1400	1550	120° 3	-	YGQ14KB	8031453032920	1/25	
18	<input type="checkbox"/> 3000 <input type="checkbox"/> 4000 <input type="checkbox"/> 6500	1800	2000	120° 4	-	YGQ18KB	8031453032937	1/25	
22	<input type="checkbox"/> 3000 <input type="checkbox"/> 4000 <input type="checkbox"/> 6500	2200	2450	120° 5	-	YGQ22KB	8031453032944	1/25	

YGR - Switch Fisico

NEW

BTL CATEGORIA SCONTO 23

Reglette CCT regolabile / CCT adjustable reglette

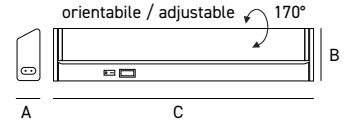

Dimensioni	A	B	C
1	24	61	297
2	24	61	545

Compreso cavo di alimentazione da 1,5m e cavo di interconnessione da 15cm.

Including 1,5m power cable and 15cm interconnection cable.

Barre di potenze differenti possono essere connesse tra loro per una potenza complessiva di 220W.

Bars of different wattages can be connected to each other. Total power must not exceed 220W.

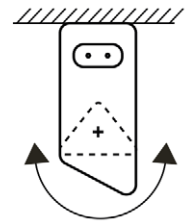
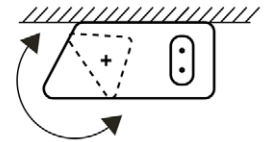
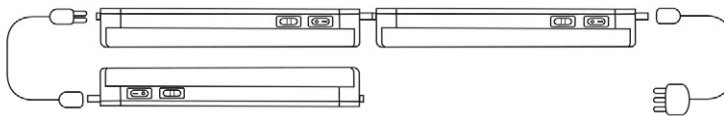

- _ Gamma di reglette a led in policarbonato con connettore integrato per giunzione diretta
- _ Disponibili in due potenze e misure
- _ Diffusore orientabile
- _ CCT selezionabile

- _ Range of polycarbonate LED battens with integrated connector for direct joining
- _ Available in two power levels and sizes
- _ Adjustable diffuser
- _ Selectable CCT



W	K	LUMEN APPARECCHIO lm	LUMEN SORGENTE lm	MISURE	VARIANTE	CODICE	EAN		
4	3000	400	550	120°	1	-	YGR04K	8031453033736	1/25
	4000								
	6500								
8	3000	900	1100	120°	2	-	YGR08K	8031453033743	1/25
	4000								
	6500								

YGB NEW

BTL CATEGORIA SCONTO 24

Sottopensile CCT / CCT cabinet light

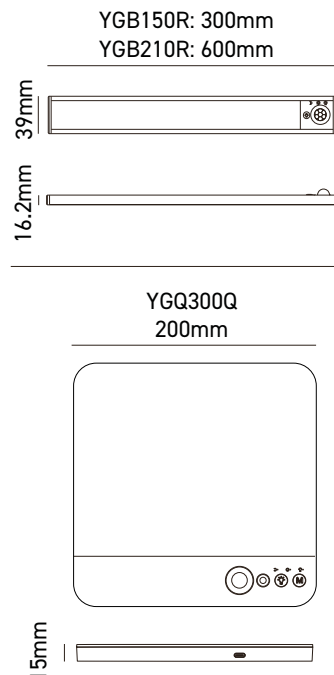

- Sottopensile ricaricabile con sensore di presenza
- Attacco magnetico diretto o tramite piastra magnetica adesiva in dotazione
- Tre modalità di funzionamento: rilevamento di presenza e luminosità ambientale, rilevamento di presenza, sempre acceso
- Intensità luminosa regolabile senza soluzione di continuità
- Batteria al litio
- Cavo di ricarica USB-C da 1m incluso

- Rechargeable cabinet light with presence sensor
- Direct magnetic attachment or via included adhesive magnetic plate
- Three operating modes: presence and ambient light detection, presence detection only, always on
- Stepless dimmable light intensity
- Lithium battery
- 1m USB-C charging cable included

IP 20
III
20.000h
0°+40°
CCT
PIR
⚠

W	K	LUMEN SORGENTE lm	◀▶	VARIANTE	CODICE	EAN	📦	€ IVA ESCLUSA
1,5	<input type="checkbox"/> 3000 <input type="checkbox"/> 4000 <input type="checkbox"/> 6500	150	120°	-	YGB150R	8031453034504	1/65	
2,2	<input type="checkbox"/> 3000 <input type="checkbox"/> 4000 <input type="checkbox"/> 6500	300	120°	-	YGB210R	8031453034511	1/40	
3,5	<input type="checkbox"/> 3000 <input type="checkbox"/> 4000 <input type="checkbox"/> 6500	400	120°	-	YGB300Q	8031453034528	1/50	





SHOT
BOT LIGHTING

TECNICO / PLAFONIERE STAGNE
TECHNICAL / TRI-PROOF



PLAFONIERA STAGNA VUOTA PER TUBI LED

EMPTY SILM LED TRI-PROOF FOR LED TUBES

BTL CATEGORIA SCONTO 24

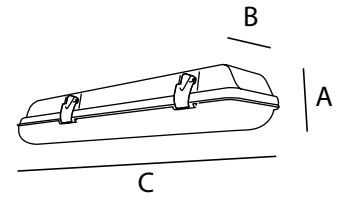

Dimensioni	A	B	C
1	76,5	65	660
2	76,5	65	1262
3	76,5	65	1562
4	76,5	95	660
5	76,5	95	1262
6	76,5	95	1562

- _ Plafoniera stagna in materiale termoplastico ad alta resistenza meccanica con schermo in policarbonato, da utilizzare esclusivamente con tubi a Led
- _ Fornita senza tubi
- _ Disponibili in 6 diverse misure

- _ *Triproof ceiling light in thermoplastic material with high mechanical resistance, with polycarbonate screen, to be used exclusively with LED tubes*
- _ *Without tubes*
- _ *Available in 6 different sizes*



VARIANTE	MISURE	CODICE	EAN	
PER UN TUBO / FOR ONE TUBE	1	LDOWPF106	8031453025502	1/15
PER UN TUBO / FOR ONE TUBE	2	LDOWPF112	8031453025519	1/15
PER UN TUBO / FOR ONE TUBE	3	LDOWPF115	8031453025526	1/15
PER DUE TUBI / FOR TWO TUBES	4	LDOWPF206	8031453025533	1/10
PER DUE TUBI / FOR TWO TUBES	5	LDOWPF212	8031453025540	1/10
PER DUE TUBI / FOR TWO TUBES	6	LDOWPF215	8031453025557	1/10

PLAFONIERA STAGNA A LED SLIM

SLIM LED TRI-PROOF

BTL CATEGORIA SCONTO 24

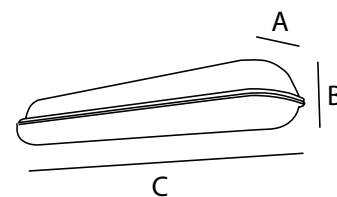

Dimensioni	A	B	C
1	78	80	650
2	78	80	1250
3	78	80	1550

- Plafoniera stagna in policarbonato e ganci in acciaio inox
- Design slim
- Alta efficienza fino a 140 lm/W
- Lunga durata grazie ai suoi materiali resistenti all'acqua, polvere e corrosione

- Tri-proof in polycarbonate with stainless steel hooks
- Slim design
- High efficiency up to 140 lm/W
- Resistant to water, dust and corrosion



W	K	LUMEN APPARECCHIO lm	LUMEN SORGENTE lm		MISURE	VARIANTE	CODICE	EAN		
18	<input type="checkbox"/> 4000	2500	2700	120°	1	ON/OFF	LD2WPF183	8031453024482	1/8	
30	<input type="checkbox"/> 4000	4200	4500	120°	2	ON/OFF	LD2WPF303	8031453024499	1/6	
45	<input type="checkbox"/> 4000	6600	7200	120°	3	ON/OFF	LD2WPF453	8031453026509	1/6	
65	<input type="checkbox"/> 4000	9100	9800	120°	3	ON/OFF	LD2WPF653	8031453024512	1/6	
81	<input type="checkbox"/> 4000	11000	12400	120°	3	ON/OFF	LD2WPF813	8031453026523	1/6	

PLAFONIERA STAGNA A LED SLIM - PASSANTE

BTL CATEGORIA SCONTO 24

SLIM LED TRI-PROOF - PASS THROUGH

AGGIORNATO

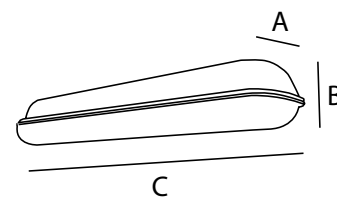

Dimensioni	A	B	C
1	78	80	1250
2	78	80	1550

- _ Plafoniera stagna in policarbonato e ganci in acciaio inox
- _ Design slim
- _ Alta efficienza fino a 140 lm/W
- _ Lunga durata grazie ai suoi materiali resistenti all'acqua, polvere e corrosione
- _ Collegamento passante per collegare tra di loro fino a 33 pezzi di LD2WPF303L o 22 pezzi di LD2WPF453L per un totale complessivo di 1000W

- _ Tri-proof in polycarbonate with stainless steel hooks
- _ Slim design
- _ High efficiency up to 140 lm/W
- _ Resistant to water, dust and corrosion
- _ Pass through connection in order to connect up to 33 pieces of LD2WPF303L or 22 pieces of LD2WPF453L for a total of 1000W



W	K	LUMEN APPARECCHIO lm	LUMEN SORGENTE lm	MISURE	VARIANTE	CODICE	EAN			
30	4000	4200	4500	120°	PASSANTE / PASS-THROUGH	LD2WPF303L	8031453024529	1/6		
NEW	45	6600	7200	120°	PASSANTE / PASS-THROUGH	LD2WPF453L	8031453031732	1/6		

PLAFONIERA STAGNA A LED SLIM - EMERGENZA

BTL CATEGORIA SCONTO 24

SLIM LED TRI-PROOF - EMERGENCY

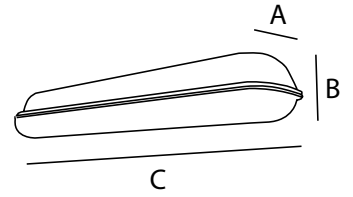

Dimensioni	A	B	C
1	78	80	1250
2	78	80	1550

- _ Plafoniera stagna in policarbonato e ganci in acciaio inox
- _ Design slim
- _ Alta efficienza fino a 140 lm/W
- _ Lunga durata grazie ai suoi materiali resistenti all'acqua, polvere e corrosione
- _ Autonomia in emergenza 3h
- _ Tempo di ricarica 24h
- _ Lumen in emergenza 300lm

- _ Tri-proof in polycarbonate with stainless steel hooks
- _ Slim design
- _ High efficiency up to 140 lm/W
- _ Resistant to water, dust and corrosion
- _ Emergency autonomy period 3h
- _ Charging time 24h
- _ Emergency lumen output 300lm



W	K	LUMEN APPARECCHIO lm	LUMEN SORGENTE lm	MISURE	VARIANTE	CODICE	EAN			
30	4000	4200	4500	120°	1	EMERGENZA / EMERGENCY	LD2WPF303E	8031453024543	1/6	
45	4000	6700	7200	120°	2	EMERGENZA / EMERGENCY	LD2WPF453E	8031453026516	1/6	

PLAFONIERA STAGNA A LED SLIM - RADAR

SLIM LED TRI-PROOF - RADAR

BTL CATEGORIA SCONTO 24

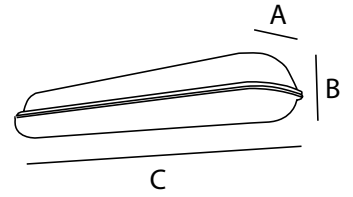
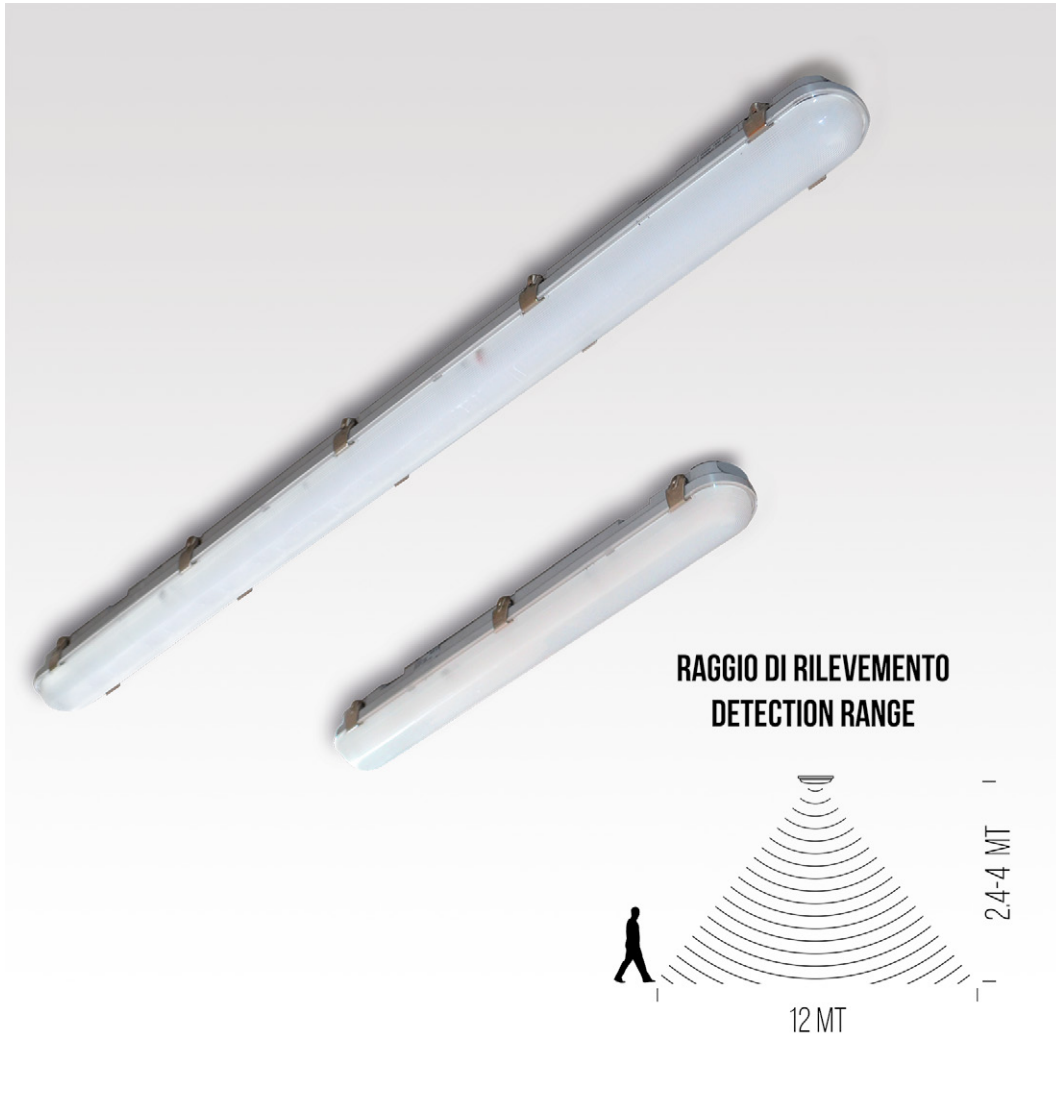

Dimensioni	A	B	C
1	78	80	650
2	78	80	1250
3	78	80	1550

- Plafoniera stagna in policarbonato e ganci in acciaio inox
- Design slim
- Alta efficienza fino a 140 lm/W
- Lunga durata grazie ai suoi materiali resistenti all'acqua, polvere e corrosione
- Sensore microonde programmabile mediante dip-switch (sensibilità, livello di luce ambiente, tempo di accensione)

- Tri-proof in polycarbonate with stainless steel hooks
- Slim design
- High efficiency up to 140 lm/W
- Resistant to water, dust and corrosion
- Option version with microwave sensor programmable by dip-switch (sensitivity, ambient light level, light switch-on time)



W	K	LUMEN APPARECCHIO lm	LUMEN SORGENTE lm		MISURE	VARIANTE	CODICE	EAN		
18	<input type="checkbox"/> 4000	2500	2700	120°	1	SENSORE A MICROONDE / MICROWAVE SENSOR	LD2WPF183MW	8031453024680	1/8	
30	<input type="checkbox"/> 4000	4200	4500	120°	2	SENSORE A MICROONDE / MICROWAVE SENSOR	LD2WPF303MW	8031453024574	1/6	
45	<input type="checkbox"/> 4000	6600	7200	120°	3	SENSORE A MICROONDE / MICROWAVE SENSOR	LD2WPF453MW	8031453027247	1/6	
65	<input type="checkbox"/> 4000	9100	9800	120°	3	SENSORE A MICROONDE / MICROWAVE SENSOR	LD2WPF653MW	8031453024598	1/6	
81	<input type="checkbox"/> 4000	11000	12400	120°	3	SENSORE A MICROONDE / MICROWAVE SENSOR	LD2WPF813MW	8031453027254	1/6	

PLAFONIERA STAGNA A LED SLIM LD3

LD3 SLIM LED TRI-PROOF

BTL CATEGORIA SCONTO 24

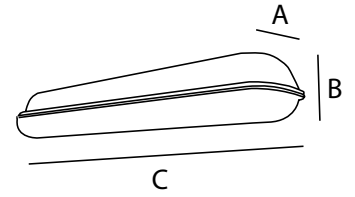

Dimensioni	A	B	C
1	66	68	600
2	66	68	1200
3	66	68	1500

- Plafoniera stagna sigillata in policarbonato
- Design slim
- Alta efficienza fino a 140 lm/W
- Lunga durata grazie ai suoi materiali resistenti all'acqua, polvere e corrosione

- Sealed tri-proof in polycarbonate
- Slim design
- High efficiency up to 140 lm/W
- Resistant to water, dust and corrosion



W	K	LUMEN APPARECCHIO lm	LUMEN SORGENTE lm	MISURE	VARIANTE	CODICE	EAN		
18	4000	2100	2500	120°	1	LD3WPF183	8031453026455	1/12	
36	6500	4300	5000	120°	2	LD3WPF361	8031453026479	1/12	
36	4000	4300	5000	120°	2	LD3WPF363	8031453026462	1/12	
52	4000	6200	7200	120°	3	LD3WPF523	8031453026486	1/9	
52	6500	6200	7200	120°	3	LD3WPF521	8031453026493	1/9	





SHOT
BOT LIGHTING

TECNICO / TECHNICAL
HIGH BAY



HIGH BAY LED 150

BTL CATEGORIA SCONTO 24

Proiettore High bay LED 150W / High power Led high bay 150W

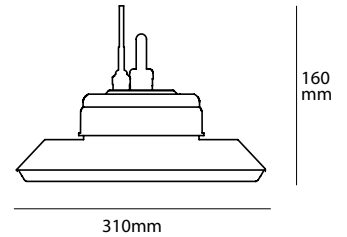

- _ Proiettore per applicazioni industriali ideale per la sostituzione degli apparecchi tradizionali a scarica da 250W e 400W in ambienti come magazzini, capannoni o grandi superfici in genere.
- _ Corpo in alluminio verniciato di colore nero
- _ Alta efficienza 150 lm/W
- _ Anello per montaggio a sospensione

- _ Floodlight for industrial applications, ideal for replacing traditional 250W and 400W high pressure discharge lamps in large surface environments such as warehouses, industrial sheds.
- _ Painted die-cast aluminium body
- _ High efficiency 150 lm/W
- _ Ring for suspension mounting



W	K	LUMEN APPARECCHIO lm	LUMEN SORGENTE lm		VARIANTE	CODICE	EAN		
150	4000	21000	22500	90°	-	LD3HB150N	8031453026097	1	

HIGH BAY LED 200

BTL CATEGORIA SCONTO 24

Proiettore High bay LED 200W / High power Led high bay 200W

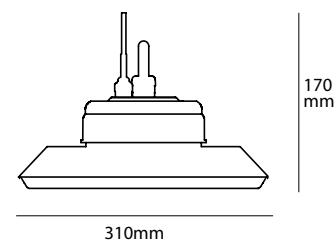

- _ Proiettore per applicazioni industriali ideale per la sostituzione degli apparecchi tradizionali a scarica da 250W e 400W in ambienti come magazzini, capannoni o grandi superfici in genere
- _ Corpo in alluminio verniciato di colore nero
- _ Alta efficienza 150 lm/W
- _ Anello per montaggio a sospensione

- _ Floodlight for industrial applications, ideal for replacing traditional 250W and 400W high pressure discharge lamps in large surface environments such as warehouses, industrial sheds.
- _ Painted die-cast aluminium body
- _ High efficiency 150 lm/W
- _ Ring for suspension mounting



W	K	LUMEN APPARECCHIO lm	LUMEN SORGENTE lm		VARIANTE	CODICE	EAN		
200	4000	28000	31000	90°	-	LD3HB200N	8031453026103	1	

SS DOB HIGH BAY

Proiettore High Bay Led DOB / DOB Led High Bay

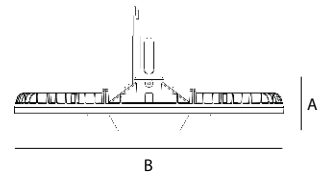

Dimensioni	A	B
1	83	240
2	83	285
3	83	315

- _ Proiettore per applicazioni industriali ideale per la sostituzione degli apparecchi tradizionali a scarica in ambienti come magazzini, capannoni o grandi superfici in genere
- _ Corpo in alluminio verniciato bianco RAL9003 (solo nella versione 100W) o grigio RAL9007
- _ Alta efficienza fino a 130 lm/W
- _ High bay a LED con tecnologia Driver On Board (DOB)
- _ Protezione dalle sovratensioni di 4kV linea-linea
- _ Protezione dalle sovratensioni di 6kV linea-terra

- _ Floodlight for industrial applications, ideal for replacing traditional high pressure discharge lamps in large surface environments such as warehouses, industrial sheds.
- _ White RAL9003 (only on 100W version) or gray RAL9007 aluminium body
- _ High efficiency up to 130 lm/W
- _ LED high bay with 'Driver On Board' (DOB) technology
- _ Overvoltage protection of 4kV line-line
- _ Overvoltage protection of 6kV line-earth



W	K	LUMEN APPARECCHIO lm	LUMEN SORGENTE lm	MISURE	VARIANTE	CODICE	EAN			
100	4000	13000	13400	110°	1	BIANCO / WHITE	LD4HB100B	8031453032173	1	A T G E
100	4000	13000	13400	110°	1	ANTRACITE / ANTHRACITE	LD4HB100G	8031453032180	1	A T G E
150	4000	19500	20000	110°	2	ANTRACITE / ANTHRACITE	LD4HB150G	8031453032197	1	A T G E
200	4000	26000	26300	110°	3	ANTRACITE / ANTHRACITE	LD4HB200G	8031453032203	1	A T G E
STAFFA PER SS DOB HIGH BAY/ BRACKET FOR SS DOB HIGH BAY						LD4HBKIT	8031453032210	1		







SHOT
BOT LIGHTING

TECNICO / PROIETTORI
TECHNICAL / FLOODLIGHTS



ORLANDO 10

BTL CATEGORIA SCONTO 24

Proiettore a Led slim / Slim Led floodlight

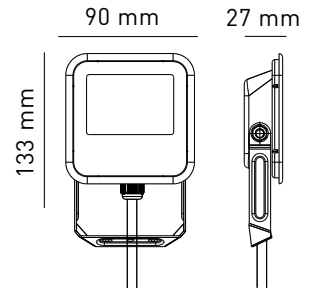

- _ Proiettore a LED slim con tecnologia 'Driver On Board' (DOB)
- _ Alta efficienza 110 lm/W
- _ Corpo in alluminio verniciato e diffusore in vetro temperato
- _ Colore bianco RAL 9016 o grigio RAL 7024

- _ Slim LED floodlight with 'Driver On Board' (DOB) technology
- _ High efficiency 110 lm/W
- _ Painted aluminum body with tempered glass diffuser
- _ White RAL 9016 or grey RAL 7024 colors



W	K	LUMEN APPARECCHIO lm	LUMEN SORGENTE lm		VARIANTE	CODICE	EAN		
10	3000	1000	1100	120°	BIANCO / WHITE	ORLANDO10B	8031453023300	1/30	
10	4000	1100	1200	120°	GRIGIO GRAFITE / GRAPHITE GREY	ORLANDO10G	8031453023256	1/30	



ORLANDO 10

ORLANDO 20

BTL CATEGORIA SCONTO 24

Proiettore a Led slim / Slim Led floodlight

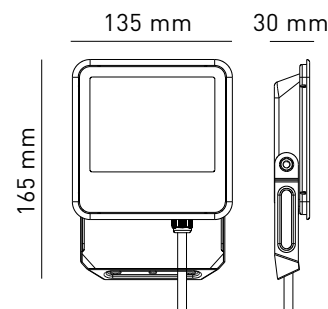

- _ Proiettore a LED slim con tecnologia 'Driver On Board' (DOB)
- _ Alta efficienza 110 lm/W
- _ Corpo in alluminio verniciato e diffusore in vetro temperato
- _ Colore bianco RAL 9016 o grigio RAL 7024

- _ Slim LED floodlight with 'Driver On Board' (DOB) technology
- _ High efficiency 110 lm/W
- _ Painted aluminum body with tempered glass diffuser
- _ White RAL 9016 or grey RAL 7024 colors



W	K	LUMEN APPARECCHIO lm	LUMEN SORGENTE lm	Beam Angle	VARIANTE	CODICE	EAN	Box	Energy Efficiency
20	3000	2100	2500	120°	BIANCO / WHITE	ORLANDO20B	8031453023317	1/20	A++ E
20	4000	2300	2650	120°	BIANCO / WHITE	ORLANDO20BN	8031453024741	1/20	A++ E
20	4000	2300	2650	120°	GRIGIO GRAFITE / GRAPHITE GREY	ORLANDO20G	8031453023263	1/20	A++ E
20	6500	2300	2650	120°	GRIGIO GRAFITE / GRAPHITE GREY	ORLANDO20GD	8031453024758	1/20	A++ E

ORLANDO 20 PIR

Proiettore a Led slim / Slim Led floodlight

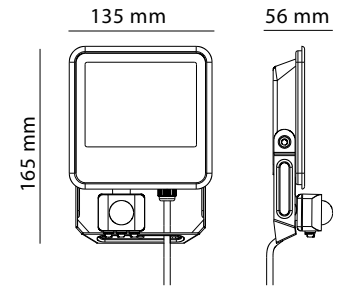

- _ Proiettore a LED slim con tecnologia 'Driver On Board' (DOB)
- _ Alta efficienza 110 lm/W
- _ Corpo in alluminio verniciato e diffusore in vetro temperato
- _ Colore grigio RAL 7024
- _ Sensore programmabile (sensibilità al movimento, livello di luce ambiente, durata)

- _ Slim LED floodlight with 'Driver On Board' (DOB) technology
- _ High efficiency 110 lm/W
- _ Painted aluminum body with tempered glass diffuser
- _ Grey RAL 7024 color
- _ Programmable sensor (movement sensitivity, ambient light level, duration)



W	K	LUMEN APPARECCHIO lm	LUMEN SORGENTE lm		VARIANTE	CODICE	EAN		
20	4000	2300	2650	120°	GRIGIO GRAFITE SENSORE PIR / GRAPHITE GREY PIR SENSOR	ORLANDO20GIR	8031453023355	1/20	A++ E

ORLANDO 30

BTL CATEGORIA SCONTO 24

Proiettore a Led slim / Slim Led floodlight

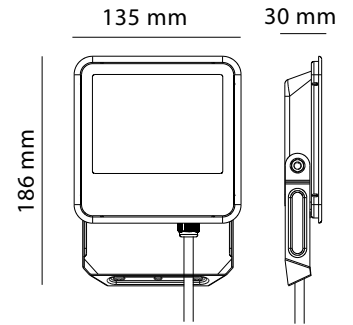

- _ Proiettore a LED slim con tecnologia 'Driver On Board' (DOB)
- _ Alta efficienza 110 lm/W
- _ Corpo in alluminio verniciato e diffusore in vetro temperato
- _ Colore bianco RAL 9016 o grigio RAL 7024

- _ Slim LED floodlight with 'Driver On Board' (DOB) technology
- _ High efficiency 110 lm/W
- _ Painted aluminum body with tempered glass diffuser
- _ White RAL 9016 or grey RAL 7024 colors



W	K	LUMEN APPARECCHIO lm	LUMEN SORGENTE lm		VARIANTE	CODICE	EAN		
30	3000	3150	3550	120°	<input type="checkbox"/> BIANCO / WHITE	ORLANDO30B	8031453023324	1/20	
30	<input type="checkbox"/> 4000	3450	3750	120°	<input checked="" type="checkbox"/> GRIGIO GRAFITE / GRAPHITE GREY	ORLANDO30G	8031453023270	1/20	
30	<input type="checkbox"/> 4000	3450	3750	120°	<input type="checkbox"/> BIANCO / WHITE	ORLANDO30BN	8031453024765	1/20	
30	6500	3450	3750	120°	<input checked="" type="checkbox"/> GRIGIO GRAFITE / GRAPHITE GREY	ORLANDO30GD	8031453024772	1/20	

ORLANDO 30 PIR

Proiettore a Led slim / Slim Led floodlight

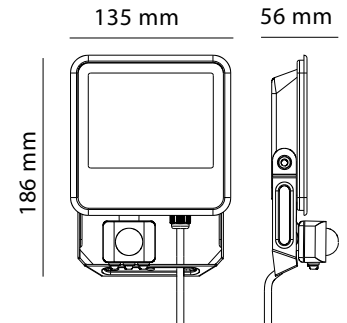

- _ Proiettore a LED slim con tecnologia 'Driver On Board' (DOB)
- _ Alta efficienza 110 lm/W
- _ Corpo in alluminio verniciato e diffusore in vetro temperato
- _ Colore grigio RAL 7024
- _ Sensore programmabile (sensibilità al movimento, livello di luce ambiente, durata)

- _ Slim LED floodlight with 'Driver On Board' (DOB) technology
- _ High efficiency 110 lm/W
- _ Painted aluminum body with tempered glass diffuser
- _ Grey RAL 7024 color
- _ Programmable sensor (movement sensitivity, ambient light level, duration)



W	K	LUMEN APPARECCHIO lm	LUMEN SORGENTE lm		VARIANTE	CODICE	EAN		
30	4000	3450	3750	120°	GRIGIO GRAFITE SENSORE PIR / GRAPHITE GREY PIR SENSOR	ORLANDO30GIR	8031453023362	1/20	A+ E

ORLANDO 50

BTL CATEGORIA SCONTO 24

Proiettore a Led slim / Slim Led floodlight

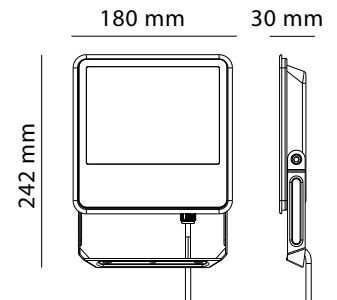

- _ Proiettore a LED slim con tecnologia 'Driver On Board' (DOB)
- _ Alta efficienza 110 lm/W
- _ Corpo in alluminio verniciato e diffusore in vetro temperato
- _ Colore bianco RAL 9016 o grigio RAL 7024

- _ Slim LED floodlight with 'Driver On Board' (DOB) technology
- _ High efficiency 110 lm/W
- _ Painted aluminum body with tempered glass diffuser
- _ White RAL 9016 or grey RAL 7024 colors



W	K	LUMEN APPARECCHIO lm	LUMEN SORGENTE lm		VARIANTE	CODICE	EAN			
50		3000	5500	6350	120°	BIANCO / WHITE	ORLANDO50B	8031453023331	1/10	
50		4000	6000	6700	120°	BIANCO / WHITE	ORLANDO50BN	8031453024789	1/10	
50		4000	6000	6700	120°	GRIGIO GRAFITE / GRAPHITE GREY	ORLANDO50G	8031453023287	1/10	
50		6500	6000	6700	120°	GRIGIO GRAFITE / GRAPHITE GREY	ORLANDO50GD	8031453024796	1/10	

ORLANDO 50 PIR

Proiettore a Led slim / Slim Led floodlight

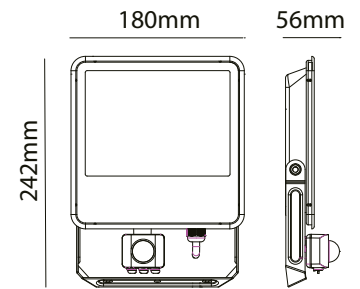

- _ Proiettore a LED slim con tecnologia 'Driver On Board' (DOB)
- _ Alta efficienza 110lm/W
- _ Corpo in alluminio verniciato e diffusore in vetro temperato
- _ Colore grigio RAL 7024
- _ Sensore programmabile (sensibilità al movimento, livello di luce ambiente, durata)

- _ Slim LED floodlight with 'Driver On Board' (DOB) technology
- _ High efficiency 110 lm/W
- _ Painted aluminum body with tempered glass diffuser
- _ Grey RAL 7024 color
- _ Programmable sensor (movement sensitivity, ambient light level, duration)



W	K	LUMEN APPARECCHIO lm	LUMEN SORGENTE lm		VARIANTE	CODICE	EAN		
50	4000	6000	6500	120°	GRIGIO GRAFITE / GRAPHITE GREY	ORLANDO50GIR	8031453031794	1/10	A t G E

ORLANDO 90

BTL CATEGORIA SCONTO 24

Proiettore a Led slim / Slim Led floodlight

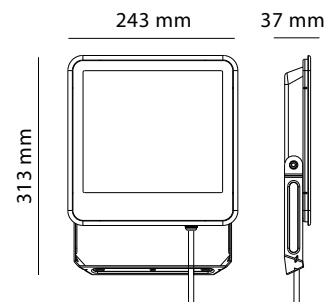

- _ Proiettore a LED slim con tecnologia 'Driver On Board' (DOB)
- _ Alta efficienza 110 lm/W
- _ Corpo in alluminio verniciato e diffusore in vetro temperato
- _ Colore bianco RAL 9016 o grigio RAL 7024
- _ Valvola di sfogo per evitare la formazione di condensa all'interno del proiettore

- _ Slim LED floodlight with 'Driver On Board' (DOB) technology
- _ High efficiency 110 lm/W
- _ Painted aluminum body with tempered glass diffuser
- _ White RAL 9016 or grey RAL 7024 colors
- _ External vent to avoid condensation inside the projector



W	K	LUMEN APPARECCHIO lm	LUMEN SORGENTE lm		VARIANTE	CODICE	EAN		
90		3000	9900	120°	<input type="checkbox"/> BIANCO / WHITE	ORLANDO90B	8031453023348	1/5	
90	<input type="checkbox"/>	4000	10800	120°	<input type="checkbox"/> BIANCO / WHITE	ORLANDO90BN	8031453024802	1/5	
90	<input type="checkbox"/>	4000	10800	120°	<input checked="" type="checkbox"/> GRIGIO GRAFITE / GRAPHITE GREY	ORLANDO90G	8031453023294	1/5	
90		6500	10800	120°	<input checked="" type="checkbox"/> GRIGIO GRAFITE / GRAPHITE GREY	ORLANDO90GD	8031453024819	1/5	



ORLANDO 90

ORLANDO 150

BTL CATEGORIA SCONTO 24

Proiettore a Led slim / Slim Led floodlight

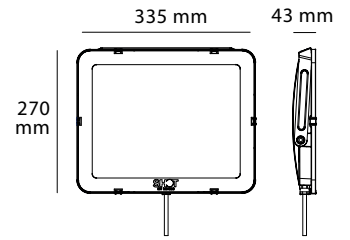

- _ Proiettore a LED slim con tecnologia 'Driver On Board' (DOB)
- _ Alta efficienza 110 lm/W
- _ Corpo in alluminio verniciato e diffusore in vetro temperato
- _ Colore grigio RAL 7024
- _ Valvola integrata per espulsione della condensa

- _ Slim LED floodlight with 'Driver On Board' (DOB) technology
- _ High efficiency 110 lm/W
- _ Painted aluminum body with tempered glass diffuser
- _ Grey RAL 7024 color
- _ Integrated valve in order to avoid condensation



W	K	LUMEN APPARECCHIO lm	LUMEN SORGENTE lm		VARIANTE	CODICE	EAN			
150	<input type="checkbox"/> 4000	16500	18300	120°	<input checked="" type="checkbox"/> GRIGIO GRAFITE / GRAPHITE GREY	ORLANDO150G	8031453025564	1/5		

ORLANDO 200

BTL CATEGORIA SCONTO 24

Proiettore a Led slim / Slim Led floodlight

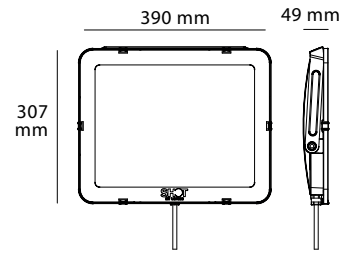

- _ Proiettore a LED slim con tecnologia 'Driver On Board' (DOB)
- _ Alta efficienza 110 lm/W
- _ Corpo in alluminio verniciato e diffusore in vetro temperato
- _ Colore grigio RAL 7024
- _ Valvola integrata per espulsione della condensa

- _ Slim LED floodlight with 'Driver On Board' (DOB) technology
- _ High efficiency 110 lm/W
- _ Painted aluminum body with tempered glass diffuser
- _ Grey RAL 7024 color
- _ Integrated valve in order to avoid condensation



W	K	LUMEN APPARECCHIO lm	LUMEN SORGENTE lm		VARIANTE	CODICE	EAN		
200	<input type="checkbox"/> 4000	22000	24500	120°	<input checked="" type="checkbox"/> GRIGIO GRAFITE / GRAPHITE GREY	ORLANDO200G	8031453025571	1	

Proiettore a Led professionale / Professional Led floodlight

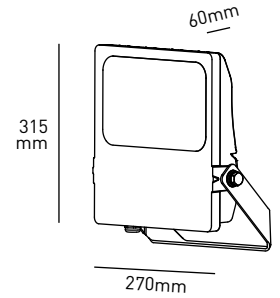

Accessorio testa per palo
Pole adaptor

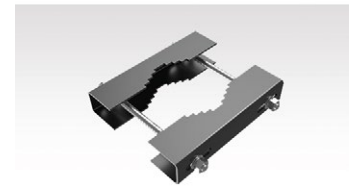

Accessorio morsa per palo
Clamp bracket

- _ Proiettore a LED professionale
- _ Alta efficienza 150 lm/W
- _ Corpo in alluminio pressofuso verniciato e diffusore in vetro temperato
- _ Disponibile con cinque differenti fasci: Asimmetrico 26°x60° e 50°x120°, Concentrato 25° e 60°, Flood 120°
- _ Valvola di sfogo per evitare la formazione di condensa all'interno del proiettore
- _ Indice di protezione IP66
- _ Protezione dalle sovratensioni di 6kV linea-linea
- _ Protezione dalle sovratensioni di 6kV linea-terra
- _ Colore RAL9006

- _ Professional LED projector
- _ High efficiency 150 lm/W
- _ Body in painted die-cast aluminum and diffuser in tempered glass
- _ Available with five different beams, Asymmetrical 26°x60° and 50°x120°, Concentrated 25° and 60° and Flood 120°
- _ External vent to avoid condensation inside the projector
- _ Protection index IP66
- _ Overvoltage protection of 6kV line-line
- _ Overvoltage protection of 6kV line-earth
- _ RAL9006 color



	W	K	LUMEN APPARECCHIO lm	LUMEN SORGENTE lm		VARIANTE	CODICE	EAN		
NEW	100	4000	15000	16600	25°	CONCENTRATO / CONCENTRATED	KYOTO1002G	8031453034139	1	
	100	4000	15000	16600	60°	CONCENTRATO / CONCENTRATED	KYOTO1004G	8031453023416	1	
	100	4000	15000	16600	120°	FLOOD	KYOTO1005G	8031453023423	1	
NEW	100	4000	15000	16600	26x60°	ASIMMETRICO / ASYMMETRIC	KYOTO100NG	8031453034146	1	
	100	4000	15000	16600	50x120°	ASIMMETRICO / ASYMMETRIC	KYOTO100AG	8031453023430	1	
	TESTA PALO PER PROIETTORE - POLE ADAPTOR						KYOTO-TP60	8031453023614	1/10	
	MORSA PALO PER PROIETTORE - CLAMP BRACKET						KYOTO-M150	8031453023621	1/10	

KYOTO 150 AGGIORNATO

BTL CATEGORIA SCONTO 24

Proiettore a Led professionale / Professional Led floodlight

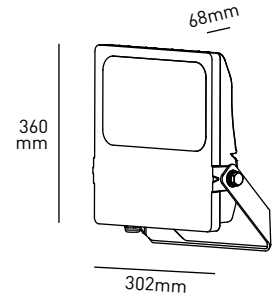

Accessorio testa per palo
Pole adaptor

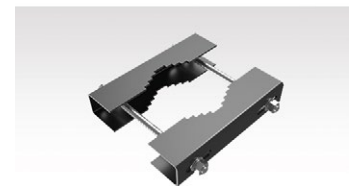

Accessorio morsa per palo
Clamp bracket

- | | |
|---|--|
| <ul style="list-style-type: none"> _ Proiettore a LED professionale _ Alta efficienza 150 lm/W _ Corpo in alluminio pressofuso verniciato e diffusore in vetro temperato _ Disponibile con cinque differenti fasci: Asimmetrico 26°x60° e 50°x120°, Concentrato 25° e 60°, Flood 120° _ Valvola di sfogo per evitare la formazione di condensa all'interno del proiettore _ Indice di protezione IP66 _ Protezione dalle sovratensioni di 6kV linea-linea _ Protezione dalle sovratensioni di 6kV linea-terra _ Colore RAL9006 | <ul style="list-style-type: none"> _ Professional LED projector _ High efficiency 150 lm/W _ Body in painted die-cast aluminum and diffuser in tempered glass _ Available with five different beams, Asymmetrical 26°x60° and 50°x120°, Concentrated 25° and 60° and Flood 120° _ External vent to avoid condensation inside the projector _ Protection index IP66 _ Overvoltage protection of 6kV line-line _ Overvoltage protection of 6kV line-earth _ RAL9006 color |
|---|--|



W	K	LUMEN APPARECCHIO lm	LUMEN SORGENTE lm		VARIANTE	CODICE	EAN			
150	<input type="checkbox"/> 4000	22500	24800	25°	CONCENTRATO / CONCENTRATED	KYOTO1502G	8031453034153	1		NEW
150	<input type="checkbox"/> 4000	22500	24800	60°	CONCENTRATO / CONCENTRATED	KYOTO1504G	8031453023461	1		
150	<input type="checkbox"/> 4000	22500	24800	120°	FLOOD	KYOTO1505G	8031453023478	1		
150	<input type="checkbox"/> 4000	22500	24800	26x60°	ASIMMETRICO / ASYMMETRIC	KYOTO150NG	8031453034160	1		NEW
150	<input type="checkbox"/> 4000	22500	24800	50x120°	ASIMMETRICO / ASYMMETRIC	KYOTO150AG	8031453023485	1		
TESTA PALO PER PROIETTORE - POLE ADAPTOR						KYOTO-TP60	8031453023614	1/10		
MORSA PALO PER PROIETTORE - CLAMP BRACKET						KYOTO-M150	8031453023621	1/10		

Proiettore a Led professionale / Professional Led floodlight

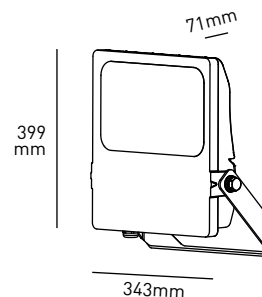

Accessorio testa per palo
Pole adaptor

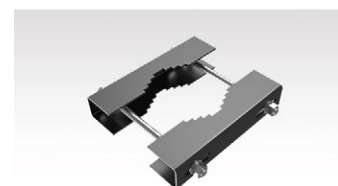

Accessorio morsa per palo
Clamp bracket

- _ Proiettore a LED professionale
- _ Alta efficienza 150 lm/W
- _ Corpo in alluminio pressofuso verniciato e diffusore in vetro temperato
- _ Disponibile con cinque differenti fasci: Asimmetrico 26°x60° e 50°x120°, Concentrato 25° e 60°, Flood 120°
- _ Valvola di sfogo per evitare la formazione di condensa all'interno del proiettore
- _ Indice di protezione IP66
- _ Protezione dalle sovratensioni di 6kV linea-linea
- _ Protezione dalle sovratensioni di 6kV linea-terra
- _ Colore RAL9006

- _ Professional LED projector
- _ High efficiency 150 lm/W
- _ Body in painted die-cast aluminum and diffuser in tempered glass
- _ Available with five different beams, Asymmetrical 26°x60° and 50°x120°, Concentrated 25° and 60° and Flood 120°
- _ External vent to avoid condensation inside the projector
- _ Protection index IP66
- _ Overvoltage protection of 6kV line-line
- _ Overvoltage protection of 6kV line-earth
- _ RAL9006 color

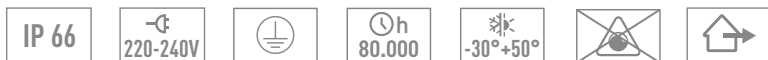

	W	K	LUMEN APPARECCHIO lm	LUMEN SORGENTE lm	Beam	VARIANTE	CODICE	EAN	Box	Energy
NEW	200	4000	30000	33500	25°	CONCENTRATO / CONCENTRATED	KYOTO2002G	8031453034177	1	A T G D
	200	4000	30000	33500	60°	CONCENTRATO / CONCENTRATED	KYOTO2004G	8031453023515	1	A T G D
	200	4000	30000	33500	120°	FLOOD	KYOTO2005G	8031453023522	1	A T G D
NEW	200	4000	30000	33500	26x60°	ASIMMETRICO / ASYMMETRIC	KYOTO200NG	8031453034184	1	A T G D
	200	4000	30000	33500	50x120°	ASIMMETRICO / ASYMMETRIC	KYOTO200AG	8031453023539	1	A T G D
	TESTA PALO PER PROIETTORE - POLE ADAPTOR						KYOTO-TP60	8031453023614	1/10	
	MORSA PALO PER PROIETTORE - CLAMP BRACKET						KYOTO-M300	8031453023638	1/10	

KYOTO 300 AGGIORNATO

BTL CATEGORIA SCONTO 24

Proiettore a Led professionale / Professional Led floodlight

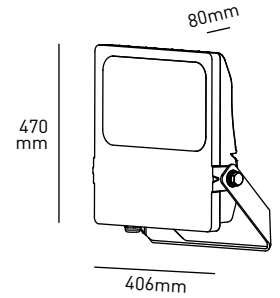

Accessorio testa per palo
Pole adaptor

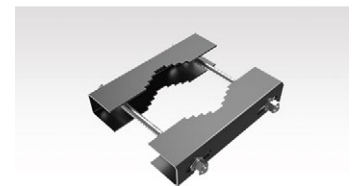

Accessorio morsa per palo
Clamp bracket

- _ Proiettore a LED professionale
 - _ Alta efficienza 150 lm/W
 - _ Corpo in alluminio pressofuso verniciato e diffusore in vetro temperato
 - _ Disponibile con cinque differenti fasci: Asimmetrico 26°x60° e 50°x120°, Concentrato 25° e 60°, Flood 120°
 - _ Valvola di sfogo per evitare la formazione di condensa all'interno del proiettore
 - _ Indice di protezione IP66
 - _ Protezione dalle sovratensioni di 6kV linea-linea
 - _ Protezione dalle sovratensioni di 6kV linea-terra
 - _ Colore RAL9006
- _ Professional LED projector
 - _ High efficiency 150 lm/W
 - _ Body in painted die-cast aluminum and diffuser in tempered glass
 - _ Available with five different beams, Asymmetrical 26°x60° and 50°x120°, Concentrated 25° and 60° and Flood 120°
 - _ External vent to avoid condensation inside the projector
 - _ Protection index IP66
 - _ Overvoltage protection of 6kV line-line
 - _ Overvoltage protection of 6kV line-earth
 - _ RAL9006 color



W	K	LUMEN APPARECCHIO lm	LUMEN SORGENTE lm		VARIANTE	CODICE	EAN			
300	4000	45000	46200	25°	CONCENTRATO / CONCENTRATED	KYOTO3002G	8031453034191	1		NEW
300	4000	45000	46200	60°	CONCENTRATO / CONCENTRATED	KYOTO3004G	8031453023560	1		
300	4000	45000	46200	120°	FLOOD	KYOTO3005G	8031453023577	1		
300	4000	45000	46200	26x60°	ASIMMETRICO / ASYMMETRIC	KYOTO300NG	8031453034207	1		NEW
300	4000	45000	46200	120x50°	ASIMMETRICO / ASYMMETRIC	KYOTO300AG	8031453023584	1		
TESTA PALO PER PROIETTORE - POLE ADAPTOR						KYOTO-TP60	8031453023614	1/10		
MORSA PALO PER PROIETTORE - CLAMP BRACKET						KYOTO-M300	8031453023638	1/10		

Proiettore a Led professionale / Professional Led floodlight

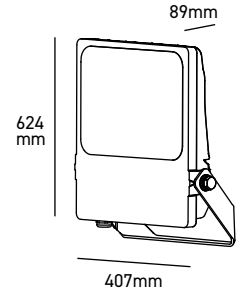

Accessorio testa per palo
Pole adaptor

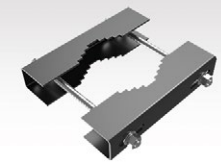

Accessorio morsa per palo
Clamp bracket

- _ Proiettore a LED professionale
- _ Alta efficienza 160 lm/W
- _ Corpo in alluminio pressofuso verniciato e diffusore in vetro temperato
- _ Disponibile con cinque differenti fasci: Asimmetrico 26°x60° e 50°x120°, Concentrato 25° e 60°, Flood 120°
- _ Valvola di sfogo per evitare la formazione di condensa all'interno del proiettore
- _ Indice di protezione IP66
- _ Protezione dalle sovratensioni di 10kV linea-linea
- _ Protezione dalle sovratensioni di 20kV linea-terra
- _ Colore RAL9006

- _ Professional LED projector
- _ High efficiency 160 lm/W
- _ Body in painted die-cast aluminum and diffuser in tempered glass
- _ Available with five different beams, Asymmetrical 26°x60° and 50°x120°, Concentrated 25° and 60° and Flood 120°
- _ External vent to avoid condensation inside the projector
- _ Protection index IP66
- _ Overvoltage protection of 10kV line-line
- _ Overvoltage protection of 20kV line-earth
- _ RAL9006 color



W	K	LUMEN APPARECCHIO lm	LUMEN SORGENTE lm		VARIANTE	CODICE	EAN		
500	<input type="checkbox"/> 4000	77500	80400	25°	CONCENTRATO / CONCENTRATED	KYOTO5002G	8031453034214	1	
500	<input type="checkbox"/> 4000	77500	80400	60°	CONCENTRATO / CONCENTRATED	KYOTO5004G	8031453034412	1	
500	<input type="checkbox"/> 4000	77500	80400	120°	FLOOD	KYOTO5005G	8031453033996	1	
500	<input type="checkbox"/> 4000	77500	80400	26x60°	ASIMMETRICO / ASYMMETRIC	KYOTO500NG	8031453034221	1	
500	<input type="checkbox"/> 4000	77500	80400	120x50°	ASIMMETRICO / ASYMMETRIC	KYOTO500AG	8031453034009	1	
TESTA PALO PER PROIETTORE - POLE ADAPTOR						KYOTO-TP60	8031453023614	1/10	
MORSA PALO PER PROIETTORE - CLAMP BRACKET						KYOTO-M300	8031453023638	1/10	



KYOTO

ATLANTA CCT AGGIORNATO

BTL CATEGORIA SCONTO 24

Proiettore a Led / Led floodlight

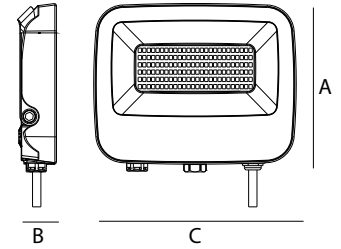

Dimensioni	A	B	C
1	124	32	148
2	137	32	165
3	80	65	50



ATLANTAPIRB
accessorio / accessory
Sensore PIR con telecomando
PIR sensor with remote controller

- _ Corpo in alluminio pressofuso verniciato e diffusore in vetro temperato
- _ Valvola di sfogo per evitare la formazione di condensa all'interno del proiettore
- _ Opzionale ATLANTAPIRB: sensore PIR con telecomando. Aggiornate le modalità di funzionamento rispetto alla versione precedente
- _ CCT selezionabile
- _ Painted aluminum body with tempered glass diffuser
- _ External vent to avoid condensation inside the projector
- _ Optional ATLANTAPIRB: remote controlled PIR sensor. Updated function compared to the previous version
- _ Selectable CCT



W	K	LUMEN APPARECCHIO lm	MISURE	VARIANTE	CODICE	EAN		
30	<input type="checkbox"/> 3000 <input type="checkbox"/> 4000 <input type="checkbox"/> 6000	3300	120° 1	■ NERO / BLACK	ATLANTA30NK	8031453032234	1/24	
50	<input type="checkbox"/> 3000 <input type="checkbox"/> 4000 <input type="checkbox"/> 6000	5500	120° 2	■ NERO / BLACK	ATLANTA50NK	8031453032241	1/20	
ACCESSORIO SENSORE PIR-B / PIR-B SENSOR ACCESSORY					ATLANTAPIRB	8031453032258	1	



FUNZIONAMENTO

I proiettori ATLANTA si possono abbinare al sensore ATLANTAPIRB venduto separatamente, sensore di presenza PIR comandabile con telecomando.

Una volta installato il sensore, tramite l'apposito telecomando si potrà comandare il proiettore ed impostarne modalità e parametri tramite i relativi tasti funzione:

- POWER ON per accendere il proiettore che resterà acceso per 15s e poi si imposterà all'ultima modalità utilizzata
- DAYLIGHT ONLY: disabilita il funzionamento del sensore di movimento, rimane attivo solo il sensore crepuscolare
- SENSOR ON per attivare il sensore di presenza PIR impostato con i parametri dell'ultima modalità utilizzata
- SENSOR OFF per bypassare il sensore PIR e utilizzare il proiettore in modalità ON/OFF
- MODE 1: il proiettore si accende al 100% quando viene rilevato movimento, passato il tempo di accensione prescelto il proiettore si spegnerà finché non verrà rilevato ulteriore movimento
- MODE 2: il proiettore si accende al 100% quando viene rilevato movimento, passato il tempo di accensione prescelto il proiettore rimarrà acceso al 10% dell'emissione luminosa finché non verrà rilevato ulteriore movimento
- MODE 3: il proiettore si accende al 100% quando viene rilevato movimento, passato il tempo di accensione prescelto il proiettore rimarrà acceso al 20% dell'emissione luminosa finché non verrà rilevato ulteriore movimento
- HOLD TIME: per impostare il tempo di accensione del proiettore al 100% nelle diverse modalità
- DAY-LIGHT LEVEL: per impostare il livello di luce ambientale al quale il proiettore si accenderà
- SENSITIVITY: per impostare il raggio di rilevamento del sensore (25% raggio minimo, 100% raggio massimo)
- RESET: ripristino delle impostazioni di default: viene attivata la MODE 1, tempo di accensione al 100% per 30s, livello di luce ambientale 20lux e raggio di rilevamento 50%

Se viene tolta tensione al proiettore, lo stesso si riaccenderà in modalità ON/OFF fino alla pressione di un tasto del telecomando.

Ogni volta che viene premuto un tasto il proiettore lampeggia una volta per confermare la ricezione del comando.

OPERATION

The ATLANTA projectors can be equipped with ATLANTAPIRB sensor sold separately, a PIR presence sensor that can be controlled via remote control.

Once the sensor has been installed, using the remote control you can control the floodlight setting functioning modes and parameters using the function keys:

- POWER ON the projector turns on 15s by default and then enters the last mode it was set to
- DAYLIGHT ONLY: disable the operation of the motion sensor, only the twilight sensor remains active
- SENSOR ON to activate tPIR sensor, the projector enters the last mode it was set to
- SENSOR OFF to bypassed the sensor operation, the projector is set to ON/OFF mode
- MODE 1: the projector will turn on at 100% when motion is detected, after the chosen power-on time it will turn off until motion is detected
- MODE 2: the projector will turn on at 100% when motion is detected, after the chosen power-on time it will stay on at 10% of the luminous flux until motion is detected
- MODE 3: the projector will turn on at 100% when motion is detected, after the chosen power-on time it will stay on at 20% of the luminous flux until motion is detected
- HOLD TIME: set the hold time of the projector when in 100% phase
- DAY-LIGHT LEVEL: set the ambient light level at which the projector will start operating
- SENSITIVITY : set the detection range of the sensor (25% minimum range, 100% maximum range)
- RESET: Restore factory settings: MODE 1 is activated, 100% emission hold time for 30s, daylight sensitivity 20lux and motion sensitivity 50%

When the main power is turned off, the projector will turn back on in ON/OFF mode until a key is pressed.

Each time a key is pressed, the projector flashes once to confirm receipt of the command.

AKRON 2

BTL CATEGORIA SCONTO 24

Proiettore a Led 12/24V / 12/24V Led floodlight

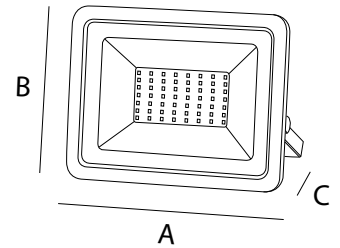

Dimensioni	A	B	C
1	124	100	24
2	159	122	26

- Corpo in alluminio pressofuso verniciato e diffusore in vetro temperato
- Funzionamento a 12-24V , ideale per imbarcazioni, camper e tutte le applicazioni in bassissima tensione

- Painted aluminum body with tempered glass diffuser
- 12-24V fixture, ideal for boats, campers and all low voltage applications



W	K	LUMEN APPARECCHIO lm	LUMEN SORGENTE lm	MISURE	VARIANTE	CODICE	EAN			
20	4000	1500	2000	120°	1	AKRONII20NLV	8031453029104	1/40	ATG	F
30	4000	2300	3000	120°	2	AKRONII30NLV	8031453029111	1/30	ATG	F



AKRON 2

SHOT
BOT LIGHTING

RESIDENZIALE / INTERNI & SOFFITTO
RESIDENTIAL / CEILING & INTERIOR

LOFT35

BTL CATEGORIA SCONTO 23

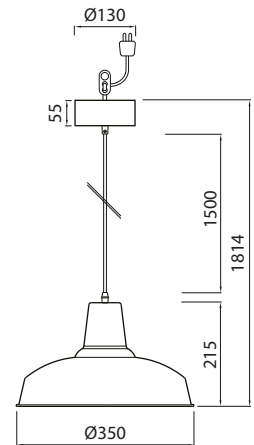

Lampada a sospensione / pendant lamp



_ Incluso cavo da 1,5 metri e coppa da soffitto
_ Attacco E27 per sorgenti LED max 20W

_ Supplied with 1.5-meters fabric power cord and ceiling cup
_ E27 base for LED light sources max 20W



W	BASE		VARIANTE	CODICE	EAN	
-	E27	-	<input type="checkbox"/> BIANCO / WHITE	9783080	6435200235985	1
-	E27	-	<input checked="" type="checkbox"/> NERO / BLACK	9783081	6435200236005	1



LOFT



SANSA

SANSA

BTL CATEGORIA SCONTO 23

Lampada a sospensione / pendant lamp

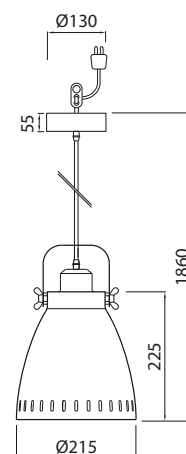

- Incluso cavo da 1,5 metri e coppa da soffitto
- Attacco E27 per sorgenti LED max 20W

- Supplied with 1.5-meters fabric power cord and ceiling cup
- E27 base for LED light sources max 20W



W	BASE		VARIANTE	CODICE	EAN	
-	E27	-	<input type="checkbox"/> BIANCO / WHITE	4118754	6435200226525	1/6
-	E27	-	<input checked="" type="checkbox"/> NERO / BLACK	4126225	6435200238207	1/6

URBAN

BTL CATEGORIA SCONTO 23

Lampada a sospensione / Pendant lamp



- _ Incluso cavo fino a 1,75 metri e coppa da soffitto
- _ Attacco E27 per sorgenti LED max 20W

- _ Supplied with 1,75 meters fabric power cord and ceiling cup
- _ E27 base for LED light sources max 20W



W	BASE		VARIANTE	CODICE	EAN	
-	E27	-	BIANCO / WHITE	9610559	6435200300706	1/2
-	E27	-	NERO / BLACK	9610560	6435200300713	1/2



URBAN

SHOT
BOT LIGHTING

RESIDENZIALE / TAVOLO E PAVIMENTO
RESIDENTIAL / FLOOR & TABLE

URBAN DESK S

BTL CATEGORIA SCONTO 23

Lampada da tavolo / Table lamp

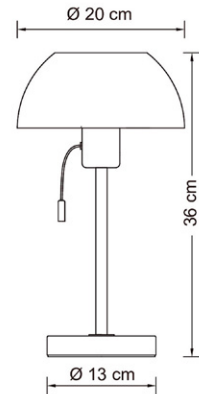

- _ Elegante lampada da tavolo dall'aspetto moderno
- _ Attacco E27 per sorgenti LED max 20W (si consiglia l'utilizzo di lampade di tipo sfera)
- _ Cavo rivestito in tessuto da 1,8 metri

- _ *Elegant table lamp with a modern look*
- _ *E27 base for LED light sources max 20W (P45 shaped bulbs recommended)*
- _ *1.8 meters fabric power cord*



W	BASE		VARIANTE	CODICE	EAN	
-	E27	-	<input type="checkbox"/> BIANCO / WHITE	9610563	6435200300744	1/2
-	E27	-	<input checked="" type="checkbox"/> NERO / BLACK	9610564	6435200300751	1/2



URBAN DESK S



URBAN DESK L

URBAN DESK L

BTL CATEGORIA SCONTO 23

Lampada da tavolo / Table lamp

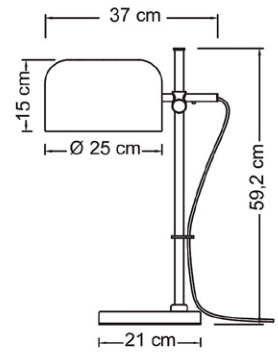

- _ Elegante lampada da tavolo dall'aspetto moderno
- _ Attacco E27 per sorgenti LED max 20W
- _ Cavo rivestito in tessuto da 1,8 metri

- _ *Elegant table lamp with a modern look*
- _ *E27 base for LED light sources max 20W*
- _ *1.8 meters fabric power cord*



W	BASE		VARIANTE	CODICE	EAN	
-	E27	-	 BIANCO / WHITE	9610567	6435200300782	1/2
-	E27	-	 NERO / BLACK	9610568	6435200300799	1/2

URBAN FLOOR

BTL CATEGORIA SCONTO 23

Lampada da terra / Floor lamp

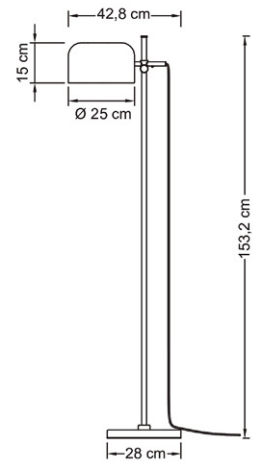

- _ Elegante lampada da terra dall'aspetto moderno
- _ Attacco E27 per sorgenti LED max 20W
- _ Cavo rivestito in tessuto da 1,8 metri

- _ *Elegant floor lamp with a modern look*
- _ *E27 base for LED light sources max 20W*
- _ *1.8 meters fabric power cord*



W	BASE		VARIANTE	CODICE	EAN	
-	E27	-	<input type="checkbox"/> BIANCO / WHITE	9610571	6435200300829	1/2
-	E27	-	<input checked="" type="checkbox"/> NERO / BLACK	9610572	6435200300836	1/2



URBAN FLOOR

CARA LED CLIP

BTL CATEGORIA SCONTO 23



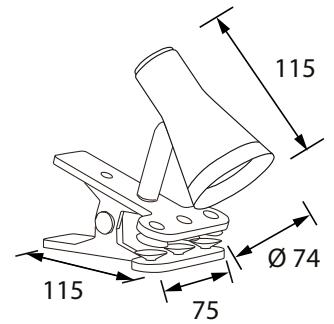

Lampada con fissaggio a clip / Clip wall lamp



- _ Elegante applique con sistema di aggancio a clip dall'aspetto moderno per interni.
- _ Fascio orientabile grazie allo snodo presente nello stelo.
- _ Interruttore su cavo.

- _ *Elegant table lamp with a modern look for indoors.*
- _ *Adjustable beam thanks to the joint in the stem.*
- _ *Switch on cable.*



W	K	LUMEN APPARECCHIO lm	VARIANTE	CODICE	EAN		
4,5	 3000	320	CLIP	9610414	6435200271938	1/24	

CARA LED WALL

BTL CATEGORIA SCONTO 23



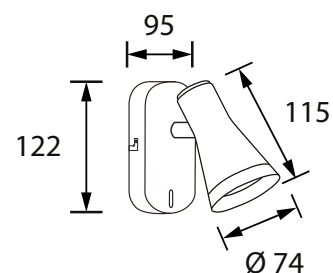

Applique / Wall lamp



- _ Elegante applique dall'aspetto moderno per interni.
- _ Fascio orientabile grazie allo snodo presente nello stelo.
- _ Interruttore su cavo.

- _ *Elegant wall light with a modern look for indoors.*
- _ *Adjustable beam thanks to the joint in the stem.*
- _ *Switch on cable.*



W	K	LUMEN APPARECCHIO lm	VARIANTE	CODICE	EAN		
4,5	 3000	320	WALL	9610415	6435200271976	1/24	

CARA LED TABLE

BTL CATEGORIA SCONTO 23



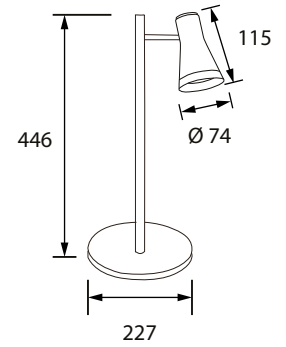

Lampada da tavolo / Table lamp



- _ Elegante lampada da tavolo dall'aspetto moderno per interni.
- _ Fascio orientabile grazie allo snodo presente nello stelo.

- _ *Elegant table lamp with a modern look for indoors.*
- _ *Adjustable beam thanks to the joint in the stem.*



W	K	LUMEN APPARECCHIO lm	VARIANTE	CODICE	EAN		
4,5	 3000	320	STAND	9610413	6435200271891	1/12	



CARA LED TABLE

SHOT
BOT LIGHTING

**RESIDENZIALE / LAMPADE DA TAVOLO
RICARICABILI**

RESIDENTIAL / RECHARGEABLE
TABLE LAMPS

SAN

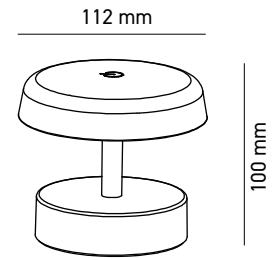
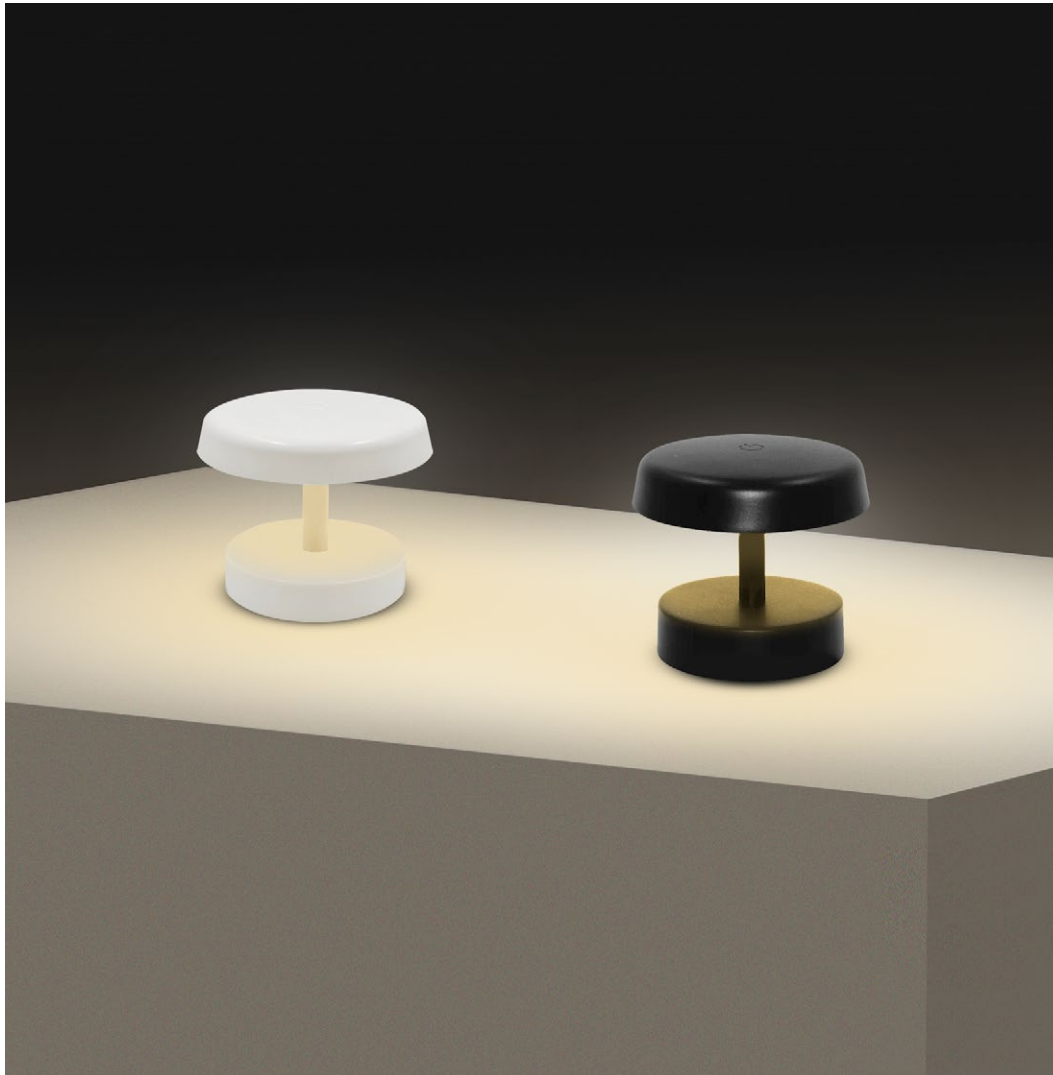

Lampada da tavolo ricaricabile / Rechargeable table lamp



- _ Lampada da tavolo a batteria ricaricabile IP44
- _ Corpo in ABS
- _ Completa di cavo di alimentazione USB-C da 1m (alimentatore non incluso)
- _ Superficie touch di accensione e regolazione della luce
- _ Batteria al litio
- _ Tempo di ricarica 3 ore
- _ Tempo di funzionamento da 3,5 a 60 ore (a seconda della dimmerazione)

- _ IP44 rechargeable battery table lamp
- _ ABS body
- _ Supplied with 1m USB-C power cable (power adapter not included)
- _ Touch surface for power on and light adjustment
- _ Lithium battery
- _ Charging time 3 hours
- _ Operating time from 3,5 to 60 hours (depending on dimming)



W	K	LUMEN APPARECCHIO lm	VARIANTE	CODICE	EAN	
0,8	 3000	80	<input type="checkbox"/> BIANCO / WHITE	SAN-B	8031453031862	1/27
0,8	 3000	80	<input checked="" type="checkbox"/> NERO / BLACK	SAN-N	8031453031886	1/27
Cavo di ricarica USB-A - USB-C 1m / USB-A - USB-C charging cable 1m				CABLETL	8031453032340	1
HUB di ricarica USB - 10 porte - 50W/ USB charging HUB - 10 ports - 50W				HUBTL50	8031453033033	1



HUB di ricarica USB - 10 porte - 50W/
USB charging HUB - 10 ports - 50W
HUBTL50



SAN

EMMA

BTL CATEGORIA SCONTO 23

















Lampada da tavolo ricaricabile / Rechargeable table lamp



- _ Lampada da tavolo a batteria ricaricabile IP54
- _ Corpo in alluminio e diffusore in policarbonato
- _ Completa di base di ricarica magnetica con cavo di alimentazione USB da 1,5m (alimentatore non incluso)
- _ Superficie touch di accensione e regolazione della luce
- _ Batteria al litio
- _ Tempo di ricarica 6 ore
- _ Tempo di funzionamento da 9 a 48 ore (a seconda della dimmerazione)

- _ IP54 rechargeable battery table lamp
- _ Aluminum body and polycarbonate diffuser
- _ Supplied with 1.5m USB cabled magnetic charging base (power adapter not included)
- _ Touch surface for power on and light adjustment
- _ Lithium battery
- _ 6 hours charging time
- _ Operating time from 9 to 48 hours (depending on dimming)



W	K	LUMEN APPARECCHIO lm	VARIANTE	CODICE	EAN	
3		3000	250  CARTA DA ZUCCHERO / PASTEL BLUE	EMMA-A	8031453028404	1/8
3		3000	250  BIANCO / TRAFFIC WHITE	EMMA-B	8031453031176	1/8
3		3000	250  CORTEN	EMMA-C	8031453031169	1/8
3		3000	250  AVORIO / LIGHT IVORY	EMMA-I	8031453028411	1/8
3		3000	250  NERO / TRAFFIC BLACK	EMMA-N	8031453031183	1/8
3		3000	250  BLU PETROLIO / OCEAN BLUE	EMMA-P	8031453028381	1/8
3		3000	250  ROSSO LAMPONE / RASPBERRY RED	EMMA-R	8031453028398	1/8
3		3000	250  VERDE SALVIA / PALE GREEN	EMMA-V	8031453028374	1/8
Base di ricarica / Charging base				EMMACB	8031453032319	1
Base di ricarica multipla 12 posti / Multiple charging base 12 places				EMMACB12	8031453032333	1
HUB di ricarica USB - 10 porte - 50W/ USB charging HUB - 10 ports - 50W				HUBTL50	8031453033033	1



Base di ricarica multipla 12 posti /
Multiple charging base 12 places
EMMACB12

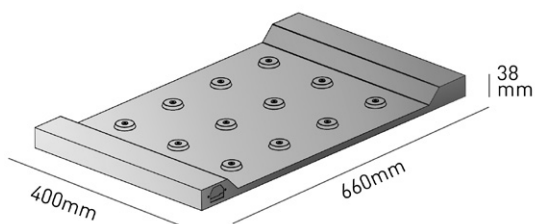

HUB di ricarica USB - 10 porte - 50W/
USB charging HUB - 10 ports - 50W
HUBTL50



EMMA MINI

BTL CATEGORIA SCONTO 23

Lampada da tavolo ricaricabile / Rechargeable table lamp

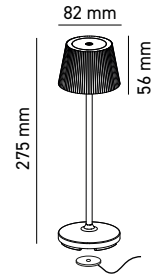



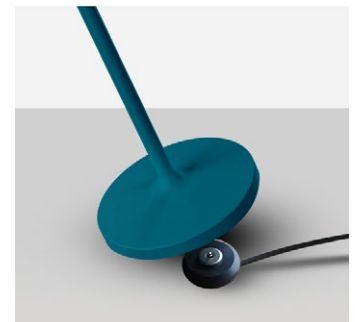













Base di ricarica / Charging base



- Lampada da tavolo a batteria ricaricabile IP54
- Corpo in alluminio e diffusore in policarbonato
- Completa di base di ricarica magnetica con cavo di alimentazione USB da 1,5m (alimentatore non incluso)
- Superficie touch di accensione e regolazione della luce
- Batteria al litio
- Tempo di ricarica 6 ore
- Tempo di funzionamento da 9 a 48 ore (a seconda della dimmerazione)

- IP54 rechargeable battery table lamp
- Aluminum body and polycarbonate diffuser
- Supplied with 1.5m USB cabled magnetic charging base (power adapter not included)
- Touch surface for power on and light adjustment
- Lithium battery
- 6 hours charging time
- Operating time from 9 to 48 hours (depending on dimming)



W	K	LUMEN APPARECCHIO lm	VARIANTE	CODICE	EAN	
1,5		3000	130  CARTA DA ZUCCHERO / PASTEL BLUE	EMMAMINI-A	8031453031213	1/12
1,5		3000	130  BIANCO / TRAFFIC WHITE	EMMAMINI-B	8031453031220	1/12
1,5		3000	130  CORTEN	EMMAMINI-C	8031453031237	1/12
1,5		3000	130  AVORIO / LIGHT IVORY	EMMAMINI-I	8031453031244	1/12
1,5		3000	130  NERO / TRAFFIC BLACK	EMMAMINI-N	8031453031251	1/12
1,5		3000	130  BLU PETROLIO / OCEAN BLUE	EMMAMINI-P	8031453031268	1/12
1,5		3000	130  ROSSO LAMPONE / RASPBERRY RED	EMMAMINI-R	8031453031275	1/12
1,5		3000	130  VERDE SALVIA / PALE GREEN	EMMAMINI-V	8031453031282	1/12
Base di ricarica / Charging base				EMMAMINICB	8031453032326	1
Base di ricarica multipla 12 posti / Multiple charging base 12 places				EMMACB12	8031453032333	1
HUB di ricarica USB - 10 porte - 50W/ USB charging HUB - 10 ports - 50W				HUBTL50	8031453033033	1



Base di ricarica multipla 12 posti /
Multiple charging base 12 places
EMMACB12

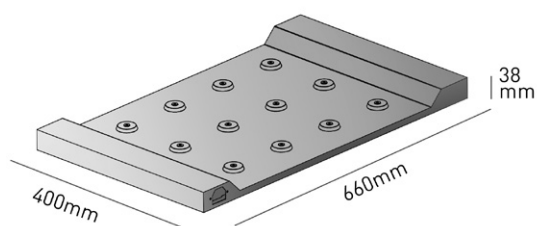

HUB di ricarica USB - 10 porte - 50W/
USB charging HUB - 10 ports - 50W
HUBTL50



EMMA MINI

MAYA

BTL CATEGORIA SCONTO 23

Lampada da tavolo ricaricabile / Rechargeable table lamp

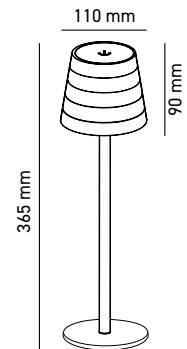





Ricaricabile / Rechargeable USB-C



- Lampada da tavolo a batteria ricaricabile IP54
- Paralume dal design minimalista geometrico a gradini
- Corpo in alluminio e diffusore in policarbonato
- Completa di cavo di alimentazione USB-C da 1m (alimentatore non incluso)
- Superficie touch di accensione e regolazione della luce
- Batteria al litio
- Tempo di ricarica 10/12 ore
- Tempo di funzionamento da 9 a 48 ore (a seconda della dimmerazione)

- IP54 rechargeable battery table lamp
- Lampshade with minimalist stepped geometric design
- Aluminum body and polycarbonate diffuser
- Supplied with 1m USB-C power cable (power adapter not included)
- Touch surface for power on and light adjustment
- Lithium battery
- Charging time 10/12 hours
- Operating time from 9 to 48 hours (depending on dimming)



W	K	LUMEN APPARECCHIO lm	VARIANTE	CODICE	EAN	
3	 3000	250	<input type="checkbox"/> BIANCA / WHITE	MAYA-B	8031453028343	1/8
3	 3000	250	<input checked="" type="checkbox"/> NERO / BLACK	MAYA-N	8031453028350	1/8
3	 3000	250	<input checked="" type="checkbox"/> CORTEN	MAYA-C	8031453028367	1/8
Cavo di ricarica USB-A - USB-C 1m / USB-A - USB-C charging cable 1m				CABLETL	8031453032340	1
HUB di ricarica USB - 10 porte - 50W/ USB charging HUB - 10 ports - 50W				HUBTL50	8031453033033	1



HUB di ricarica USB - 10 porte - 50W/
USB charging HUB - 10 ports - 50W
HUBTL50



MAYA

TAG

BTL CATEGORIA SCONTO 23

Lampada da tavolo ricaricabile / Rechargeable table lamp



- Lampada da tavolo a batteria ricaricabile IP54
- Corpo in alluminio e diffusore in policarbonato trasparente
- Completa di base di ricarica con cavo di alimentazione USB da 1 m (alimentatore non incluso)
- Superficie touch di accensione e regolazione della luce
- Batteria al litio
- Tempo di ricarica 4 ore
- Tempo di funzionamento da 4 a 25 ore (a seconda della dimmerazione)

- IP54 rechargeable battery table lamp
- Aluminum body and transparent polycarbonate diffuser
- Supplied with 1m USB cabled charging base (power adapter not included)
- Touch surface for power on and light adjustment
- Lithium battery
- Charging time 4 hours
- Operating time from 4 to 25 hours (depending on dimming)



W	K	LUMEN APPARECCHIO lm	VARIANTE	CODICE	EAN	
3	 3000	250	 CARTA DA ZUCCHERO / PASTEL BLUE	TAG-A	8031453031060	1/16
3	 3000	250	 BIANCO / TRAFFIC WHITE	TAG-B	8031453031046	1/16
3	 3000	250	 CORTEN	TAG-C	8031453031053	1/16
3	 3000	250	 AVORIO / LIGHT IVORY	TAG-I	8031453031077	1/16
3	 3000	250	 NERO / TRAFFIC BLACK	TAG-N	8031453031039	1/16
3	 3000	250	 BLU PETROLIO / OCEAN BLUE	TAG-P	8031453031084	1/16
3	 3000	250	 ROSSO LAMPONE / RASPBERRY RED	TAG-R	8031453031091	1/16
3	 3000	250	 VERDE SALVIA / PALE GREEN	TAG-V	8031453031107	1/16
Base di ricarica per lampada da tavolo / Charging base for table lamp				TAGCB	8031453032388	1
HUB di ricarica USB - 10 porte - 50W/ USB charging HUB - 10 ports - 50W				HUBTL50	8031453033033	1



HUB di ricarica USB - 10 porte - 50W/
USB charging HUB - 10 ports - 50W
HUBTL50



TAG

MAGNETIKA

BTL CATEGORIA SCONTO 23

Lampada da tavolo ricaricabile multifunzione / Multifunction rechargeable table lamp

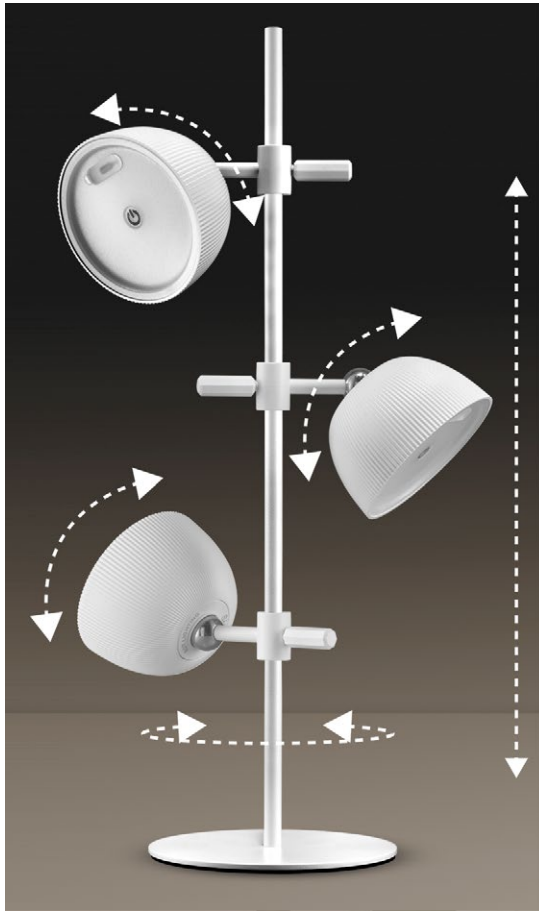

Pinza clip on
Clip on lamp



Innesto magnetico
Magnetic coupling



Piastra di fissaggio da parete
(biadesivo incluso)
Wall fixing plate
(double sided tape included)

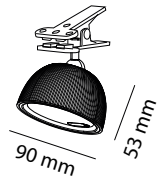
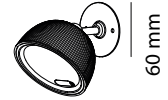
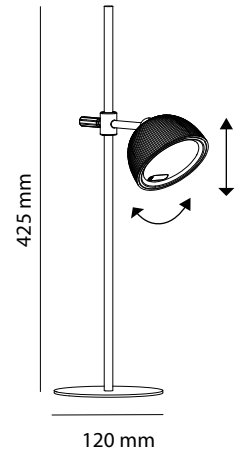

- Lampada da tavolo a batteria ricaricabile IP54
- Design moderno e minimalista adatto ad ogni ambiente
- Struttura in metallo, corpo e diffusore in policarbonato
- Completa di cavo di alimentazione USB-C da 1m (alimentatore non incluso)
- Accensione, spegnimento e regolazione tramite il tocco del diffusore
- Batteria al litio
- Tempo di ricarica 4-6 ore
- Tempo di funzionamento da 6 a 20 ore (a seconda della dimmerazione)
- In dotazione 2 accessori per installazione: clip e piastra di fissaggio

- IP54 rechargeable battery table lamp
- Modern and minimalist design suitable for any environment
- Metal structure, polycarbonate body and diffuser
- Supplied with 1m USB-C power cable (power adapter not included)
- On, off and dimming by touching the diffuser
- Lithium battery
- Charging time 4-6 hours
- Operating time from 6 to 20 hours (depending on dimming and environmental conditions)
- Supplied with 2 installation accessories: clip and fixing plate



W	K	LUMEN APPARECCHIO lm	VARIANTE	CODICE	EAN	
3	3000	200	<input type="checkbox"/> BIANCO / WHITE	MAGNETIKAB	8031453030315	1/12
3	3000	200	<input checked="" type="checkbox"/> NERO / BLACK	MAGNETIKAN	8031453030322	1/12
3	3000	200	<input type="checkbox"/> SILVER	MAGNETIKAS	8031453030339	1/12
Cavo di ricarica USB-A - USB-C 1m / USB-A - USB-C charging cable 1m				CABLETL	8031453032340	1
HUB di ricarica USB - 10 porte - 50W/ USB charging HUB - 10 ports - 50W				HUBTL50	8031453033033	1



HUB di ricarica USB - 10 porte - 50W/
USB charging HUB - 10 ports - 50W
HUBTL50



MAGNETIKA

TIZIA

BTL CATEGORIA SCONTO 23

Lampada da tavolo ricaricabile solare / Rechargeable table and solar lamp

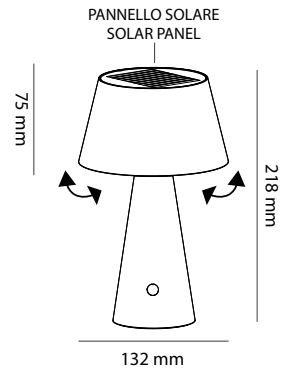











Varie modalità di funzionamento programmabili tramite il tasto di accensione

Different operation modes programmable via the power button

- _ Lampada da tavolo IP54 a ricarica solare e USB-C
- _ Corpo in ABS e diffusore in PS
- _ Pannello solare monocristallino da 0,5Wp
- _ Paralume orientabile
- _ Batteria al litio
- _ Tempo di ricarica 4 ore, tramite cavo USB C (non incluso)
- _ Tempo di funzionamento da 2 a 8 ore (a seconda della dimmerazione)

- _ *IP54 rechargeable solar and USB-C table lamp*
- _ *ABS body and PS diffuser*
- _ *0,5Wp monocristallin solar panel*
- _ *Adjustable lampshade*
- _ *Lithium battery*
- _ *Charging time 4 hours, via USB C cable (not included)*
- _ *Operating time from 2 to 8 hours (depending on dimming)*



W	K	LUMEN APPARECCHIO lm	VARIANTE	CODICE	EAN		
2,6		3000	500	 BLU / BLUE	TIZIA-B	8031453031121	1/18
2,6		3000	500	 NERO / TRAFFIC BLACK	TIZIA-N	8031453031312	1/18
2,6		3000	500	 ROSSO / RED	TIZIA-R	8031453031114	1/18
2,6		3000	500	 VERDE / GREEN	TIZIA-V	8031453031138	1/18
2,6		3000	500	 BIANCO / TRAFFIC WHITE	TIZIA-W	8031453031145	1/18
Cavo di ricarica USB-A - USB-C 1m / USB-A - USB-C charging cable 1m				CABLETL	8031453032340	1	
HUB di ricarica USB - 10 porte - 50W/ USB charging HUB - 10 ports - 50W				HUBTL50	8031453033033	1	



HUB di ricarica USB - 10 porte - 50W/
USB charging HUB - 10 ports - 50W

HUBTL50



TIZIA



SHOT
BOT LIGHTING

RESIDENZIALE / LAMPADE OUTDOOR
RESIDENTIAL / OUTDOOR LAMPS

ALICANTE

BTL CATEGORIA SCONTO 24

Applique / Wall lamp

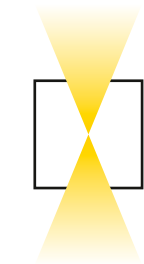
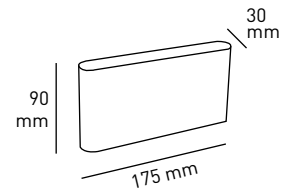

Fascio doppio
Double beam

- _ Applique da parete in alluminio per interni ed esterni
- _ Corpo in alluminio pressofuso verniciato
- _ Moduli LED integrati 2X5W (doppia emissione)
- _ CCT selezionabile

- _ Aluminum wall light for indoors and outdoors
- _ Painted die-cast aluminium body
- _ Built-in LED modules 2X5W (up and down)
- _ Selectable CCT



W	K	LUMEN APPARECCHIO lm	LUMEN SORGENTE lm		VARIANTE	CODICE	EAN		
10	<input type="checkbox"/> 3000 <input type="checkbox"/> 4000 <input type="checkbox"/> 5500	580	820	2X150°	<input type="checkbox"/> BIANCO / WHITE	ALICANTE10B	8031453022013	1/20	
10	<input type="checkbox"/> 3000 <input type="checkbox"/> 4000 <input type="checkbox"/> 5500	500	820	2X150°	<input checked="" type="checkbox"/> ANTRACITE / ANTHRACITE	ALICANTE10G	8031453022020	1/20	



ALICANTE

MADRID 7

BTL CATEGORIA SCONTO 24

Applique / Wall lamp

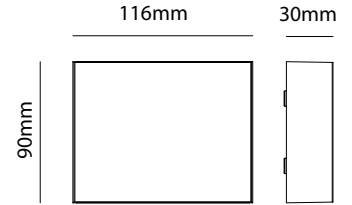

Fascio doppio
Double beam

- _ Applique da parete per interni ed esterni
- _ Corpo in alluminio pressofuso verniciato
- _ Moduli LED integrati 2x3,5W (doppia emissione)
- _ CCT selezionabile

- _ Interior and exterior wall light in aluminium
- _ Painted die-cast aluminum body
- _ Built-in 2x3,5W LED module (up and down)
- _ Selectable CCT



W	K	LUMEN APPARECCHIO lm	LUMEN SORGENTE lm		VARIANTE	CODICE	EAN		
7	<input type="checkbox"/> 3000 <input type="checkbox"/> 4000 <input type="checkbox"/> 5000	510	740	2x90°	<input type="checkbox"/> BIANCO / WHITE	MADRID7BK	8031453030636	1/20	
7	<input type="checkbox"/> 3000 <input type="checkbox"/> 4000 <input type="checkbox"/> 5000	490	740	2x90°	<input checked="" type="checkbox"/> ANTRACITE / ANTHRACITE	MADRID7GK	8031453030643	1/20	
7	<input type="checkbox"/> 3000 <input type="checkbox"/> 4000 <input type="checkbox"/> 5000	490	740	2x90°	<input checked="" type="checkbox"/> CORTEN	MADRID7CK	8031453030650	1/20	



MADRID 7

MADRID 24

BTL CATEGORIA SCONTO 24

Applique / Wall lamp

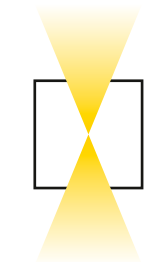
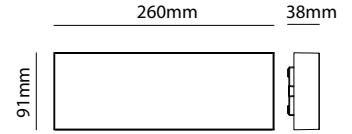
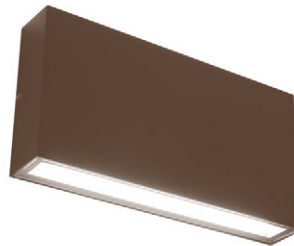

Fascio doppio
Double beam

- _ Applique da parete in alluminio per interni ed esterni
- _ Corpo in alluminio pressofuso verniciato
- _ Moduli LED integrati 2x12W (doppia emissione)
- _ CCT selezionabile

- _ Interior and exterior wall light in aluminium
- _ Painted die-cast aluminum body
- _ Built-in LED 2x12W (up and down)
- _ Selectable CCT



W	K	LUMEN APPARECCHIO lm	LUMEN SORGENTE lm		VARIANTE	CODICE	EAN		
24	<input type="checkbox"/> 3000 <input type="checkbox"/> 4000 <input type="checkbox"/> 5000	1690	2900	2x90°	<input type="checkbox"/> BIANCO / WHITE	MADRID24BK	8031453030667	1/10	
24	<input type="checkbox"/> 3000 <input type="checkbox"/> 4000 <input type="checkbox"/> 5000	1610	2900	2x90°	<input checked="" type="checkbox"/> ANTRACITE / ANTHRACITE	MADRID24GK	8031453030674	1/10	
24	<input type="checkbox"/> 3000 <input type="checkbox"/> 4000 <input type="checkbox"/> 5000	1600	2900	2x90°	<input checked="" type="checkbox"/> CORTEN	MADRID24CK	8031453030681	1/10	



MADRID 24

NIVES1 **NEW**

BTL CATEGORIA SCONTO 24

Applique singola emissione / Single emission wall lamp

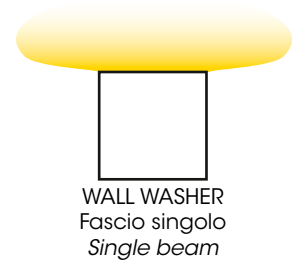
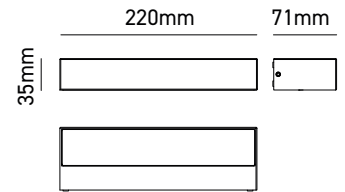

Applique da parete in alluminio con effetto wall washer, perfetta per creare un'illuminazione scenografica. Il suo design elegante è ideale per ambienti sia interni che esterni. La soluzione perfetta per un'illuminazione funzionale e stilisticamente raffinata.

Wall-mounted aluminum light fixture with a wall washer effect, perfect for creating dramatic lighting. Its elegant design makes it ideal for both indoor and outdoor spaces. The perfect solution for functional and stylishly refined lighting

- Applique da parete con corpo in alluminio e diffusore in vetro per interni ed esterni
- Modulo LED integrato da 12W
- Fascio singolo effetto wall washer
- CCT selezionabile

- Aluminum body and glass diffuser wall light for indoor and outdoor use
- Integrated 12W LED module
- Single beam with wall washer effect
- Selectable CCT



W	K	LUMEN APPARECCHIO lm	LUMEN SORGENTE lm		VARIANTE	CODICE	EAN		
12	<input type="checkbox"/> 3000 <input type="checkbox"/> 4000 <input type="checkbox"/> 5000	1000	1600	85°	<input type="checkbox"/> BIANCO / WHITE	NIVES112BK	8031453032456	1/20	
12	<input type="checkbox"/> 3000 <input type="checkbox"/> 4000 <input type="checkbox"/> 5000	950	1600	85°	<input checked="" type="checkbox"/> ANTRACITE / ANTHRACITE	NIVES112GK	8031453032470	1/20	
12	<input type="checkbox"/> 3000 <input type="checkbox"/> 4000 <input type="checkbox"/> 5000	950	1600	85°	<input checked="" type="checkbox"/> CORTEN	NIVES112CK	8031453032463	1/20	



NIVES 1

Applique doppia emissione / Double emission wall lamp

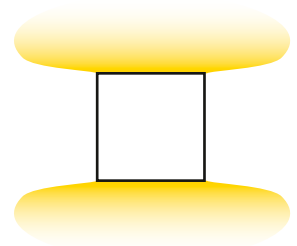
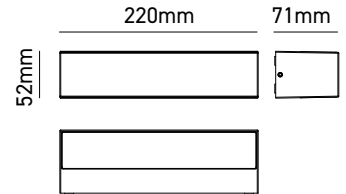

WALL WASHER
Fascio doppio
Double beam

Applique da parete in alluminio con effetto wall washer, perfetta per creare un'illuminazione scenografica. Il suo design elegante è ideale per ambienti sia interni che esterni. La soluzione perfetta per un'illuminazione funzionale e stilisticamente raffinata

Wall-mounted aluminum light fixture with a wall washer effect, perfect for creating dramatic lighting. Its elegant design makes it ideal for both indoor and outdoor spaces. The perfect solution for functional and stylishly refined lighting

- Applique da parete con corpo in alluminio e diffusore in vetro per interni ed esterni
- Moduli LED integrati 2x10W (doppia emissione)
- Doppia emissione effetto wall washer
- CCT selezionabile

- Aluminum body and glass diffuser wall light for indoor and outdoor use
- Integrated LED modules 2x10W
- Dual emission with wall washer effect
- Selectable CCT



W	K	LUMEN APPARECCHIO lm	LUMEN SORGENTE lm		VARIANTE	CODICE	EAN		
20	<input type="checkbox"/> 3000 <input type="checkbox"/> 4000 <input type="checkbox"/> 5000	1700	2600	2x85°	<input type="checkbox"/> BIANCO / WHITE	NIVES220BK	8031453032487	1/20	
20	<input type="checkbox"/> 3000 <input type="checkbox"/> 4000 <input type="checkbox"/> 5000	1550	2600	2x85°	<input checked="" type="checkbox"/> ANTRACITE / ANTHRACITE	NIVES220GK	8031453032500	1/20	
20	<input type="checkbox"/> 3000 <input type="checkbox"/> 4000 <input type="checkbox"/> 5000	1600	2600	2x85°	<input checked="" type="checkbox"/> CORTEN	NIVES220CK	8031453032494	1/20	



NIVES 2

LUNA

BTL CATEGORIA SCONTO 24

Applique / Wall lamp

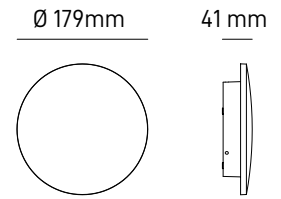

- Applique da parete rotonda in alluminio
- Modulo LED integrato da 9W - 1000lm
- Illuminazione posteriore indiretta
- Verniciatura a polveri resistente ai raggi UV

- Round aluminum wall light
- Integrated 9W - 1000lm LED module
- Indirect rear lighting
- UV-resistant powder coating



W	K	LUMEN APPARECCHIO lm	LUMEN SORGENTE lm		VARIANTE	CODICE	EAN		
9	<input type="checkbox"/> 3000 <input type="checkbox"/> 4000 <input type="checkbox"/> 5200	870	1000	75°	<input type="checkbox"/> BIANCO / WHITE	LUNA9B	8031453027469	1/12	
9	<input type="checkbox"/> 3000 <input type="checkbox"/> 4000 <input type="checkbox"/> 5200	630	1000	75°	<input checked="" type="checkbox"/> ANTRACITE / ANTHRACITE	LUNA9G	8031453027476	1/12	



LUNA

NORAMINI NEW

BTL CATEGORIA SCONTO 24

Applique / Wall lamp

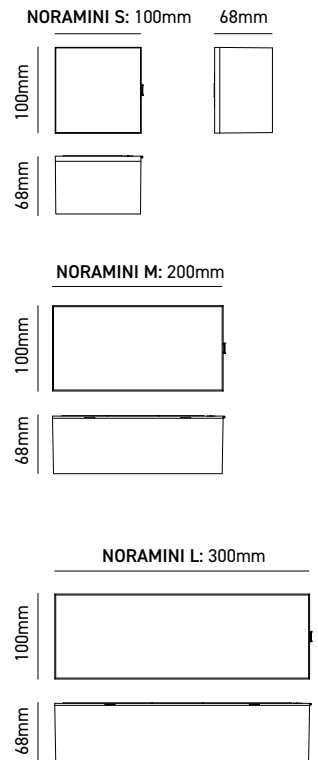

- _ Applique in policarbonato, IP65, ideale sia per esterni che per interni
- _ Disponibile in tre misure e due forme differenti
- _ Potenza e CCT selezionabili

- _ Polycarbonate wall light, IP65 rated, ideal for both outdoor and indoor use
- _ Available in three sizes and two different shapes
- _ Power and CCT selectable



W	K	LUMEN APPARECCHIO lm	LUMEN SORGENTE lm		VARIANTE	CODICE	EAN		
2	3000	200	300	150°	SMALL	NORAMINIS	8031453034610	1/20	
3	4000	300	400						
4	6000	400	500						
4	3000	350	500	150°	MEDIUM	NORAMINIM	8031453034627	1/10	
6	4000	500	700						
8	6000	700	950						
8	3000	650	900	150°	LARGE	NORAMINIL	8031453034634	1/10	
10	4000	800	1150						
12	6000	1000	1400						



NORA MINI

MARBELLA SQUARED AGGIORNATO

BTL CATEGORIA SCONTO 24

Applique / Wall lamp

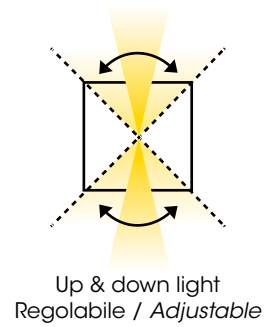
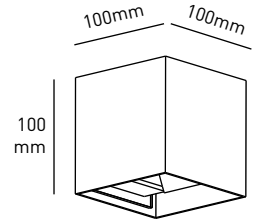

- _ Applique da parete in alluminio per interni ed esterni
- _ Moduli LED integrati 2x5W (doppia emissione)
- _ Doppio fascio regolabile 0° - 90° senza l'uso di attrezzi
- _ CCT selezionabile

- _ Interior and exterior wall light in aluminium
- _ Built-in LED modules 2x5W (up and down)
- _ Double light beam adjustable individually 0°-90° no tools needed
- _ Selectable CCT



W	K	LUMEN APPARECCHIO lm	LUMEN SORGENTE lm		VARIANTE	CODICE	EAN		
10	<input type="checkbox"/> 3000 <input type="checkbox"/> 4000 <input type="checkbox"/> 5500	590	610	2x90°	<input type="checkbox"/> BIANCO / WHITE	MARBELLA10BQK	8031453024994	1/20	
10	<input type="checkbox"/> 3000 <input type="checkbox"/> 4000 <input type="checkbox"/> 5500	480	610	2x90°	<input checked="" type="checkbox"/> ANTRACITE / ANTHRACITE	MARBELLA10GQK	8031453025007	1/20	
10	<input type="checkbox"/> 3000 <input type="checkbox"/> 4000 <input type="checkbox"/> 5500	520	610	2x90°	<input checked="" type="checkbox"/> GRIGIO MARINA / LIGHT GREY	MARBELLA10MQK	8031453025014	1/20	
10	<input type="checkbox"/> 3000 <input type="checkbox"/> 4000 <input type="checkbox"/> 5500	480	610	2x90°	<input checked="" type="checkbox"/> CORTEN	MARBELLA10CQK	8031453025021	1/20	
NEW	<input type="checkbox"/> 3000 <input type="checkbox"/> 4000 <input type="checkbox"/> 5500	480	610	2x90°	<input checked="" type="checkbox"/> NERO / BLACK	MARBELLA10NQK	8031453033774	1/20	

MARBELLA ROUND

BTL CATEGORIA SCONTO 24

Applique / Wall lamp

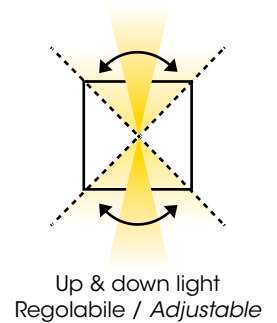
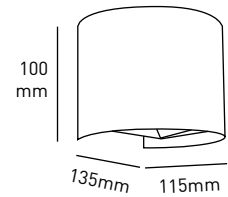

- Applique da parete in alluminio per interni ed esterni
- Moduli LED integrati 2x5W (doppia emissione)
- Doppio fascio regolabile 0° - 90° senza l'uso di attrezzi
- CCT selezionabile

- Interior and exterior wall light in aluminium
- Built-in LED modules 2x5W (up and down)
- Double light beam adjustable individually 0°-90° no tools needed
- Selectable CCT



W	K	LUMEN APPARECCHIO lm	LUMEN SORGENTE lm		VARIANTE	CODICE	EAN		
10	<input type="checkbox"/> 3000 <input type="checkbox"/> 4000 <input type="checkbox"/> 5500	590	610	2x90°	<input type="checkbox"/> BIANCO / WHITE	MARBELLA10BRK	8031453024963	1/20	
10	<input type="checkbox"/> 3000 <input type="checkbox"/> 4000 <input type="checkbox"/> 5500	480	610	2x90°	<input checked="" type="checkbox"/> ANTRACITE / ANTHRACITE	MARBELLA10GRK	8031453024970	1/20	
10	<input type="checkbox"/> 3000 <input type="checkbox"/> 4000 <input type="checkbox"/> 5500	480	610	2x90°	<input checked="" type="checkbox"/> CORTEN	MARBELLA10CRK	8031453025038	1/20	

MARBELLA BIG SQUARED

BTL CATEGORIA SCONTO 24

Applique / Wall lamp

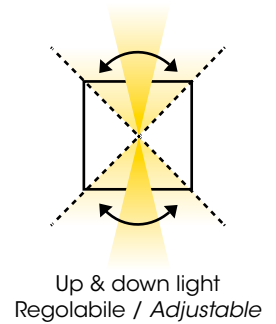
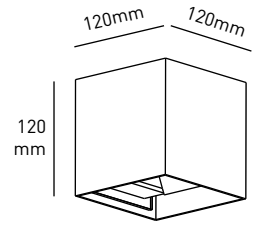

- _ Applique da parete in alluminio per interni ed esterni
- _ Moduli LED integrati 2x10W (doppia emissione)
- _ Doppio fascio regolabile 0° - 90° senza l'uso di attrezzi
- _ CCT selezionabile

- _ Interior and exterior wall light in aluminium
- _ Built-in LED modules 2x10W (up and down)
- _ Double light beam adjustable individually 0°-90° no tools needed
- _ Selectable CCT



W	K	LUMEN APPARECCHIO lm	LUMEN SORGENTE lm		VARIANTE	CODICE	EAN		
20	<input type="checkbox"/> 3000 <input type="checkbox"/> 4000 <input type="checkbox"/> 5500	1180	1220	2x90°	<input type="checkbox"/> BIANCO / WHITE	MARBELLA20BQK	8031453025878	1/10	
20	<input type="checkbox"/> 3000 <input type="checkbox"/> 4000 <input type="checkbox"/> 5500	960	1220	2x90°	<input checked="" type="checkbox"/> ANTRACITE / ANTHRACITE	MARBELLA20GQK	8031453025861	1/10	
20	<input type="checkbox"/> 3000 <input type="checkbox"/> 4000 <input type="checkbox"/> 5500	1040	1220	2x90°	<input checked="" type="checkbox"/> GRIGIO MARINA / LIGHT GREY	MARBELLA20MQK	8031453025885	1/10	
20	<input type="checkbox"/> 3000 <input type="checkbox"/> 4000 <input type="checkbox"/> 5500	960	1220	2x90°	<input checked="" type="checkbox"/> CORTEN	MARBELLA20CQK	8031453025892	1/10	



MARBELLA BIG

MARBELLA DUO

BTL CATEGORIA SCONTO 24

Applique / Wall lamp

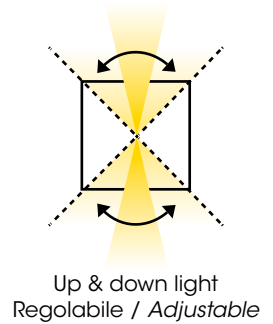
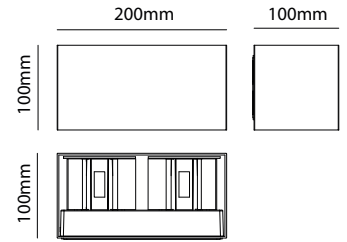

- _ Applique da parete in alluminio per interni ed esterni
- _ Moduli LED integrati 4X5W (quadrupla emissione)
- _ Quattro fasci regolabili separatamente 0° - 85° senza l'uso di attrezzi
- _ CCT selezionabile

- _ Aluminum wall light for indoors and outdoors
- _ Built-in LED modules 4x5W (quadruple emission)
- _ Four lights beam adjustable individually 0°-85° no tools needed
- _ Selectable CCT



W	K	LUMEN APPARECCHIO lm	LUMEN SORGENTE lm		VARIANTE	CODICE	EAN		
20	<input type="checkbox"/> 3000 <input type="checkbox"/> 4000 <input type="checkbox"/> 6500	1085	2040	4x85°	<input type="checkbox"/> BIANCO / WHITE	MARBELLADUO20BK	8031453030605	1/10	
20	<input type="checkbox"/> 3000 <input type="checkbox"/> 4000 <input type="checkbox"/> 6500	810	2040	4x85°	<input checked="" type="checkbox"/> ANTRACITE / ANTHRACITE	MARBELLADUO20GK	8031453030612	1/10	
20	<input type="checkbox"/> 3000 <input type="checkbox"/> 4000 <input type="checkbox"/> 6500	805	2040	4x85°	<input checked="" type="checkbox"/> CORTEN	MARBELLADUO20CK	8031453030629	1/10	



MARBELLA DUO

RONDA NEW

BTL CATEGORIA SCONTO 24

Plafoniera / Ceiling light

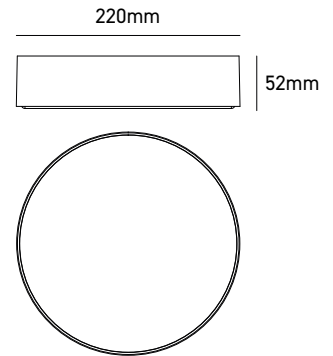

Plafoniera LED dal design moderno e versatile, disponibile in tre varianti di colore per adattarsi perfettamente a ogni ambiente. Un'opzione affidabile e dal gusto contemporaneo che aggiunge stile e funzionalità ad ogni spazio interno o esterno

LED ceiling light with a modern and versatile design, available in three color options to perfectly complement any setting. A reliable and contemporary choice that adds style and functionality to any indoor or outdoor space

- _ Plafoniera in alluminio per interni ed esterni
- _ Modulo LED integrato da 20W
- _ CCT selezionabile

- _ Aluminum ceiling light for indoor and outdoor use
- _ Integrated 20W LED module
- _ Selectable CCT



W	K	LUMEN APPARECCHIO lm	LUMEN SORGENTE lm		VARIANTE	CODICE	EAN		
20	<input type="checkbox"/> 3000 <input type="checkbox"/> 4000 <input type="checkbox"/> 5000	2000	2800	180°	<input type="checkbox"/> BIANCO / WHITE	RONDA20BK	8031453032395	1/10	
20	<input type="checkbox"/> 3000 <input type="checkbox"/> 4000 <input type="checkbox"/> 5000	1750	2800	180°	<input checked="" type="checkbox"/> ANTRACITE / ANTHRACITE	RONDA20GK	8031453032418	1/10	
20	<input type="checkbox"/> 3000 <input type="checkbox"/> 4000 <input type="checkbox"/> 5000	1700	2800	180°	<input checked="" type="checkbox"/> CORTEN	RONDA20CK	8031453032401	1/10	



RONDA

MALAGA AGGIORNATO

BTL CATEGORIA SCONTO 24

Plafone / Ceiling lamp

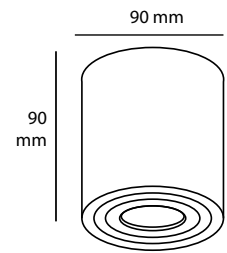

GU10 ALTA
TEMPERATURA
pag 95

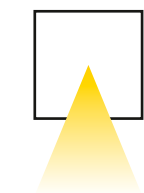







Fascio singolo
Single beam

_ Plafoniera in alluminio con schermo in vetro per interni ed esterni
_ Attacco GU10 per sorgenti LED max 7W (modello suggerito GU10 alta temperatura)

_ Interior and exterior ceiling light in aluminium with glass diffuser
_ GU10 base for LED light sources max 7W (suggested model high temperature GU10)



W	BASE		VARIANTE	CODICE	EAN	
-	GU10	-	 BIANCO / WHITE	MALAGAB	8031453025076	1/20
-	GU10	-	 ANTRACITE / ANTHRACITE	MALAGAG	8031453025090	1/20
-	GU10	-	 GRIGIO MARINA / LIGHT GREY	MALAGAM	8031453025106	1/20
-	GU10	-	 CORTEN	MALAGAC	8031453025083	1/20
NEW	GU10	-	 NERO / BLACK	MALAGAN	8031453033798	1/20

ALMERIA AGGIORNATO

BTL CATEGORIA SCONTO 24

Plafone / Ceiling lamp

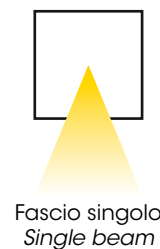
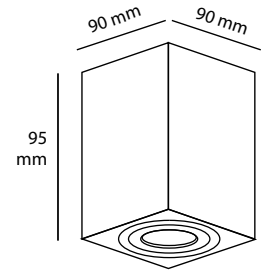
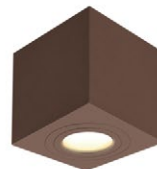

_ Plafoniera in alluminio con schermo in vetro per interni ed esterni
 _ Attacco GU10 per sorgenti LED max 7W (modello suggerito GU10 alta temperatura)

_ Interior and exterior ceiling light in aluminium with glass diffuser
 _ GU10 base for LED light sources max 7W (suggested model high temperature GU10)



W	BASE		VARIANTE	CODICE	EAN	
-	GU10	-	BIANCO / WHITE	ALMERIAB	8031453025113	1/20
-	GU10	-	ANTRACITE / ANTHRACITE	ALMERIAG	8031453025137	1/20
-	GU10	-	GRIGIO MARINA / LIGHT GREY	ALMERIAM	8031453025144	1/20
-	GU10	-	CORTEN	ALMERIAC	8031453025120	1/20
-	GU10	-	NERO / BLACK	ALMERIAN	8031453033781	1/20

NEW

TOLEDO 1 AGGIORNATO

BTL CATEGORIA SCONTO 24

Applique singola emissione / Single emission wall lamp

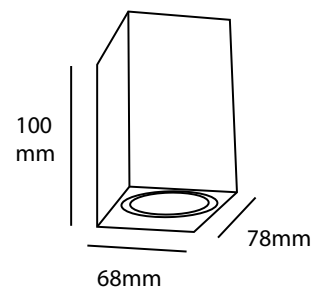

GU10 ALTA
TEMPERATURA
pag 95



Fascio singolo
Single beam

- _ Applique da parete in alluminio con schermo in vetro per interni ed esterni
- _ Attacco GU10 per sorgenti LED max 7W (modello suggerito GU10 alta temperatura)

- _ Interior and exterior wall light in aluminium with glass diffuser
- _ GU10 base for LED light sources max 7W (suggested model high temperature GU10)



W	BASE		VARIANTE	CODICE	EAN	
-	GU10	-	<input type="checkbox"/> BIANCO / WHITE	TOLEDO1B	8031453023829	1/40
-	GU10	-	<input checked="" type="checkbox"/> ANTRACITE / ANTHRACITE	TOLEDO1G	8031453023843	1/40
-	GU10	-	<input type="checkbox"/> GRIGIO MARINA / LIGHT GREY	TOLEDO1M	8031453023850	1/40
-	GU10	-	<input checked="" type="checkbox"/> CORTEN	TOLEDO1C	8031453023836	1/40
NEW	GU10	-	<input checked="" type="checkbox"/> NERO / BLACK	TOLEDO1N	8031453033804	1/40

TOLEDO 2 AGGIORNATO

BTL CATEGORIA SCONTO 24



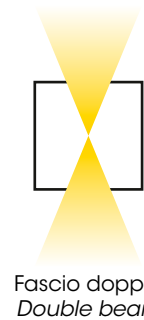
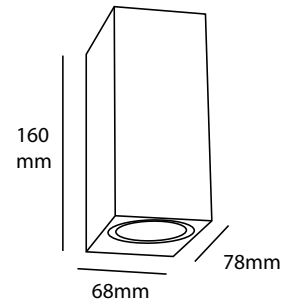



Applique doppia emissione / Double emission wall lamp



- Applique da parete in alluminio con schermo in vetro per interni ed esterni
- Attacco GU10 per sorgenti LED max 2x7W (modello suggerito GU10 alta temperatura)

- Interior and exterior wall light in aluminium with glass diffuser
- GU10 base for LED light sources max 2x7W (suggested model high temperature GU10)



W	BASE		VARIANTE	CODICE	EAN	
-	GU10	-	 BIANCO / WHITE	TOLEDO2B	8031453023867	1/20
-	GU10	-	 ANTRACITE / ANTHRACITE	TOLEDO2G	8031453023881	1/20
-	GU10	-	 GRIGIO MARINA / LIGHT GREY	TOLEDO2M	8031453023898	1/20
-	GU10	-	 CORTEN	TOLEDO2C	8031453023874	1/20
-	GU10	-	 NERO / BLACK	TOLEDO2N	8031453033811	1/20

NEW

TOLEDO 10

BTL CATEGORIA SCONTO 24

Applique / Wall lamp

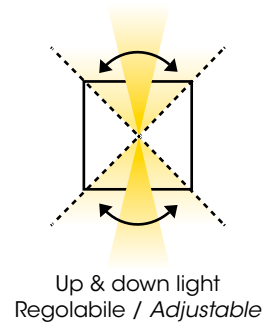
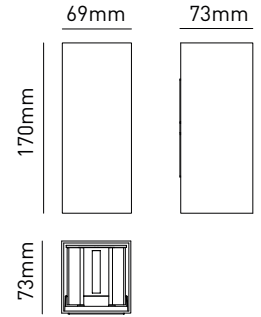

- _ Applique da parete in alluminio per interni ed esterni
- _ Moduli LED integrati 2X5W (doppia emissione)
- _ Doppio fascio regolabile 0° - 70° senza l'uso di attrezzi
- _ Scala graduata per regolazione dell'ampiezza del fascio
- _ CCT selezionabile

- _ Interior and exterior wall light in aluminium
- _ Built-in LED 2x5W (up and down)
- _ Double light beam adjustable individually 0°-70° no tools needed
- _ Graduated scale to adjust the beam width
- _ Selectable CCT



W	K	LUMEN APPARECCHIO lm	LUMEN SORGENTE lm		VARIANTE	CODICE	EAN		
10	<input type="checkbox"/> 3000 <input type="checkbox"/> 4000 <input type="checkbox"/> 6500	480	1020	2x70°	<input type="checkbox"/> BIANCO / WHITE	TOLEDO10BK	8031453030698	1/10	
10	<input type="checkbox"/> 3000 <input type="checkbox"/> 4000 <input type="checkbox"/> 6500	350	1020	2x70°	<input checked="" type="checkbox"/> ANTRACITE / ANTHRACITE	TOLEDO10GK	8031453030704	1/10	
10	<input type="checkbox"/> 3000 <input type="checkbox"/> 4000 <input type="checkbox"/> 6500	345	1020	2x70°	<input checked="" type="checkbox"/> CORTEN	TOLEDO10CK	8031453030711	1/10	



TOLEDO 10

SUND

Applique singola emissione / Single emission wall lamp

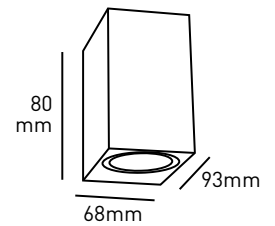

**GU10 ALTA
TEMPERATURA**
pag 95

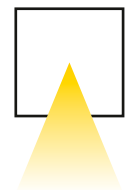

Fascio singolo
Single beam

- _ Applique da parete in alluminio con schermo in vetro per interni ed esterni
- _ Attacco GU10 per sorgenti LED max 11W (modello suggerito GU10 alta temperatura)

- _ Interior and exterior wall light in aluminium with glass diffuser
- _ GU10 base for LED light sources max 11W (suggested model high temperature GU10)



W	BASE		VARIANTE	CODICE	EAN	
-	GU10	-	BIANCO / WHITE	4118740	6435200226129	1/8
-	GU10	-	ANTRACITE / ANTHRACITE	4118745	6435200226228	1/8

SUND DUO

BTL CATEGORIA SCONTO 24

Applique doppia emissione / Double emission wall lamp

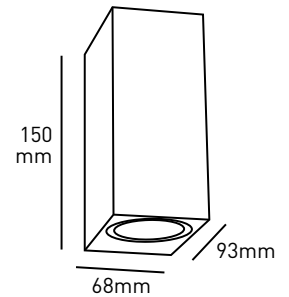

GU10 ALTA
TEMPERATURA
pag 95

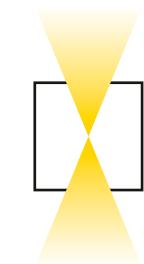





Fascio doppio
Double beam

- _ Applique da parete in alluminio con schermo in vetro per interni ed esterni
- _ Attacco GU10 per sorgenti LED max 2x11W (modello suggerito GU10 alta temperatura)

- _ Interior and exterior wall light in aluminium with glass diffuser
- _ GU10 base for LED light sources max 2x11W (suggested model high temperature GU10)



W	BASE		VARIANTE	CODICE	EAN	
-	GU10	-	 BIANCO / WHITE	4118742	6435200226167	1/8
-	GU10	-	 ANTRACITE / ANTHRACITE	4118746	6435200226242	1/8

CORDOVA 1

BTL CATEGORIA SCONTO 24

Applique singola emissione / Single emission wall lamp

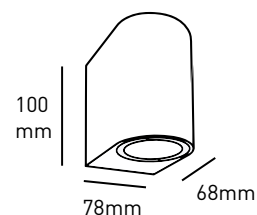

GU10 ALTA
TEMPERATURA
pag 95



Fascio singolo
Single beam

- Applique da parete in alluminio con schermo in vetro per interni ed esterni
- Attacco GU10 per sorgenti LED max 7W (modello suggerito GU10 alta temperatura)

- Interior and exterior wall light in aluminium with glass diffuser
- GU10 base for LED light sources max 7W (suggested model high temperature GU10)



W	BASE		VARIANTE	CODICE	EAN	
-	GU10	-	BIANCO / WHITE	CORDOVA1B	8031453021849	1/40
-	GU10	-	ANTRACITE / ANTHRACITE	CORDOVA1G	8031453021856	1/40
-	GU10	-	GRIGIO MARINA / LIGHT GREY	CORDOVA1M	8031453021863	1/40
-	GU10	-	CORTEN	CORDOVA1C	8031453023805	1/40

CORDOVA 2

BTL CATEGORIA SCONTO 24

Applique doppia emissione / Double emission wall lamp

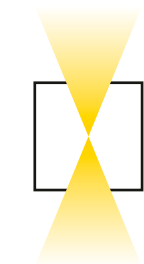
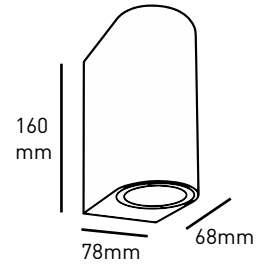







Fascio doppio
Double beam

- Applique da parete in alluminio con schermo in vetro per interni ed esterni
- Attacco GU10 per sorgenti LED max 2x7W (modello suggerito GU10 alta temperatura)

- Interior and exterior wall light in aluminium with glass diffuser
- GU10 base for LED light sources max 2x7W (suggested model high temperature GU10)



W	BASE		VARIANTE	CODICE	EAN	
-	GU10	-	 BIANCO / WHITE	CORDOVA2B	8031453021870	1/20
-	GU10	-	 ANTRACITE / ANTHRACITE	CORDOVA2G	8031453021887	1/20
-	GU10	-	 GRIGIO MARINA / LIGHT GREY	CORDOVA2M	8031453021894	1/20
-	GU10	-	 CORTEN	CORDOVA2C	8031453023812	1/20

CORDOVA 10

BTL CATEGORIA SCONTO 24

Applique / Wall lamp

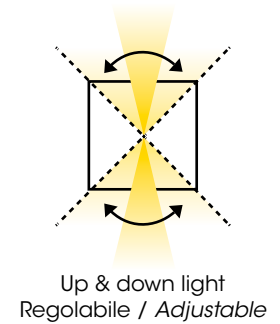
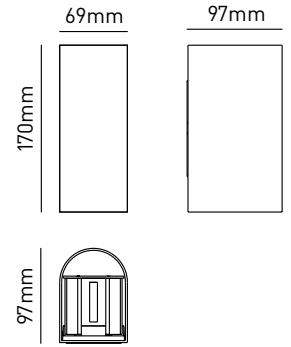

- _ Applique da parete in alluminio per interni ed esterni
- _ Moduli LED integrati 2X5W (doppia emissione)
- _ Doppio fascio regolabile 0° - 70° senza l'uso di attrezzi
- _ Scala graduata per regolazione dell'ampiezza del fascio
- _ CCT selezionabile

- _ Aluminium interior and exterior wall light
- _ Built-in LED modules 2X5W (double emission)
- _ Double light beam adjustable individually 0°-70° no tools needed
- _ Graduated scale to adjust the beam width
- _ Selectable CCT



W	K	LUMEN APPARECCHIO lm	LUMEN SORGENTE lm		VARIANTE	CODICE	EAN		
10	<input type="checkbox"/> 3000 <input type="checkbox"/> 4000 <input type="checkbox"/> 6500	510	1020	2x70°	<input type="checkbox"/> BIANCO / WHITE	CORDOVA10BK	8031453030728	1/10	
10	<input type="checkbox"/> 3000 <input type="checkbox"/> 4000 <input type="checkbox"/> 6500	360	1020	2x70°	<input checked="" type="checkbox"/> ANTRACITE / ANTHRACITE	CORDOVA10GK	8031453030735	1/10	
10	<input type="checkbox"/> 3000 <input type="checkbox"/> 4000 <input type="checkbox"/> 6500	350	1020	2x70°	<input checked="" type="checkbox"/> CORTEN	CORDOVA10CK	8031453030742	1/10	



CORDOVA10

AVILA

BTL CATEGORIA SCONTO 24

Applique con sensore crepuscolare / Wall light with dusk sensor

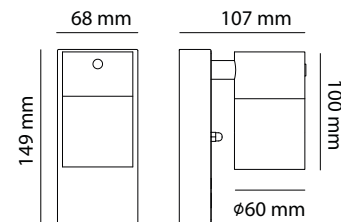

**GU10 ALTA
TEMPERATURA**
pag 95



Fascio singolo
Single beam

- _ Applique da parete in alluminio con diffusore in vetro
- _ Sensore crepuscolare con soglia di intervento 30-50lux
- _ Attacco GU10 per sorgenti LED max 7W (modello suggerito GU10 alta temperatura)
- _ Verniciatura a polveri resistente ai raggi UV

- _ Aluminum wall light with glass diffuser
- _ Twilight sensor with intervention threshold 30-50lux
- _ GU10 base for LED light sources max 7W (suggested model high temperature GU10)
- _ UV-resistant powder coating



W	BASE		VARIANTE	CODICE	EAN	
-	GU10	-	BIANCO / WHITE	AVILABS	8031453027773	1/20
-	GU10	-	ANTRACITE / ANTHRACITE	AVILAGS	8031453027780	1/20
-	GU10	-	CORTEN	AVILACS	8031453027797	1/20



AVILA

ALPILA 1S

BTL CATEGORIA SCONTO 24

Applique singola emissione / Single emission wall lamp



ART. 4107268

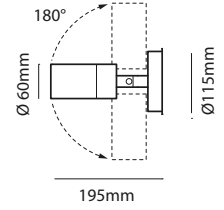

ART. 4107269

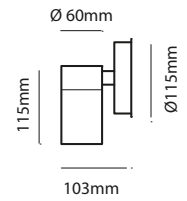

**GU10 ALTA
TEMPERATURA**
pag 95



Fascio singolo
Single beam

- _ Applique da parete in acciaio inox con schermo in vetro temperato per interni ed esterni
- _ Attacco GU10 per sorgenti LED max 7W (modello suggerito GU10 alta temperatura)
- _ Versione fissa ed orientabile

- _ Interior and exterior wall light in stainless steel with tempered glass diffuser
- _ GU10 base for LED light sources max 7W (suggested model high temperature GU10)
- _ Fixed and adjustable version



W	BASE		VARIANTE	CODICE	EAN	
-	GU10	-	ORIENTABILE / ADJUSTABLE	4107268	6435200147547	1/12
-	GU10	-	FISSA / FIXED	4107269	6435200147561	1/12

ALPILA 2S

BTL CATEGORIA SCONTO 24

Applique doppia emissione / Double emission wall lamp

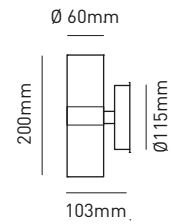

GU10 ALTA
TEMPERATURA
pag 95



Fascio doppio
Double beam

- Applique da parete in acciaio inox con schermo in vetro temperato per interni ed esterni
- Attacco GU10 per sorgenti LED max 2x7W (modello suggerito GU10 alta temperatura)

- Interior and exterior wall light in stainless steel with tempered glass diffuser
- GU10 base for LED light sources max 2x7W (suggested model high temperature GU10)



W	BASE		VARIANTE	CODICE	EAN	
-	GU10	-	 ACCIAIO / STEEL	4107271	6435200147585	1/12

ALPPILA XL

BTL CATEGORIA SCONTO 24

Applique doppia emissione / Double emission wall lamp

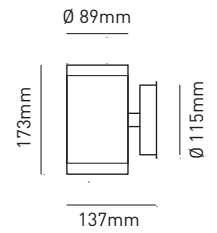

GU10 ALTA
TEMPERATURA
pag 95



Fascio doppio
Double beam

- _ Applique da parete in acciaio inox con schermo in vetro temperato per interni ed esterni
- _ Attacco GU10 per sorgenti LED max 2x7W (modello suggerito GU10 alta temperatura)

- _ Interior and exterior wall light in stainless steel with tempered glass diffuser
- _ GU10 base for LED light sources max 2x7W (suggested model high temperature GU10)



W	BASE		VARIANTE	CODICE	EAN	
-	-	-	BIANCO / WHITE	4508465	6435200196163	1/12
-	-	-	ANTRACITE / ANTHRACITE	4508466	6435200196187	1/12

GRANADA

BTL CATEGORIA SCONTO 24

Applique doppia emissione / Double emission wall lamp

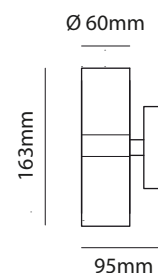

GU10 ALTA
TEMPERATURA
pag 95



Fascio doppio
Double beam

- _ Applique da parete in alluminio con diffusore in vetro per interni ed esterni
- _ Attacco GU10 per sorgenti LED max 2x7W (modello suggerito GU10 alta temperatura)
- _ Verniciatura a polveri resistente ai raggi UV

- _ Aluminum wall light with glass diffuser for indoors and outdoors
- _ GU10 base for LED light sources max 2x7W (suggested model high temperature GU10)
- _ UV-resistant powder coating



W	BASE		VARIANTE	CODICE	EAN	
-	GU10	-	 BIANCO / WHITE	GRANADA2B	8031453021900	1/20
-	GU10	-	 ANTRACITE / ANTHRACITE	GRANADA2G	8031453021917	1/20
-	GU10	-	 GRIGIO MARINA / LIGHT GREY	GRANADA2M	8031453021924	1/20

GRANADA2

BTL CATEGORIA SCONTO 24

Applique singola emissione / Single emission wall lamp

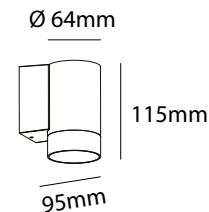

GU10 ALTA
TEMPERATURA
pag 95







Fascio singolo
Single beam

- _ Applique da parete in alluminio con diffusore in vetro per interni ed esterni
- _ Attacco GU10 per sorgenti LED max 7W (modello suggerito GU10 alta temperatura)
- _ Verniciatura a polveri resistente ai raggi UV

- _ Aluminum wall light with glass diffuser for indoors and outdoors
- _ GU10 base for LED light sources max 7W (suggested model high temperature GU10)
- _ UV-resistant powder coating



W	BASE		VARIANTE	CODICE	EAN	
-	GU10	-	 BIANCO / WHITE	GRANADA21B	8031453026349	1/20
-	GU10	-	 ANTRACITE / ANTHRACITE	GRANADA21G	8031453026332	1/20
-	GU10	-	 CORTEN	GRANADA21C	8031453026356	1/20

GRANADA2 DUO

BTL CATEGORIA SCONTO 24

Applique doppia emissione / Double emission wall lamp

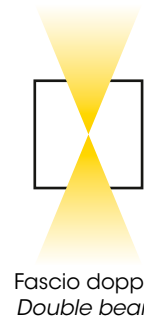
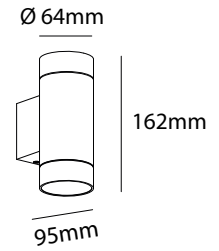
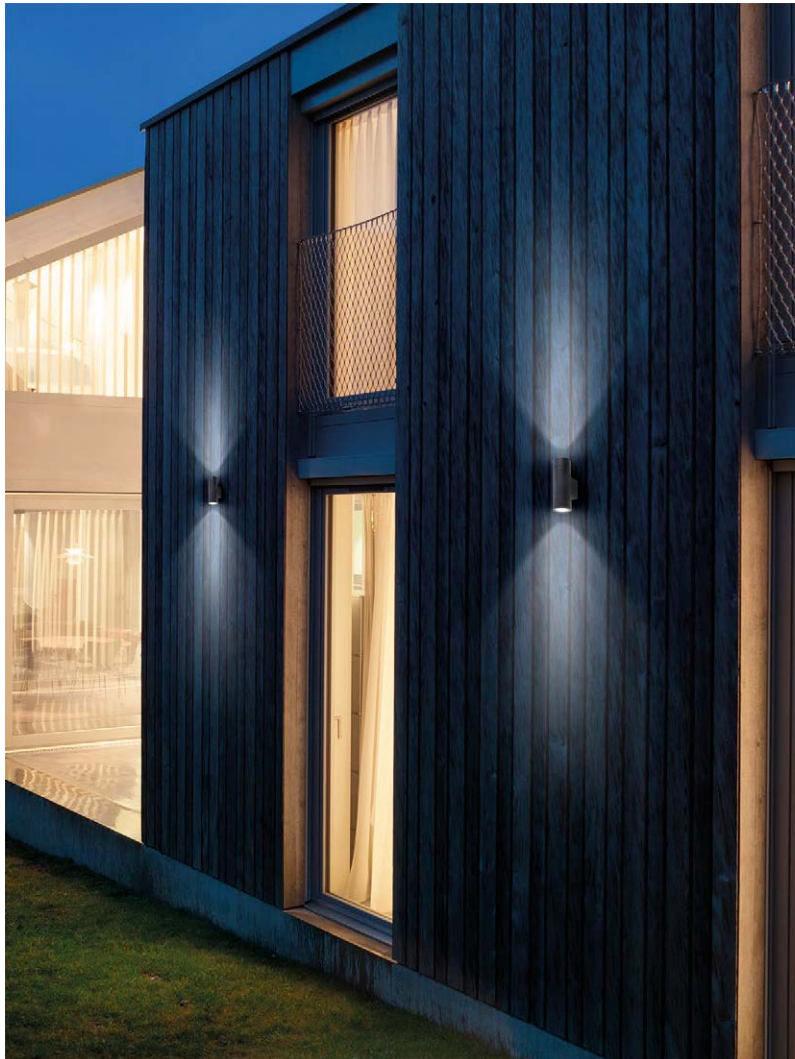

- _ Applique da parete in alluminio con diffusore in vetro per interni ed esterni
- _ Attacco GU10 per sorgenti LED max 2x7W (modello suggerito GU10 alta temperatura)
- _ Verniciatura a polveri resistente ai raggi UV

- _ Aluminum wall light with glass diffuser for indoors and outdoors
- _ GU10 base for LED light sources max 2x7W (suggested model high temperature GU10)
- _ UV-resistant powder coating



W	BASE		VARIANTE	CODICE	EAN	
-	GU10	-	BIANCO / WHITE	GRANADA22B	8031453026370	1/20
-	GU10	-	ANTRACITE / ANTHRACITE	GRANADA22G	8031453026363	1/20
-	GU10	-	CORTEN	GRANADA22C	8031453026387	1/20

Lantern a muro / Wall mounted lantern

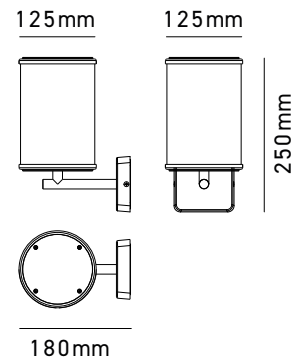

2 modalità di installazione
2 types of installation

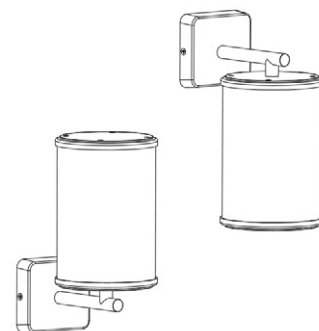

Questa applique è una rivisitazione in chiave moderna del classico concetto di lanterna da muro. La sua particolare progettazione permette l'installazione in configurazione up & down.

- _ Lanterna da parete con corpo in alluminio e diffusore in vetro
- _ Doppia possibilità di montaggio
- _ Attacco E27 per sorgenti LED max 20W

This wall light is a modern reinterpretation of the classic wall lantern concept. Its unique design allows for installation in an up & down configuration.

- _ *Wall lantern with aluminum body and glass diffuser*
- _ *Dual mounting options*
- _ *E27 base for LED light sources max 20W*



W	BASE		VARIANTE	CODICE	EAN	
-	E27	-	<input type="checkbox"/> BIANCA / WHITE	BARRELE27B	8031453033378	1/12
-	E27	-	<input checked="" type="checkbox"/> ANTRACITE / ANTHRACITE	BARRELE27G	8031453033385	1/12



BARREL

Applique / Wall lamp





Questa applique da parete richiama alla mente i cortili di un tempo, ideali per illuminare facciate, ingressi esterni e corridoi. Il corpo in acciaio e l'ampia cupola in vetro permettono alla lampadina scelta di influenzare significativamente atmosfera e luminosità.

This wall lamp evokes the courtyards of the past, making it ideal for illuminating facades, outdoor entrances, and corridors. The steel body and large glass dome allow the chosen bulb to significantly influence the atmosphere and brightness.

- _ Applique da parete in acciaio e diffusore in vetro
- _ Attacco E27 per sorgenti LED max 20W

- _ Wall lamp in steel with glass diffuser
- _ E27 base for LED light sources max 20W



W	BASE		VARIANTE	CODICE	EAN	
-	E27	-	<input type="checkbox"/> BIANCA / WHITE	JEREZ2E27B	8031453033392	1/4
-	E27	-	<input checked="" type="checkbox"/> ANTRACITE / ANTHRACITE	JEREZ2E27G	8031453033415	1/4
-	E27	-	<input checked="" type="checkbox"/> CORTEN	JEREZ2E27C	8031453033408	1/4

ARVIKA

BTL CATEGORIA SCONTO 24

Applique / Wall lamp



- _ Apparecchio da parete tradizionale in acciaio e diffusore in vetro per l'illuminazione del giardino, terrazze etc...
- _ Coperchio trasparente con vetro a bolla
- _ Monta una sorgente led con attacco E27 - 60W max

- _ Traditional wall luminaire made of aluminium with glass diffuser for the garden, terraces etc.
- _ Transparent glass dome diffuser
- _ Requires a LED light source with E27 base - 60W max



W	BASE		VARIANTE	CODICE	EAN	
-	E27	-	<input type="checkbox"/> BIANCO / WHITE	4107297	6435200157874	1/6
-	E27	-	<input checked="" type="checkbox"/> NERO / BLACK	4107298	6435200157898	1/6

MAIORCA

BTL CATEGORIA SCONTO 24

Applique / Wall lamp

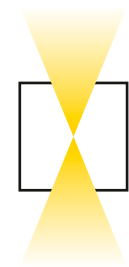
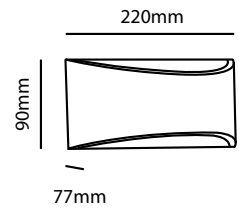
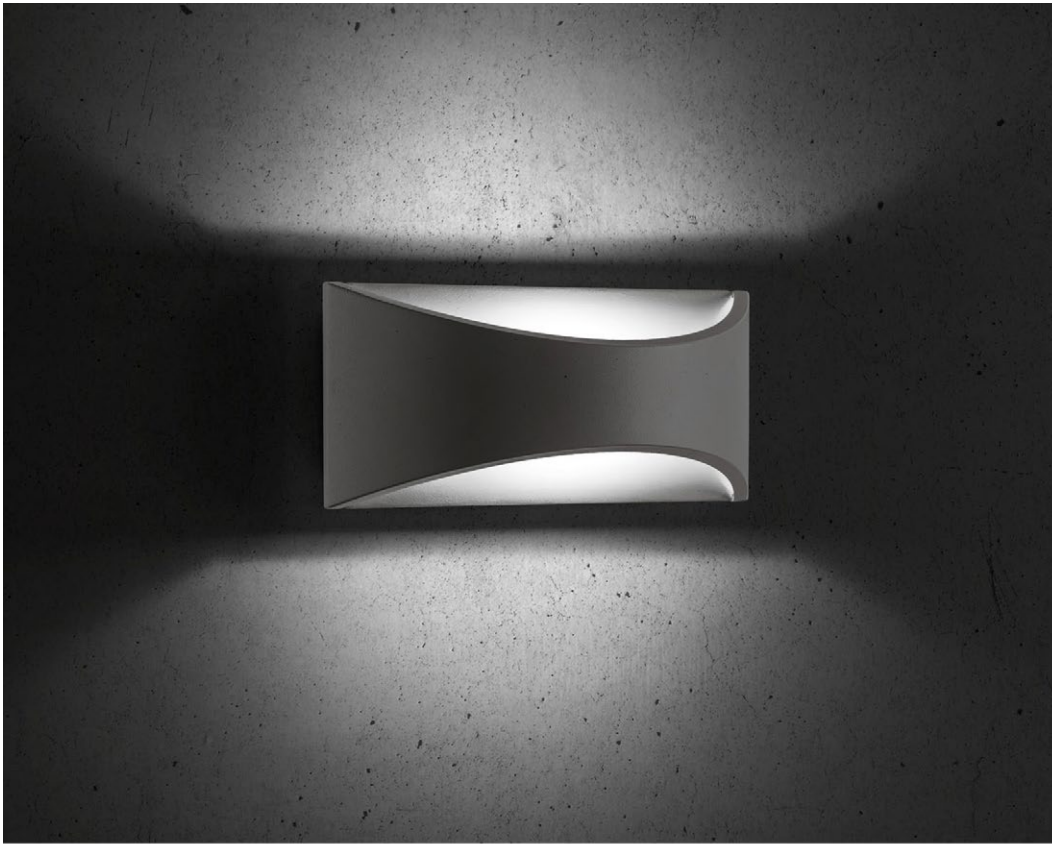

Fascio doppio
Double beam

- _ Applique da parete in alluminio per interni ed esterni
- _ Modulo LED integrato da 7W (illuminazione indiretta)
- _ CCT selezionabile

- _ Interior and exterior wall light in aluminium
- _ Built-in 7W LED module (indirect lighting)
- _ Selectable CCT



W	K	LUMEN APPARECCHIO lm	LUMEN SORGENTE lm		VARIANTE	CODICE	EAN		
7	<input type="checkbox"/> 3000 <input type="checkbox"/> 4000 <input type="checkbox"/> 5000	420	870	120°	<input type="checkbox"/> BIANCO / WHITE	MAIORCA6B	8031453021993	1/20	
7	<input type="checkbox"/> 3000 <input type="checkbox"/> 4000 <input type="checkbox"/> 5000	250	870	120°	<input checked="" type="checkbox"/> GRIGIO MARINA / LIGHT GREY	MAIORCA6M	8031453022006	1/20	



MAIORCA

SEGOVIA 1

BTL CATEGORIA SCONTO 24

Applique / Wall lamp

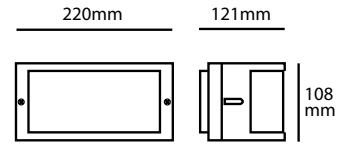

SEGOVIALED
modulo led di ricambio
spare led module
pag 226

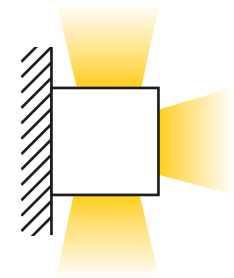

3 emissioni
3 emissions

*Solo per versione E27
only for E27 version

- _ Applique da parete con corpo in alluminio e diffusore in policarbonato
- _ Disponibile con modulo LED flicker-free sostituibile o attacco E27 max 20W LED
- _ Modulo 3000K opzionale

- _ Wall light with aluminium body and polycarbonate diffuser
- _ Available with replaceable flicker-free LED module or E27 base max 20W LED
- _ Optional 3000K module



W	BASE	K	LUMEN APPARECCHIO lm	LUMEN SORGENTE lm	△	VARIANTE	CODICE	EAN	📦	🌱	
10	-	□	4000	720	1000	180	□ BIANCO / WHITE	SEGOVIA110B	8031453021122	1/12	A t g E
10	-	□	4000	560	1000	180	■ ANTRACITE / ANTHRACITE	SEGOVIA110G	8031453020774	1/12	A t g E
10	-	□	4000	540	1000	180	■ CORTEN	SEGOVIA110C	8031453020781	1/12	A t g E
-	E27	-	-	-	-	-	□ BIANCO / WHITE	SEGOVIA1E27B	8031453020835	1/12	-
-	E27	-	-	-	-	-	■ ANTRACITE / ANTHRACITE	SEGOVIA1E27G	8031453021153	1/12	-
-	E27	-	-	-	-	-	■ GRIGIO MARINA / LIGHT GREY	SEGOVIA1E27M	8031453023751	1/12	-
-	E27	-	-	-	-	-	■ CORTEN	SEGOVIA1E27C	8031453020842	1/12	-



SEGOVIA 1

LAGOS 1

BTL CATEGORIA SCONTO 24

Applique / Wall lamp

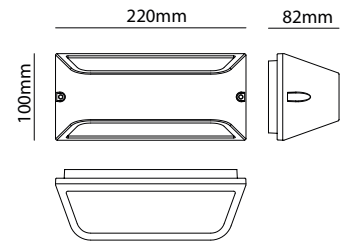

LAGOSLED
modulo led di ricambio / spare led module
pag 227



2 emissioni
2 emissions

- _ Applique da parete con corpo in alluminio e diffusore in policarbonato
- _ Disponibile con attacco E27 max 20W LED o modulo LED da 9W con CCT selezionabile

- _ Wall light with aluminium body and polycarbonate diffuser
- _ Available with E27 base max 20W LED or selectable CCT 9W LED module



W	BASE	K	LUMEN APPARECCHIO lm	LUMEN SORGENTE lm		VARIANTE	CODICE	EAN		
9	-	<input type="checkbox"/> 3000 <input type="checkbox"/> 4000 <input type="checkbox"/> 5500	575	1000	180	<input type="checkbox"/> BIANCO / WHITE	LAGOS110B	8031453031466	1/12	
9	-	<input type="checkbox"/> 3000 <input type="checkbox"/> 4000 <input type="checkbox"/> 5500	400	1000	180	<input checked="" type="checkbox"/> CORTEN	LAGOS110C	8031453031473	1/12	
9	-	<input type="checkbox"/> 3000 <input type="checkbox"/> 4000 <input type="checkbox"/> 5500	390	1000	180	<input checked="" type="checkbox"/> ANTRACITE / ANTHRACITE	LAGOS110G	8031453031480	1/12	
-	E27		-	-	-	<input type="checkbox"/> BIANCO / WHITE	LAGOS1E27B	8031453031497	1/12	-
-	E27		-	-	-	<input checked="" type="checkbox"/> CORTEN	LAGOS1E27C	8031453031503	1/12	-
-	E27		-	-	-	<input checked="" type="checkbox"/> ANTRACITE / ANTHRACITE	LAGOS1E27G	8031453031510	1/12	-
-	E27		-	-	-	<input type="checkbox"/> GRIGIO MARINA / LIGHT GREY	LAGOS1E27M	8031453031527	1/12	-
-	E27		-	-	-	<input checked="" type="checkbox"/> NERO / BLACK	LAGOS1E27N	8031453031664	1/12	-



LAGOS 1

LAGOS 2

BTL CATEGORIA SCONTO 24

Applique / Wall lamp

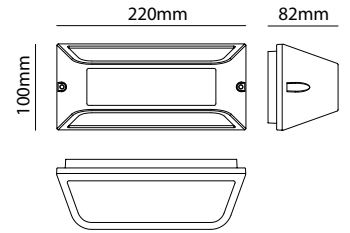

LAGOSLED
modulo led di ricambio / spare led module
pag 227

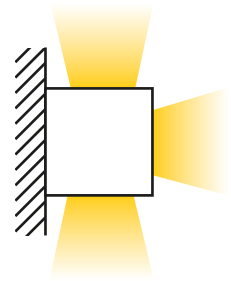

3 emissioni
3 emissions

- _ Applique da parete con corpo in alluminio e diffusore in policarbonato
- _ Disponibile con attacco E27 max 20W LED o modulo LED da 9W con CCT selezionabile

- _ Wall light with aluminium body and polycarbonate diffuser
- _ Available with E27 base max 20W LED or selectable CCT 9W LED module



W	BASE	K	LUMEN APPARECCHIO lm	LUMEN SORGENTE lm		VARIANTE	CODICE	EAN		
9	-	<input type="checkbox"/> 3000 <input type="checkbox"/> 4000 <input type="checkbox"/> 5500	595	1000	180	<input type="checkbox"/> BIANCO / WHITE	LAGOS210B	8031453031534	1/12	
9	-	<input type="checkbox"/> 3000 <input type="checkbox"/> 4000 <input type="checkbox"/> 5500	420	1000	180	<input checked="" type="checkbox"/> CORTEN	LAGOS210C	8031453031541	1/12	
9	-	<input type="checkbox"/> 3000 <input type="checkbox"/> 4000 <input type="checkbox"/> 5500	410	1000	180	<input checked="" type="checkbox"/> ANTRACITE / ANTHRACITE	LAGOS210G	8031453031558	1/12	
-	E27	-	-	-	-	<input type="checkbox"/> BIANCO / WHITE	LAGOS2E27B	8031453031565	1/12	-
-	E27	-	-	-	-	<input checked="" type="checkbox"/> CORTEN	LAGOS2E27C	8031453031572	1/12	-
-	E27	-	-	-	-	<input checked="" type="checkbox"/> ANTRACITE / ANTHRACITE	LAGOS2E27G	8031453031589	1/12	-
-	E27	-	-	-	-	<input checked="" type="checkbox"/> GRIGIO MARINA / LIGHT GREY	LAGOS2E27M	8031453031596	1/12	-
-	E27	-	-	-	-	<input checked="" type="checkbox"/> NERO / BLACK	LAGOS2E27N	8031453031671	1/12	-



Installazione orizzontale o verticale / horizontal or vertical installation

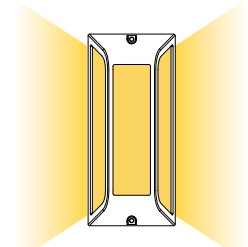
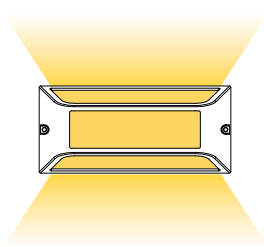

LAGOS 2

VALENCIA AGGIORNATO

BTL CATEGORIA SCONTO 24

Applique / Wall lamp

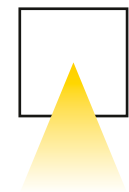
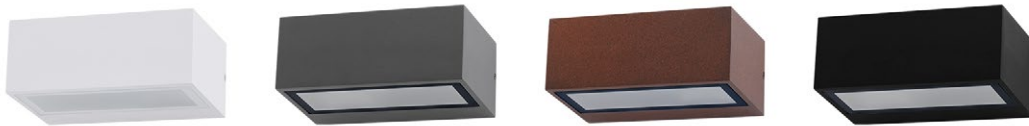
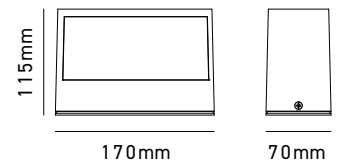

Fascio singolo
Single beam

- _ Applique da parete con corpo in alluminio e diffusore in vetro smerigliato
- _ Attacco E27 per sorgenti LED max 20W. Dimensione massima lampadina 60mm di diametro e 125mm di lunghezza
- _ Verniciatura a polveri resistente ai raggi UV

- _ Wall light with aluminum body and frosted glass diffuser
- _ E27 base for LED light sources max 20W. Maximum bulb size: 60mm in diameter and 125mm in length
- _ UV-resistant powder coating



W	BASE		VARIANTE	CODICE	EAN	
	E27	-	BIANCA / WHITE	VALENCIAE27B	8031453027490	1/12
	E27	-	ANTRACITE / ANTHRACITE	VALENCIAE27G	8031453027483	1/12
	E27	-	CORTEN	VALENCIAE27C	8031453027506	1/12
NEW	E27	-	NERO / BLACK	VALENCIAE27N	8031453033828	1/12



VALENCIA

VALENCIA 2 NEW

BTL CATEGORIA SCONTO 24

Applique doppia emissione / Double emission wall lamp

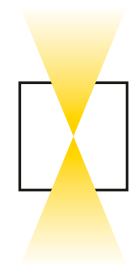
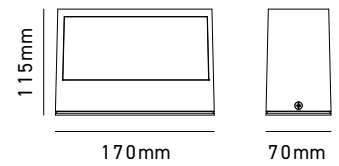

Fascio doppio
Double beam



Applique in alluminio con un affascinante fascio luminoso up & down, ideale per aggiungere profondità e atmosfera a qualsiasi ambiente. Una soluzione moderna per un'illuminazione decorativa e funzionale, perfetta per interni ed esterni

- _ Applique da parete con corpo in alluminio e diffusore in vetro smerigliato, doppia emissione
- _ Attacco E27 per sorgenti LED max 20W. Dimensione massima lampadina 55mm di diametro e 125mm di lunghezza
- _ Verniciatura a polveri resistente ai raggi UV

Aluminum wall light with a captivating up & down beam, ideal for adding depth and ambiance to any space. A modern solution for decorative and functional lighting, perfect for both indoor and outdoor use

- _ Wall-mounted applique with aluminum body and frosted glass diffuser, dual emission
- _ E27 base for LED light sources max 20W. Maximum bulb size: 55mm in diameter and 125mm in length
- _ UV-resistant powder coating



W	BASE		VARIANTE	CODICE	EAN	
-	E27	-	 BIANCO / WHITE	VALENCIA2E27B	8031453032876	1/12
-	E27	-	 ANTRACITE / ANTHRACITE	VALENCIA2E27G	8031453032890	1/12
-	E27	-	 CORTEN	VALENCIA2E27C	8031453032883	1/12



VALENCIA 2

VIGO 1

BTL CATEGORIA SCONTO 24

Applique / Wall lamp

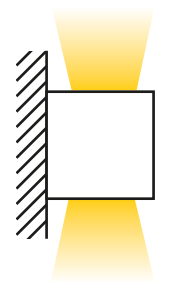
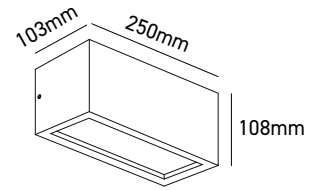



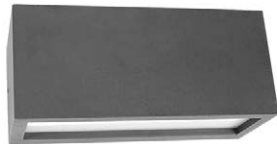

2 emissioni
2 emissions



- _ Applique da parete con corpo in alluminio e diffusore in policarbonato
- _ Attacco E27 per sorgenti LED max 20W

- _ Wall light with aluminium body and polycarbonate diffuser
- _ E27 base for LED light sources max 20W



W	BASE		VARIANTE	CODICE	EAN	
-	E27	-	 BIANCO / WHITE	VIGO1E27B	8031453026257	1/10
-	E27	-	 ANTRACITE / ANTHRACITE	VIGO1E27G	8031453026240	1/10
-	E27	-	 CORTEN	VIGO1E27C	8031453026264	1/10

VIGO 2

BTL CATEGORIA SCONTO 24

Applique / Wall lamp

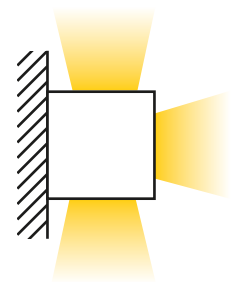
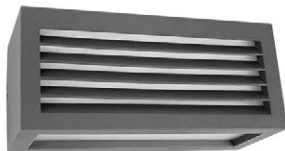
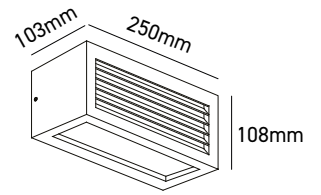





3 emissioni
3 emissions

- _ Applique da parete con corpo in alluminio e diffusore in policarbonato
- _ Attacco E27 per sorgenti LED max 20W

- _ Wall light with aluminium body and polycarbonate diffuser
- _ E27 base for LED light sources max 20W



W	BASE		VARIANTE	CODICE	EAN	
-	E27	-	 BIANCO / WHITE	VIGO2E27B	8031453026288	1/10
-	E27	-	 ANTRACITE / ANTHRACITE	VIGO2E27G	8031453026271	1/10
-	E27	-	 CORTEN	VIGO2E27C	8031453026295	1/10

VIGO 3

BTL CATEGORIA SCONTO 24

Applique / Wall lamp

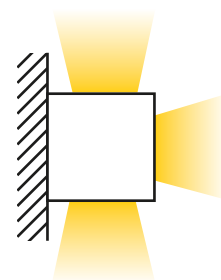
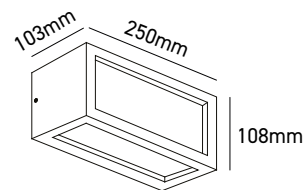





3 emissioni
3 emissions



- _ Applique da parete con corpo in alluminio e diffusore in policarbonato
- _ Attacco E27 per sorgenti LED max 20W

- _ Wall light with aluminium body and polycarbonate diffuser
- _ E27 base for LED light sources max 20W



W	BASE		VARIANTE	CODICE	EAN	
-	E27	-	 BIANCO / WHITE	VIGO3E27B	8031453026318	1/10
-	E27	-	 ANTRACITE / ANTHRACITE	VIGO3E27G	8031453026301	1/10
-	E27	-	 CORTEN	VIGO3E27C	8031453026325	1/10

VIGO 4

BTL CATEGORIA SCONTO 24

Applique / Wall lamp

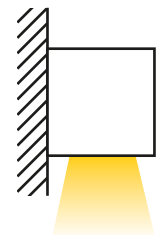
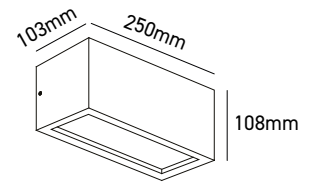

1 emissione
1 emission

- _ Applique da parete con corpo in alluminio e diffusore in policarbonato
- _ Attacco E27 per sorgenti LED max 20W

- _ Wall light with aluminium body and polycarbonate diffuser
- _ E27 base for LED light sources max 20W



W	BASE		VARIANTE	CODICE	EAN	
-	E27	-	BIANCO / WHITE	VIGO4E27B	8031453030940	1/10
-	E27	-	ANTRACITE / ANTHRACITE	VIGO4E27G	8031453030957	1/10
-	E27	-	CORTEN	VIGO4E27C	8031453030964	1/10





VIGO

Applique / Wall lamp

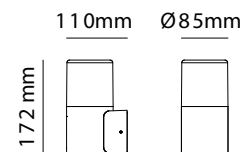





La semplicità si fa protagonista: una luce da parete che arricchisce i tuoi spazi con un'eleganza minimalista, discreta e moderna

- _ Applique da parete con corpo in alluminio e diffusore in policarbonato opalino
- _ Attacco E27 per sorgenti LED max 20W. Altezza massima 120mm

Simplicity takes center stage: a wall light that enriches your spaces with minimalist, discreet, and modern elegance

- _ Wall light with aluminum body and opal polycarbonate diffuser
- _ E27 base for LED light sources max 20W. Maximum bulb height 120mm



W	BASE		VARIANTE	CODICE	EAN	
-	E27	-	 ANTRACITE / ANTHRACITE	CADICEE27G	8031453027513	1/20
NEW	E27	-	 CORTEN	CADICEE27C	8031453032630	1/20

CADICE BOLLARD AGGIORNATO

BTL CATEGORIA SCONTO 24

Paletto da giardino / Outdoor bollard

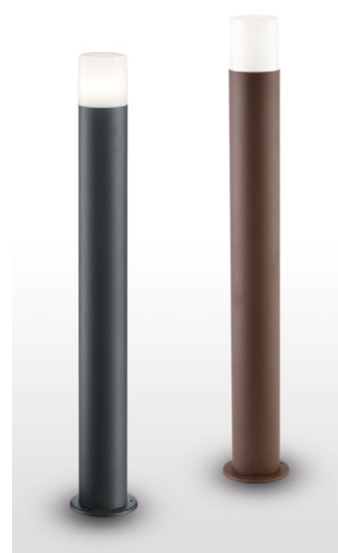
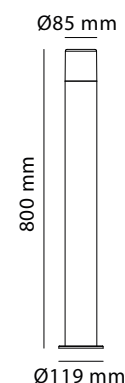





Un tocco di eleganza per il tuo giardino: linee minimaliste morbide ed arrotondate e un fascino senza tempo per illuminare con stile ogni angolo esterno

- _ Bollard in alluminio con diffusore in policarbonato opalino
- _ Attacco E27 per sorgenti LED max 20W. Altezza massima 120mm

A touch of elegance for your garden: soft, rounded minimalistic lines and timeless charm to illuminate every outdoor corner with style

- _ *Aluminum bollard with opal polycarbonate diffuser*
- _ *E27 base for LED light sources max 20W. Maximum bulb height 120mm*



W	BASE		VARIANTE	CODICE	EAN	
-	E27	-	 ANTRACITE / ANTHRACITE	CADICEE27GP	8031453027520	1/4
-	E27	-	 CORTEN	CADICEE27CP	8031453032647	1/4

NEW

KALLIO

BTL CATEGORIA SCONTO 24

Paletto da giardino / Outdoor bollard

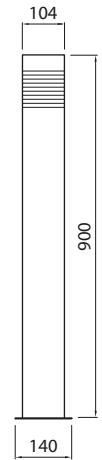
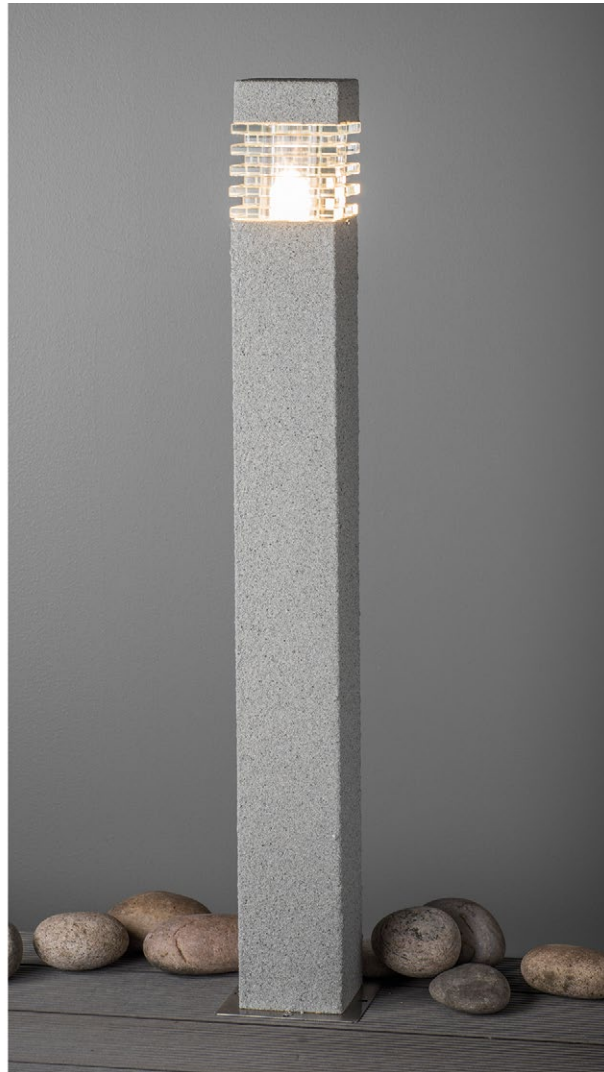

TUBOLARI T45
pag 87

- _ Corpo in acciaio inossidabile con diffusore in vetro
- _ Versione verniciato a polvere con finitura opaca
- _ Versione con rivestimento in pietra
- _ Attacco E27 max 20W. Dimensione massima sorgente: diametro 45mm e lunghezza 155mm

- _ Made from stainless steel with glass diffuser
- _ Version with matt powder-coated paint finish
- _ Version with stone cladding
- _ E27 base, max 20W. Maximum source size: 45mm diameter and 155mm length



W	BASE		VARIANTE	CODICE	EAN	
-	E27	-	ANTRACITE / ANTHRACITE	4116122	6435200188960	1/2
-	E27	-	GRIGIO CHIARO / LIGHT GREY	4107274	6435200147646	1/2



KALLIO

IBIZA

BTL CATEGORIA SCONTO 24

Paletto da giardino / Outdoor bollard

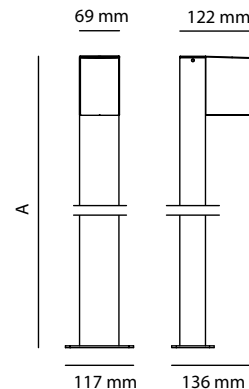

altezza / height A:
IBIZA5 - 500 mm
IBIZA10 - 1000 mm



GU10 ALTA
TEMPERATURA
pag 95





- _ Bollard in alluminio con diffusore in vetro
- _ Attacco GU10 per sorgenti LED max 7W (modello suggerito GU10 alta temperatura)
- _ Fissaggio su piastra con tasselli
- _ Verniciatura a polveri resistente ai raggi UV

- _ Aluminum bollard with glass diffuser
- _ GU10 base for LED light sources max 7W (suggested model high temperature GU10)
- _ Fixing on plate with dowels
- _ UV-resistant powder coating

IP 65

220-240V



W	BASE		VARIANTE	CODICE	EAN	
-	GU10	-	■ ANTRACITE / ANTHRACITE	IBIZA5G	8031453027537	1/6
-	GU10	-	■ CORTEN	IBIZA5C	8031453028855	1/6
-	GU10	-	■ ANTRACITE / ANTHRACITE	IBIZA10G	8031453027544	1/4
-	GU10	-	■ CORTEN	IBIZA10C	8031453028862	1/4

MERIDA

BTL CATEGORIA SCONTO 24

Paletto da giardino / Outdoor bollard

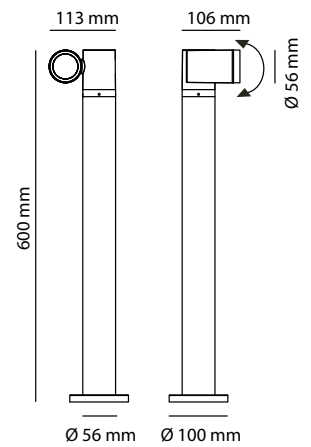

GU10 ALTA TEMPERATURA pag 95



- _ Bollard in alluminio con diffusore in vetro
- _ Testa orientabile
- _ Attacco GU10 per sorgenti LED max 7W (modello suggerito GU10 alta temperatura)
- _ Fissaggio su piastra con tasselli
- _ Verniciatura a polveri resistente ai raggi UV

- _ Aluminum bollard with glass diffuser
- _ Adjustable head
- _ GU10 base for LED light sources max 7W (suggested model high temperature GU10)
- _ Fixing on plate with dowels
- _ UV-resistant powder coating



W	BASE		VARIANTE	CODICE	EAN	
-	GU10	-	ANTRACITE / ANTHRACITE	MERIDA6G	8031453027551	1/8
-	GU10	-	CORTEN	MERIDA6C	8031453027575	1/8

LEON P

BTL CATEGORIA SCONTO 24

Lantern with palette / Lantern lamp with pole

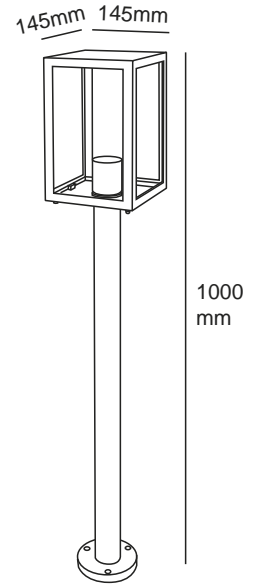

- _ Lanterna con paletto e corpo in acciaio colore RAL7024 e schermi in vetro
- _ Attacco E27 per sorgenti LED max 20W

- _ Lantern with pole made from steel color RAL 7024 with glass shades
- _ E27 base for LED light sources max 20W



W	BASE		VARIANTE	CODICE	EAN	
-	E27	-	■ ANTRACITE / ANTHRACITE	LEON1E27P	8031453025915	1/6

LEON

BTL CATEGORIA SCONTO 24

Lantern / Lantern lamp

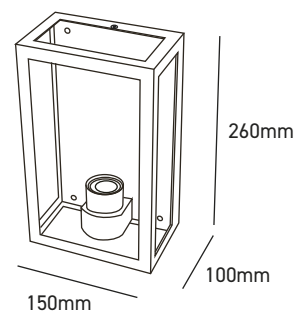

- _ Lanterna da parete con corpo in acciaio colore RAL7024 e schermi in vetro
- _ Attacco E27 per sorgenti LED max 20W

- _ Wall lantern made from steel color RAL7024 with glass diffusers
- _ E27 base for LED light sources max 20W



W	BASE		VARIANTE	CODICE	EAN	
-	E27	-	■ ANTRACITE / ANTHRACITE	LEON1E27	8031453025908	1/10

LEON 12 FRAME

NEW

BTL CATEGORIA SCONTO 24

Lanterna da muro / Wall mounted lantern

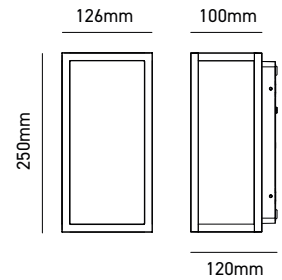

- _ Lanterna da parete con corpo in alluminio
- _ Modulo LED integrato da 13W
- _ Illuminazione indiretta grazie alla sorgente nascosta nel frame dell'apparecchio
- _ CCT selezionabile

- _ Aluminum body wall lantern
- _ 13W built-in LED module
- _ Indirect lighting thanks to the light source hidden within the fixture frame
- _ Selectable CCT



W	K	LUMEN APPARECCHIO lm	LUMEN SORGENTE lm		VARIANTE	CODICE	EAN		
13	<input type="checkbox"/> 3000 <input type="checkbox"/> 4000 <input type="checkbox"/> 5500	1000	1500	65°	<input type="checkbox"/> BIANCO / WHITE	LEON12FB	8031453034641	1/8	
13	<input type="checkbox"/> 3000 <input type="checkbox"/> 4000 <input type="checkbox"/> 5500	950	1500	65°	<input checked="" type="checkbox"/> CORTEN	LEON12FC	8031453034658	1/8	

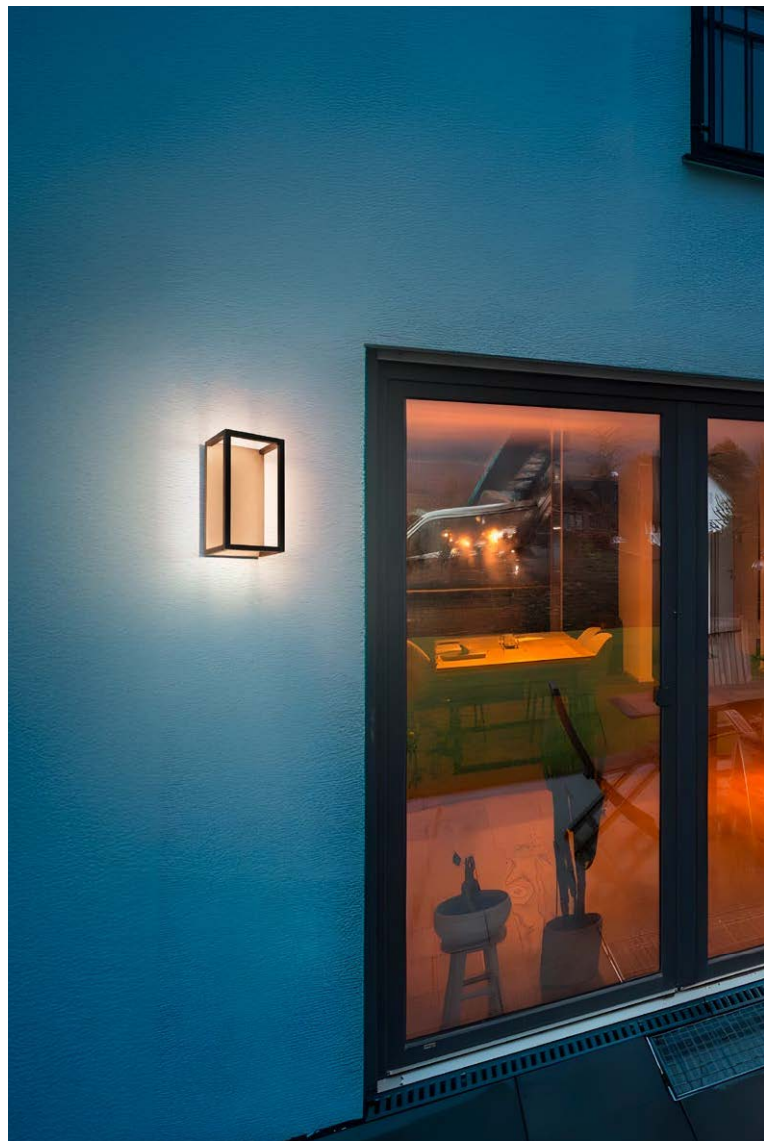

LEON12F

LEON 12

BTL CATEGORIA SCONTO 24

Lanterna da muro / Wall mounted lantern

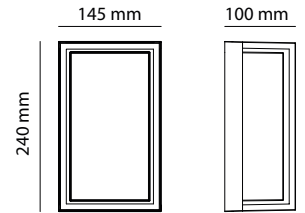

- _ Lanterna da parete con corpo in alluminio e diffusore in policarbonato
- _ Modulo LED integrato 12W
- _ CCT selezionabile

- _ Aluminum body and polycarbonate diffuser wall lantern
- _ 12W built-in LED module
- _ Selectable CCT



W	K	LUMEN APPARECCHIO lm	LUMEN SORGENTE lm		VARIANTE	CODICE	EAN		
12	<input type="checkbox"/> 3000 <input type="checkbox"/> 4000 <input type="checkbox"/> 5500	1200	1400	120°	<input type="checkbox"/> BIANCO / WHITE	LEON12B	8031453028824	1/8	
12	<input type="checkbox"/> 3000 <input type="checkbox"/> 4000 <input type="checkbox"/> 5500	1200	1400	120°	<input checked="" type="checkbox"/> CORTEN	LEON12C	8031453028831	1/8	



LEON 12

LEON 2 AGGIORNATO

BTL CATEGORIA SCONTO 24

Plafoniera / Ceiling lamp

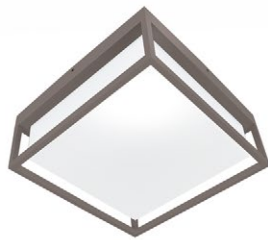
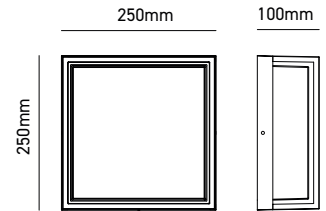



Plafoniera in alluminio progettata per combinare robustezza e stile in un'unica soluzione. Grazie alla protezione IP65, è ideale per ambienti esterni, mentre il design essenziale con doppia lampadina E27 aggiunge un tocco contemporaneo e versatile, adatta per soffitto e parete. Perfetta per ogni esigenza di illuminazione

Aluminum ceiling light designed to combine durability and style in a single solution. With IP65 protection, it is ideal for outdoor environments, while the sleek design with dual E27 bulbs adds a contemporary and versatile touch, suitable for both ceiling and wall mounting. Perfect for any lighting need

- _ Plafoniera con corpo in alluminio e diffusore in policarbonato
- _ Doppio attacco E27 per sorgenti LED max 20W. Diametro massimo lampadina 60mm.

- _ *Ceiling light with aluminum body and polycarbonate diffuser*
- _ *Double E27 socket for LED sources max 20W. Maximum bulb diameter 60mm.*



W	BASE		VARIANTE	CODICE	EAN	
-	E27	-	<input type="checkbox"/> BIANCO / WHITE	LEON2E27B	8031453030889	1/6
NEW	E27	-	<input checked="" type="checkbox"/> ANTRACITE / ANTHRACITE	LEON2E27G	8031453032517	1/6
-	E27	-	<input checked="" type="checkbox"/> CORTEN	LEON2E27C	8031453030896	1/6



LEON 2

Picchetto da giardino / Outdoor stake light

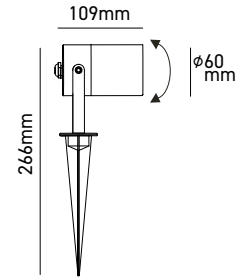

GU10 ALTA
TEMPERATURA
pag 95

Perfetta per valorizzare vialetti e angoli esterni illuminando con eleganza i dettagli più nascosti. Disponibile da oggi nella nuova colorazione verde RAL 6005

- Picchetto decorativo in alluminio per giardini o sentieri
- Inclinazione regolabile
- Cavo lunghezza 30cm con connettore IP68
- Attacco GU10 per sorgenti LED max 7W (modello suggerito GU10 alta temperatura)

Perfect for enhancing pathways and outdoor corners, elegantly illuminating the most hidden details. Now available in the new RAL 6005 green color

- Aluminium decorative stake light for gardens or paths
- Adjustable head
- Supplied with 30 cm cable and IP68 connector
- GU10 base for LED light sources max 7W (suggested model high temperature GU10)



W	BASE		VARIANTE	CODICE	EAN	
-	GU10	-	■ ANTRACITE / ANTHRACITE	SPIKY1	8031453025922	1/20
-	GU10	-	■ CORTEN	SPIKY1C	8031453027568	1/20
NEW	GU10	-	■ VERDE / GREEN	SPIKY1V	8031453032715	1/20

SPIKY2

BTL CATEGORIA SCONTO 24

Picchetto da giardino / Outdoor stake light

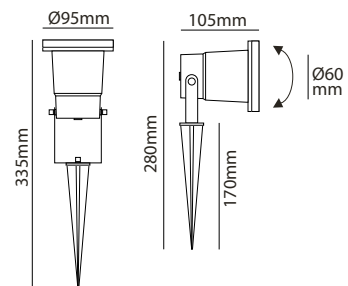



GU10 ALTA
TEMPERATURA
pag 95



- _ Picchetto decorativo in alluminio per giardini o sentieri
- _ Inclinazione regolabile
- _ Cavo lunghezza 30cm con connettore IP68
- _ Attacco GU10 per sorgenti LED max 7W (modello suggerito GU10 alta temperatura)
- _ GU10 altezza max 55mm

- _ Aluminium decorative stake light for gardens or paths
- _ Adjustable head
- _ Supplied with 30 cm cable and IP68 connector
- _ GU10 base for LED light sources max 7W (suggested model high temperature GU10)
- _ GU10 max height 55mm



W	BASE		VARIANTE	CODICE	EAN	
-	GU10	-	■ ANTRACITE / ANTHRACITE	SPIKY2	8031453025939	1/20

Picchetto da giardino regolabile / Adjustable outdoor stake light

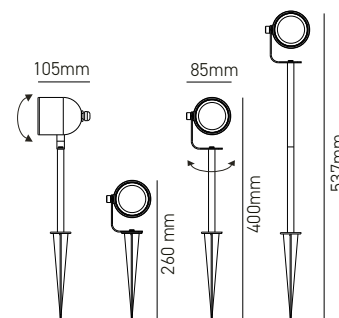

GU10 ALTA TEMPERATURA
pag 95

Picchetto compatto con altezza regolabile, resistente alle intemperie, si integra perfettamente in ogni contesto outdoor. Una soluzione ideale per valorizzare giardini, vialetti e aree esterne.

- _ Picchetto decorativo in alluminio per giardini o sentieri
- _ Inclinazione regolabile
- _ Cavo lunghezza 50cm con connettore IP68
- _ Doppio stelo incluso per regolare l'altezza a piacimento
- _ Attacco GU10 per sorgenti LED max 7W e altezza max 60mm (modello suggerito GU10 alta temperatura)

Compact stake with adjustable height, weather-resistant, and perfectly integrates into any outdoor setting. An ideal solution to enhance gardens, pathways, and outdoor areas.

- _ Aluminium decorative stake for gardens or pathways
- _ Adjustable tilt
- _ 50cm cable with IP68 connector
- _ Double stem included to adjust the height as desired
- _ GU10 socket for LED sources max 7W and max height 60mm (suggested model: high-temperature GU10)



W	BASE		VARIANTE	CODICE	EAN	
-	GU10	-	CORTEN	SPIKY3LC	8031453033255	1/12
-	GU10	-	NERO / BLACK	SPIKY3LN	8031453033248	1/12
-	GU10	-	VERDE / GREEN	SPIKY3LV	8031453033361	1/12



SPIKY3

ARONA 1

BTL CATEGORIA SCONTO 24

Segnapasso CCT / CCT step light

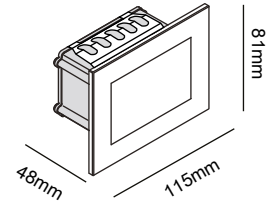
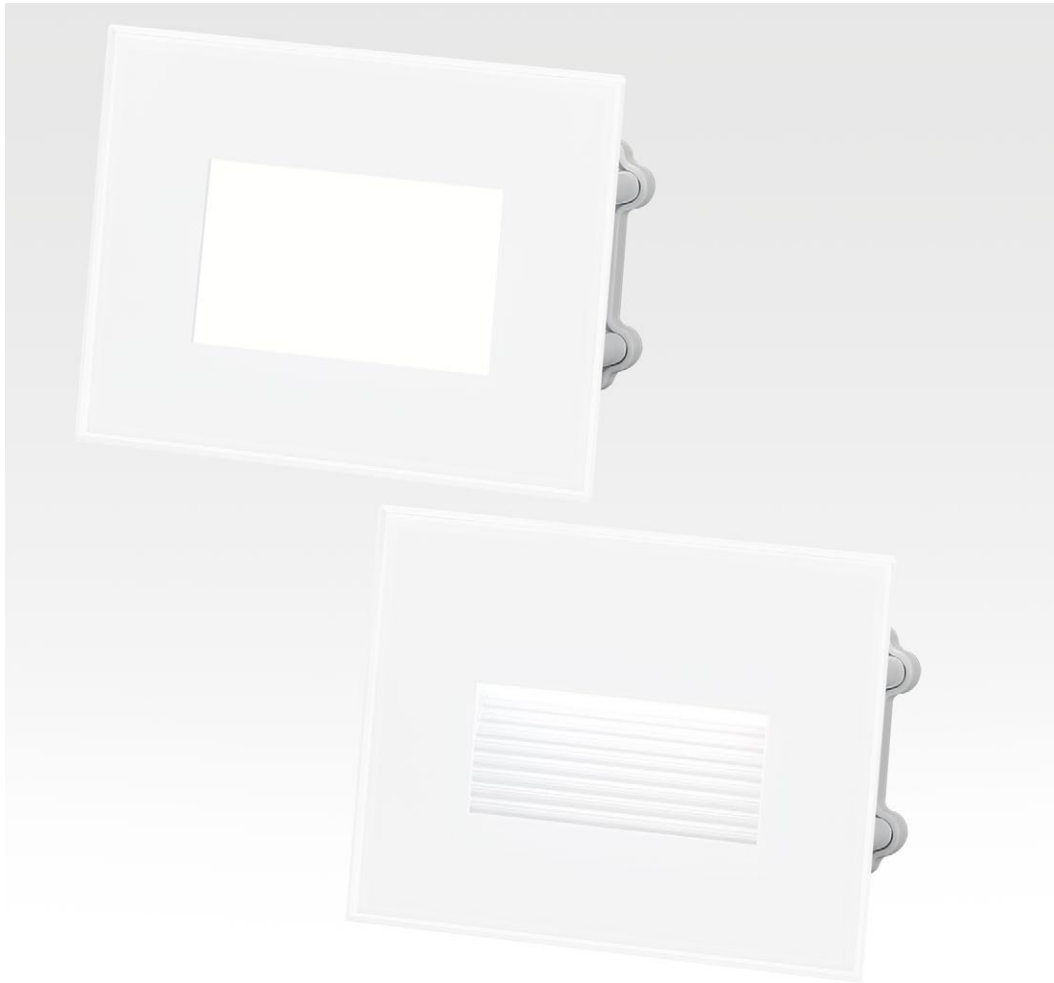

- _ Segnapasso in alluminio pressofuso bianco con diffusore in vetro
- _ Disponibile con fascio simmetrico ed asimmetrico
- _ Modulo LED integrato da 4,5W
- _ CCT selezionabile
- _ Compatibile con scatola 503 (non inclusa)

- _ White die-cast aluminum steplight with glass diffuser
- _ Available with symmetrical and asymmetrical beam
- _ Built-in 4,5W LED module
- _ Selectable CCT
- _ Compatible with 503 formwork (not included)



W	K	LUMEN APPARECCHIO lm	LUMEN SORGENTE lm		VARIANTE	CODICE	EAN		
4,5	3000	240	320	120°	SIMMETRICO / SYMMETRICAL	ARONA301	8031453027131	1/40	
	4000								
	6000								
4,5	3000	150	320	38°	ASIMMETRICO / ASYMMETRICAL	ARONA302	8031453027148	1/40	
	4000								
	6000								

ARONA 2 AGGIORNATO

BTL CATEGORIA SCONTO 24

Segnapasso CCT / CCT step light

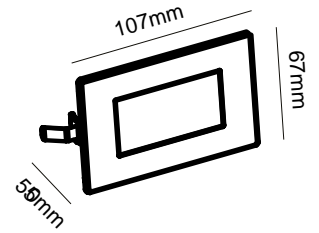
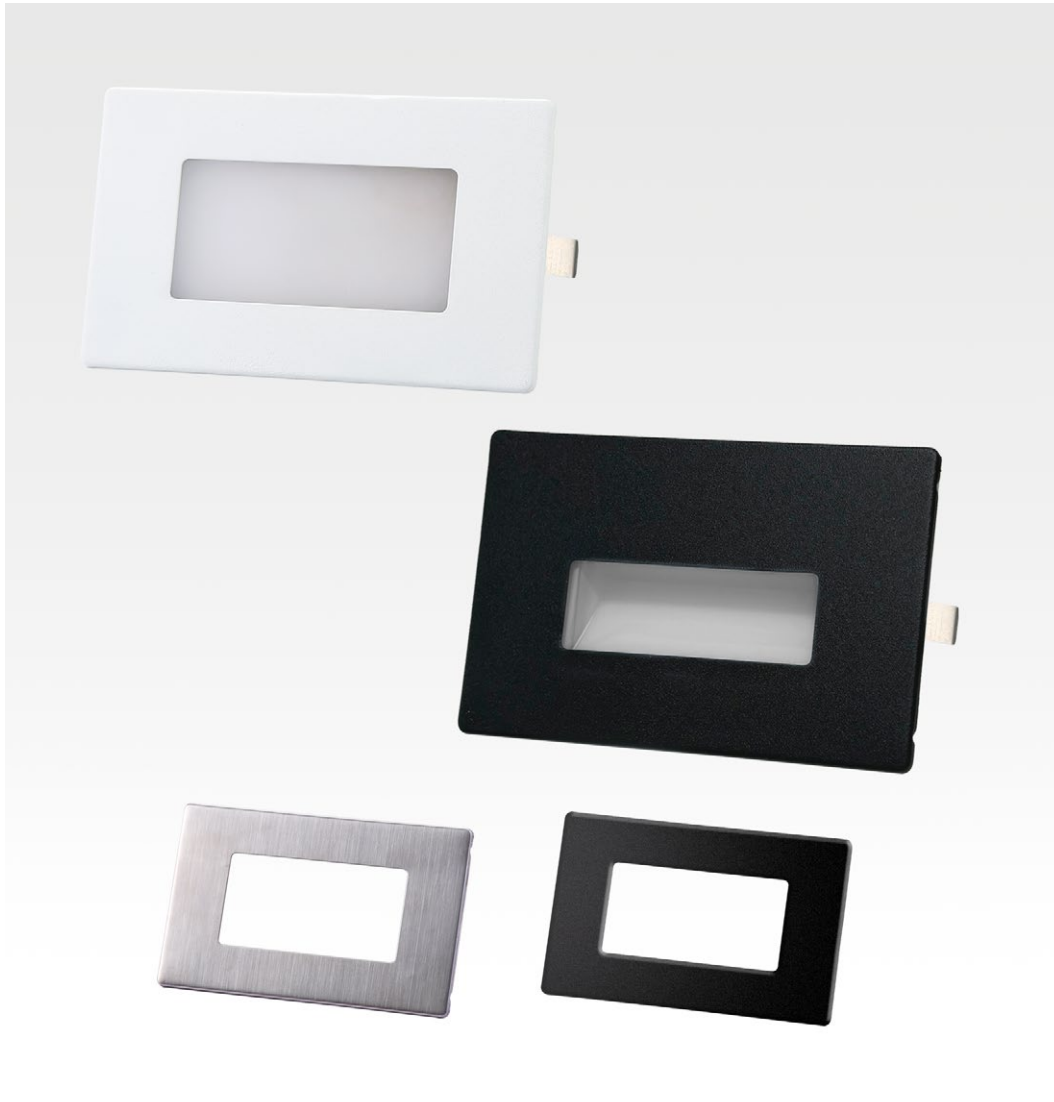

- _ Segnapasso in policarbonato
- _ Cover metalliche in dotazione colore bianco, nero e acciaio spazzolato
- _ Disponibile con fascio simmetrico ed asimmetrico
- _ Variante con fascio simmetrico disponibile anche con modulo di emergenza 2 h di autonomia - IP20
- _ CCT selezionabile
- _ Compatibile con scatola 503 (non inclusa)

- _ Polycarbonate steplight
- _ Metal covers supplied in white, black and brushed steel
- _ Available with symmetrical and asymmetrical beam
- _ Symmetrical beam version also available with emergency module providing 2 hours of autonomy - IP20 rated
- _ Selectable CCT
- _ Compatible with 503 formwork (not included)

IP 65
220-240V
25.000h
-20°+45°
CCT
EMERGENCY
2h

W	K	LUMEN APPARECCHIO lm	LUMEN SORGENTE lm	Beam Angle	VARIANTE	CODICE	EAN	Box	Energy
2,5	3000	150	240	120°	-	ARONA303	8031453027155	1/100	A F
	4000								
	6000								
3	3000	150	170	120°	EMERGENZA / EMERGENCY	ARONA303EM	8031453027162	1/60	A G
	4000								
	6000								
2,5	3000	150	300	38°	ASIMMETRICO / ASYMMETRIC	ARONA304	8031453034498	1/100	A E
	4000								
	6000								

NEW

ARONA 3

BTL CATEGORIA SCONTO 24

Segnapasso CCT / CCT step light

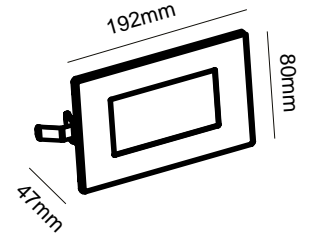

- _ Segnapasso in policarbonato
- _ Disponibile anche in variante con modulo di emergenza 2 h di autonomia
- _ CCT selezionabile
- _ Compatibile con scatola 506 (non inclusa)

- _ Polycarbonate steplight
- _ Also available in emergency light version - autonomy period 2h
- _ Selectable CCT
- _ Compatible with 506 formwork (not included)



W	K	LUMEN APPARECCHIO lm	LUMEN SORGENTE lm		VARIANTE	CODICE	EAN		
4,5	<input type="checkbox"/> 3000 <input type="checkbox"/> 4000 <input type="checkbox"/> 6000	320	430	120°	<input type="checkbox"/> BIANCO / WHITE	ARONA601	8031453027179	1/50	
3,5	<input type="checkbox"/> 3000 <input type="checkbox"/> 4000 <input type="checkbox"/> 6000	140	180	120°	EMERGENZA / EMERGENCY *	ARONA601EM	8031453027186	1/50	



ARONA

BILBAO 3 SQUARED AGGIORNATO

BTL CATEGORIA SCONTO 24

Segnapasso CCT / CCT step light

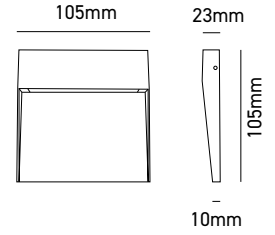

Segnapasso dal design elegante e discreto, illumina e sottolinea ogni percorso impreziosendo ambienti classici e moderni

Step light with an elegant and understated design, illuminating and accentuating any pathway while enhancing both classic and modern settings

- _ Segnapasso quadrato in pressofusione di alluminio per applicazione a parete
- _ Modulo LED integrato da 3W
- _ CCT selezionabile

- _ Square steplight in die-cast aluminum for wall application
- _ Built-in 3W LED
- _ Selectable CCT



W	K	LUMEN APPARECCHIO lm	LUMEN SORGENTE lm		VARIANTE	CODICE	EAN		
3	<input type="checkbox"/> 3000 <input type="checkbox"/> 4000 <input type="checkbox"/> 5000	145	335	64°	<input type="checkbox"/> BIANCO / WHITE	BILBAO3BQ	8031453022655	1/20	
3	<input type="checkbox"/> 3000 <input type="checkbox"/> 4000 <input type="checkbox"/> 5000	90	335	64°	<input checked="" type="checkbox"/> ANTRACITE / ANTHRACITE	BILBAO3GQ	8031453022662	1/20	
3	<input type="checkbox"/> 3000 <input type="checkbox"/> 4000 <input type="checkbox"/> 5000	100	335	64°	<input type="checkbox"/> GRIGIO MARINA / LIGHT GREY	BILBAO3MQ	8031453022679	1/20	
NEW	<input type="checkbox"/> 3000 <input type="checkbox"/> 4000 <input type="checkbox"/> 5000	100	335	64°	<input checked="" type="checkbox"/> CORTEN	BILBAO3CQ	8031453032852	1/20	

BILBAO 6 SQUARED

AGGIORNATO

BTL CATEGORIA SCONTO 24

Segnapasso CCT / CCT step light

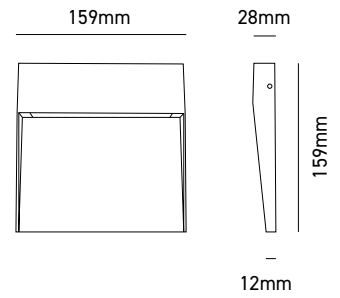

Segnapasso dal design elegante e discreto, illumina e sottolinea ogni percorso impreziosendo ambienti classici e moderni

Step light with an elegant and understated design, illuminating and accentuating any pathway while enhancing both classic and modern settings

- Segnapasso quadrato in pressofusione di alluminio per applicazione a parete
- Modulo LED integrato da 6,5W
- CCT selezionabile

- Square steplight in die-cast aluminum for wall application
- Built-in 6,5W LED module
- Selectable CCT



W	K	LUMEN APPARECCHIO lm	LUMEN SORGENTE lm		VARIANTE	CODICE	EAN				
6,5	<input type="checkbox"/> 3000 <input type="checkbox"/> 4000 <input type="checkbox"/> 5000	300	675	72°	<input type="checkbox"/> BIANCO / WHITE	BILBAO6BQ	8031453032869	1/20			
6,5	<input type="checkbox"/> 3000 <input type="checkbox"/> 4000 <input type="checkbox"/> 5000	255	675	72°	<input checked="" type="checkbox"/> ANTRACITE / ANTHRACITE	BILBAO6GQ	8031453022723	1/20			
6,5	<input type="checkbox"/> 3000 <input type="checkbox"/> 4000 <input type="checkbox"/> 5000	305	675	72°	<input type="checkbox"/> GRIGIO MARINA / LIGHT GREY	BILBAO6MQ	8031453022730	1/20			
6,5	<input type="checkbox"/> 3000 <input type="checkbox"/> 4000 <input type="checkbox"/> 5000	290	675	72°	<input checked="" type="checkbox"/> CORTEN	BILBAO6CQ	8031453022716	1/20			

SORIA RETTANGOLARE

BTL CATEGORIA SCONTO 24

Segnapasso CCT / CCT step light

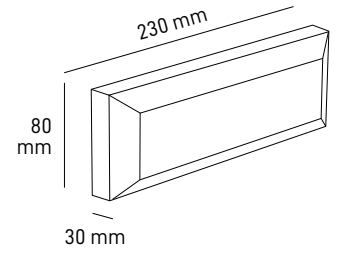

- _ Segnapasso in ABS e policarbonato per applicazione a parete
- _ Cover bianca e antracite in dotazione
- _ Disponibile con fascio simmetrico e asimmetrico
- _ Modulo LED integrato da 4W
- _ CCT selezionabile

- _ Steplight in ABS and polycarbonate for wall application
- _ White and anthracite cover supplied
- _ Available with symmetrical and asymmetrical beam
- _ Built-in 4W LED module
- _ Selectable CCT



W	K	LUMEN APPARECCHIO lm	LUMEN SORGENTE lm		VARIANTE	CODICE	EAN		
4	<input type="checkbox"/> 3000 <input type="checkbox"/> 4000 <input type="checkbox"/> 6500	390	440	120°	SIMMETRICO / SYMMETRICAL	SORIA4	8031453027438	1/20	
4	<input type="checkbox"/> 3000 <input type="checkbox"/> 4000 <input type="checkbox"/> 6500	300	440	38°	ASIMMETRICO / ASYMMETRICAL	SORIA4A	8031453027445	1/20	

SORIA QUADRATO

BTL CATEGORIA SCONTO 24

Segnapasso CCT / CCT step light

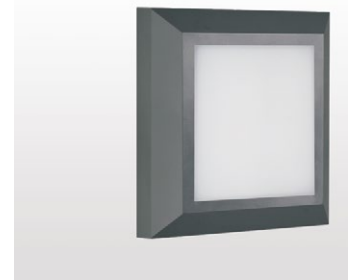
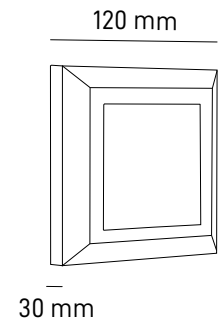

- _ Segnapasso in ABS e policarbonato per applicazione a parete
- _ Cover bianca e antracite in dotazione
- _ Modulo LED integrato da 4W
- _ CCT selezionabile

- _ Steplight in ABS and polycarbonate for wall application
- _ White and anthracite cover supplied
- _ Built-in 4W LED module
- _ Selectable CCT



W	K	LUMEN APPARECCHIO lm	LUMEN SORGENTE lm		VARIANTE	CODICE	EAN		
4	<input type="checkbox"/> 3000 <input type="checkbox"/> 4000 <input type="checkbox"/> 6500	330	450	120°	-	SORIA4Q	8031453027452	1/20	

ARONA 200

BTL CATEGORIA SCONTO 24

Segnapasso CCT per cover magnetica / CCT step light for magnetic cover



Scatola tonda inclusa
Round box included

- _ Segnapasso in policarbonato e alluminio
- _ Cover magnetica in alluminio sostituibile ((da ordinare separatamente)
- _ Disponibile in 4 colori e 2 forme
- _ Modulo led integrato da 1,5W
- _ CCT selezionabile
- _ Compatibile con scatola tonda standard europeo (in dotazione)
- _ Polycarbonate and aluminum steplight
- _ Replaceable magnetic aluminum cover (order separately)
- _ 4 colors and 2 shapes available
- _ Built-in 1.5W led module
- _ Selectable CCT
- _ Compatible with European round standard formwork (included)



W	K	LUMEN APPARECCHIO lm	LUMEN SORGENTE lm		VARIANTE	CODICE	EAN		
1,5	<input type="checkbox"/> 3000 <input type="checkbox"/> 4000 <input type="checkbox"/> 6000	80	100	38°	-	ARONA200	8031453029005	1	
					<input type="checkbox"/>	COVER - OVALE BIANCO / WHITE OVAL	ARONA200FOB	8031453029050	1
					<input type="checkbox"/>	COVER - OVALE GRIGIO CHIARO / LIGHT GREY OVAL	ARONA200FOG	8031453029081	1
					<input type="checkbox"/>	COVER - OVALE GRIGIO SIDERALE / SPACE GRAY OVAL	ARONA200FOA	8031453029074	1
					<input type="checkbox"/>	COVER - OVALE NERO / BLACK OVAL	ARONA200FON	8031453029067	1
ACCESSORI ACCESSORIES					<input type="checkbox"/>	COVER - RETTANGOLARE BIANCO / WHITE RECTANGULAR	ARONA200FRB	8031453029012	1
					<input type="checkbox"/>	COVER - RETTANGOLARE GRIGIO CHIARO / LIGHT GREY RECTANGULAR	ARONA200FRG	8031453029043	1
					<input type="checkbox"/>	COVER - RETTANGOLARE GRIGIO SIDERALE / SPACE GREY RECTANGULAR	ARONA200FRA	8031453029036	1
					<input type="checkbox"/>	COVER - RETTANGOLARE NERO / BLACK RECTANGULAR	ARONA200FRN	8031453029029	1
						SCATOLA TONDA STANDARD EUROPEO / EUROPEAN STANDARD ROUND BOX	ARONAB	8031453029098	1

ARONA 300

BTL CATEGORIA SCONTO 24

Segnapasso CCT per cover magnetica / CCT step light for magnetic cover

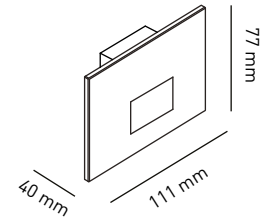
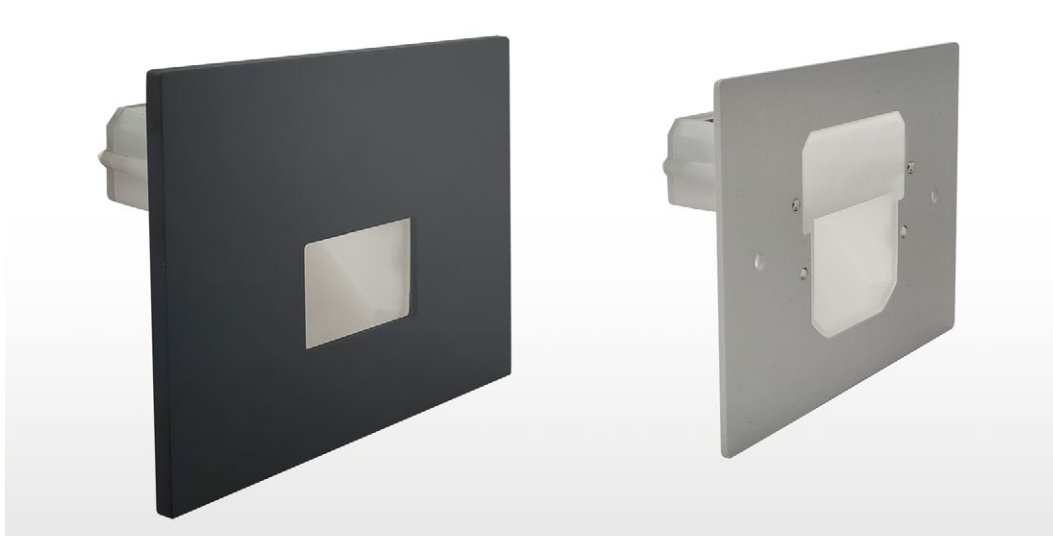

- _ Segnapasso in policarbonato e alluminio
- _ Cover magnetica in alluminio sostituibile (da ordinare separatamente)
- _ Disponibile in 4 colori e 2 forme
- _ Modulo led integrato da 1,5W
- _ CCT selezionabile
- _ Compatibile con scatola 503 (non inclusa)

- _ Polycarbonate and aluminum steplight
- _ Replaceable magnetic aluminum cover (order separately)
- _ 4 colors and 2 shapes available
- _ Built-in 1.5W led module
- _ Selectable CCT
- _ Compatible with 503 formwork (not included)



W	K	LUMEN APPARECCHIO lm	LUMEN SORGENTE lm		VARIANTE	CODICE	EAN		
1,5	<input type="checkbox"/> 3000 <input type="checkbox"/> 4000 <input type="checkbox"/> 6000	80	100	38°	-	ARONA300	8031453028916	1	
		<input type="checkbox"/>	COVER - OVALE BIANCO / WHITE OVAL			ARONA300FOB	8031453028961	1	
		<input type="checkbox"/>	COVER - OVALE GRIGIO CHIARO / LIGHT GREY OVAL			ARONA300FOG	8031453028992	1	
		<input type="checkbox"/>	COVER - OVALE GRIGIO SIDERALE / SPACE GRAY OVAL			ARONA300FOA	8031453028985	1	
		<input type="checkbox"/>	COVER - OVALE NERO / BLACK OVAL			ARONA300FON	8031453028978	1	
ACCESSORI ACCESSORIES			<input type="checkbox"/>	COVER - RETTANGOLARE BIANCO / WHITE RECTANGULAR		ARONA300FRB	8031453028923	1	
		<input type="checkbox"/>	COVER - RETTANGOLARE GRIGIO CHIARO / LIGHT GREY RECTANGULAR			ARONA300FRG	8031453028954	1	
		<input type="checkbox"/>	COVER - RETTANGOLARE GRIGIO SIDERALE / SPACE GREY RECTANGULAR			ARONA300FRA	8031453028947	1	
		<input type="checkbox"/>	COVER - RETTANGOLARE NERO / BLACK RECTANGULAR			ARONA300FRN	8031453028930	1	





ARONA 200 / 300

HOLM

BTL CATEGORIA SCONTO 24

Segnapasso calpestabile / Walkover light

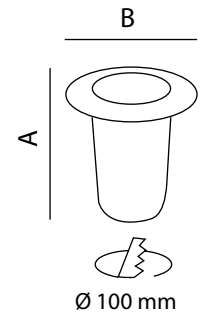

Dimensioni	A	B
1	125	118,6
2	139	118,6



GU10 ALTA
TEMPERATURA
pag 95

- _ Apparecchio segnapasso calpestabile da terrazza adattabile ad ambienti interni ed esterni
- _ Utilizzato per illuminazione d'accento
- _ Disponibile in due versioni con fascio singolo o tre fasci laterali
- _ Colorazione anello frontale; fascio singolo: acciaio inossidabile; tre fasci: antracite
- _ Attacco GU10 per sorgenti LED max 6W (modello suggerito GU10 alta temperatura)
- _ Non necessita di cassa

- _ *Walkover lights for terraces suitable for indoor or outdoor environments*
- _ *Used for accent lighting*
- _ *Available in two versions with single or 3-way side beams*
- _ *Top ring colour; single beam: stainless steel; three beams: anthracite*
- _ *GU10 base for LED light sources max 6W (suggested model high temperature GU10)*
- _ *No recess required*



W	BASE	MISURE	VARIANTE	CODICE	EAN	
-	GU10	1	ACCIAIO / STEEL	4510237	6435200209023	1/10
-	GU10	2	ANTRACITE / ANTHRACITE	4510253	6435200217288	1/10

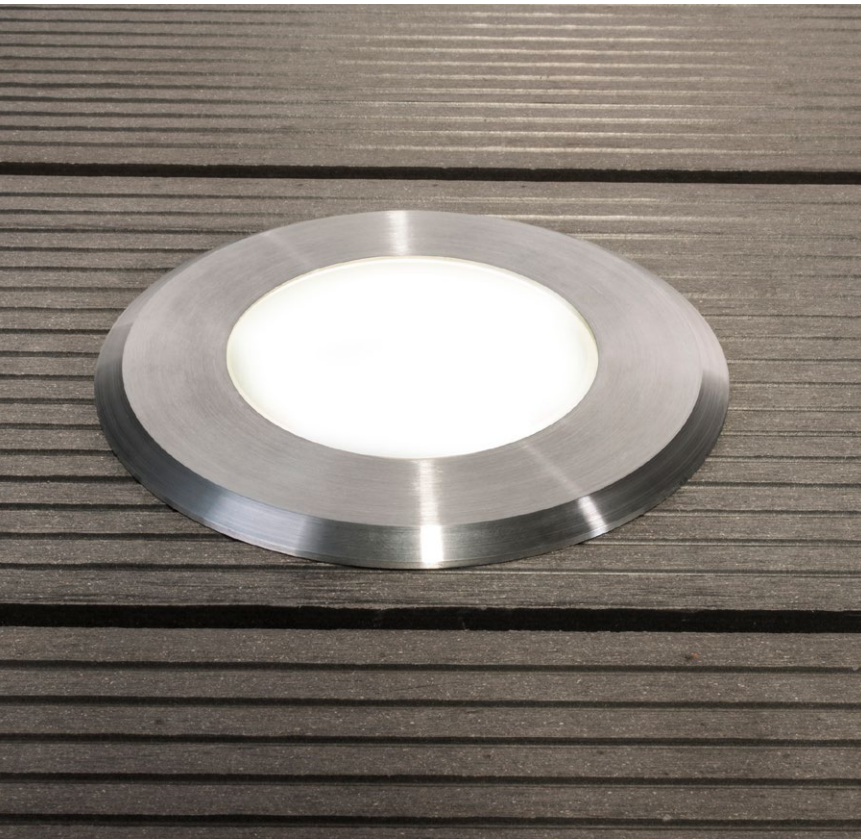

HOLM 4510237



HOLM 4510253

AITONA

BTL CATEGORIA SCONTO 24

Segnapasso calpestabile / Walkover light

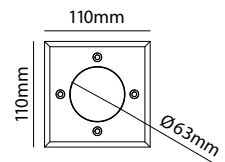
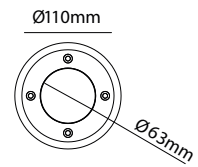
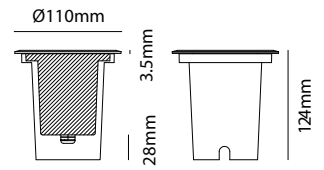

GU10 ALTA
TEMPERATURA
pag 95

- _ Apparecchio segnapasso calpestabile per esterno
- _ Disponibile in due versioni, tondo e quadrato, con ghiera in acciaio inox spazzolato
- _ Attacco GU10 per sorgenti LED max 7W (modello suggerito GU10 alta temperatura)
- _ Controcassa di installazione inclusa
- _ Doppio pressacavo per collegamento in serie

- _ Walkover light fixture for outdoors.
- _ Available in two versions, round and square, with brushed stainless steel ring
- _ GU10 base for LED light sources max 7W (suggested model high temperature GU10)
- _ Outer case included
- _ Double cable gland for series connection



W	BASE		VARIANTE	CODICE	EAN	
-	GU10	-	QUADRATO / SQUARED	AITONA7Q	8031453030766	1/20
-	GU10	-	ROTONDO / ROUNDED	AITONA7R	8031453030759	1/20



AITONA

GARDA DESK

BTL CATEGORIA SCONTO 24

Lampada da tavolo per esterni / Outdoor table lamp

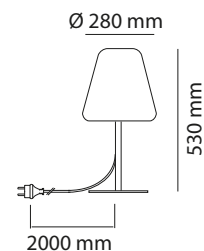

- _ Lampada da tavolo dall'aspetto moderno adatta sia ad usi all'interno che aree esterne come terrazzi, balconi e giardini.
- _ Corpo realizzato in acciaio verniciato a polvere di colore antracite RAL 7024 e diffusore in polietilene con protezione UV di colore bianco.
- _ Cavo di alimentazione da 2m H05RN-F 2X1,0 mm² dotato di spina Schuko (16A 250V).
- _ Attacco E27 per sorgenti LED max 25W

- _ *Modern looking table lamp suitable for indoor spaces and outdoor as well like gardens, terraces and balconies*
- _ *RAL 7024 Anthracite powder-coated steel body and white UV protected PE diffuser.*
- _ *2m H05RN-F 2X1,0 mm² power cord with Schuko terminal plug (16A 250V).*
- _ *E27 base for LED light sources max 25W*



W	BASE		VARIANTE	CODICE	EAN	
-	E27	-	-	GARDA	8031453031893	1



GARDA

GARDA FLOOR

BTL CATEGORIA SCONTO 24

Lampada da terra per esterni / Outdoor floor lamp

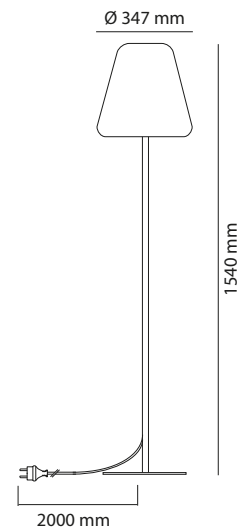

- _ Lampada da terra dall'aspetto moderno adatta sia ad usi all'interno che aree esterne come terrazzi, balconi e giardini.
- _ Corpo realizzato in acciaio verniciato a polvere di colore antracite RAL 7024 e diffusore in polietilene con protezione UV di colore bianco.
- _ Cavo di alimentazione da 2m H05RN-F 2X1,0 mm² dotato di spina Schuko (16A 250V).
- _ Attacco E27 per sorgenti LED max 25W

- _ *Modern looking floor lamp suitable for indoor spaces and outdoor as well like gardens, terraces and balconies*
- _ *RAL 7024 Anthracite powder-coated steel body and white UV protected PE diffuser.*
- _ *2m H05RN-F 2X1,0 mm² power cord with Schuko terminal plug (16A 250V).*
- _ *E27 base for LED light sources max 25W*



W	BASE		VARIANTE	CODICE	EAN	
-	E27	-	-	GARDAL	8031453031909	1



GARDA L





SHOT
BOT LIGHTING

TECNICO / LAMPADE SOLARI
TECHNICAL / SOLAR LAMPS



Lampione solare / Solar street light



Lampione solare professionale ad alta potenza e lunga durata. Adatto a molteplici applicazioni in ambito residenziale (viali, parcheggi, giardini), anche in sostituzione ai lampioni pre-esistenti. Grazie ai 4 settori indipendenti è possibile personalizzare l'area illuminata e regolare la potenza assorbita dall'apparecchio.

Professional high-power solar streetlight with long lifespan. Suitable for multiple applications in residential areas (driveways, parking lots, gardens), also as a replacement for pre-existing streetlights. Thanks to the 4 independent sectors, it is possible to customize the illuminated area and adjust the device's power consumption.

- Testa palo (Ø50-60 mm) con sensore crepuscolare e rilevatore di presenza PIR
- Facile installazione: non richiede collegamenti alla rete elettrica
- Batteria alta qualità LiFePO4 32700, 6,4V, 6000mAh, 38.4Wh
- Pannello solare 12Wp
- Tempo di ricarica: 6 ore
- Materiale ABS + PC anti UV , autoestinguente
- 4 settori attivabili singolarmente
- 2 modalità di funzionamento selezionabili e customizzabili tramite il telecomando incluso
- CCT selezionabile

- Pole head (Ø50-60 mm) with dusk sensor and PIR motion detector
- Easy installation: mains connection not needed
- High-quality LiFePO4 32700 battery, 6.4V, 6000mAh, 38.4Wh
- 12Wp solar panel
- Charging time: 6 hours
- Self-extinguishing ABS + PC anti UV material
- 4 sectors that can be activated individually
- 2 selectable and customizable operating modes via the included remote control
- Selectable CCT



W	K	LUMEN APPARECCHIO lm		VARIANTE	CODICE	EAN	
30	<input checked="" type="checkbox"/> 3000 <input type="checkbox"/> 4000 <input type="checkbox"/> 6500	4800	140°	-	KALAP4800NK	8031453033422	1/3

Batteria LiFePO4 32700 2 celle 6,4V 6000mAh per KALAP4800NK e YUMA4800NK

B222064060A

8031453033620

1

**KALAP****FUNZIONAMENTO**

Il proiettore ha due modalità di funzionamento, personalizzabili con il telecomando.

MODALITÀ SENSORE: l'apparecchio si accende automaticamente al tramonto al 10% di emissione luminosa. Quando viene rilevato movimento nel raggio di rilevamento dei sensori l'emissione luminosa passa al 100%, per poi tornare al 10% se per 20 secondi non viene rilevato alcun movimento. L'apparecchio si spegnerà al sorgere del sole o quando la batteria sarà completamente scarica.

MODALITÀ LUCE COSTANTE: l'apparecchio si accenderà al tramonto secondo le impostazioni di default: 60% di emissione luminosa costante per 3 ore. Dopo le 3 ore l'apparecchio passerà in MODALITÀ SENSORE. È possibile personalizzare i valori di emissione luminosa e durata del funzionamento in MODALITÀ LUCE COSTANTE tramite il telecomando.

OPERATION

The projector has two operating modes, customizable with the remote control.

SENSOR MODE: The device automatically turns on at sunset at 10% brightness. When motion is detected within the sensor's detection range, the brightness increases to 100%, then returns to 10% if no motion is detected for 20 seconds. The device will turn off at sunrise or when the battery is completely discharged.

CONSTANT LIGHT MODE: The device will turn on at sunset according to the default settings: 60% constant brightness for 3 hours. After 3 hours, the device will switch to SENSOR MODE. It is possible to customize the brightness level and operating duration in CONSTANT LIGHT MODE using the remote control.

Proiettore solare con pannello separato / Solar floodlight with separate panel

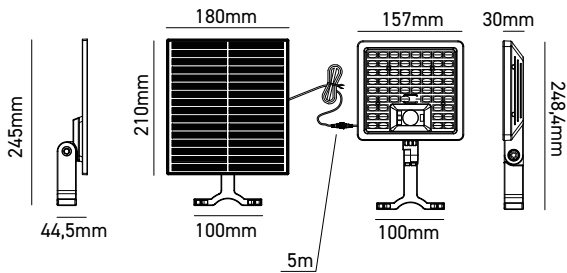

Il proiettore solare perfetto per illuminare spazi esterni senza bisogno di corrente elettrica. Con pannello separato, sensore crepuscolare e telecomando, garantisce praticità e versatilità per ogni impiego.

- Proiettore con sensore crepuscolare e rilevatore di presenza PIR
- Facile installazione: non richiede collegamenti alla rete elettrica
- Batteria alta qualità Li-ION 18650, 3.7V, 3600mAh, 13.32Wh
- Il proiettore può essere separato dal pannello ed utilizzato in modalità standalone
- Pannello solare 4,7Wp
- Tempo di ricarica: 4 ore
- Fascio asimmetrico 120° x 60° ampia area di illuminazione
- Materiale ABS + PC anti UV, autoestinguento
- Cavo di connessione di 5m con connettore IP67
- 2 modalità di funzionamento selezionabili e customizzabili tramite il telecomando incluso
- CCT selezionabile

FUNZIONAMENTO

Il proiettore ha due modalità di funzionamento, personalizzabili con il telecomando.

MODALITÀ SENSORE: il proiettore si accende automaticamente di notte, al 100% dell'emissione quando viene rilevato un movimento nell'intervallo <8-10m, quindi passa al 5% di emissione luminosa 20 secondi dopo aver rilevato l'ultimo movimento.

MODALITÀ LUCE COSTANTE: il proiettore si accende automaticamente di notte e rimane acceso per il tempo e l'emissione luminosa selezionati (3h-5h-8h-12h / 20%-40%-60%)

OPERATION

The projector features two operating modes, customizable via the remote control.

SENSOR MODE: The projector automatically turns on at night, emitting 100% brightness when motion is detected within a range of <8-10m, then switches to 5% brightness 20 seconds after the last motion is detected.

CONSTANT LIGHT MODE: The projector automatically turns on at night and remains on for the selected duration and brightness level (3h-5h-8h-12h / 20%-40%-60%)

The perfect solar projector for lighting outdoor spaces without the need for electricity. With a separate panel, twilight sensor, and remote control, it ensures practicality and versatility for any use.

- Floodlight with dusk sensor and PIR presence detector
- Easy installation: mains connection not needed
- High quality Li-ION 18650 battery, 3.7V, 3600mAh, 13.32Wh
- Floodlight can be separated from the solar panel for standalone use
- 4,7Wp solar panel
- Charging time: 4 hours
- Wide illumination area, 120° x 60° asymmetric beam angle
- Self-extinguishing ABS + PC anti UV material
- IP67 connector, 5m cable
- 2 selectable and customizable operating modes via the included remote controller
- Selectable CCT



W	K	LUMEN APPARECCHIO lm		VARIANTE	CODICE	EAN	
10	<input checked="" type="checkbox"/> 3000 <input type="checkbox"/> 4000 <input type="checkbox"/> 6500	1500	60X120°	-	YUMA1500NK	8031453032685	1/16

Batteria Li-ION 18650 2 celle 3,7V 3600mAh per YUMA1500NK

B112037036A

8031453033552

1

YUMA2800NK

NEW

BTL CATEGORIA SCONTO 24

Proiettore solare con pannello separato / Solar floodlight with separate panel

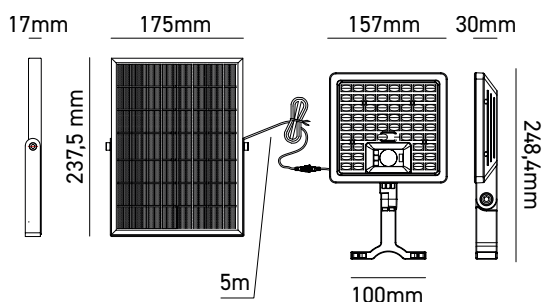

Il proiettore solare perfetto per illuminare spazi esterni senza bisogno di corrente elettrica. Con pannello separato, sensore crepuscolare e telecomando, garantisce praticità e versatilità per ogni impiego

FUNZIONAMENTO

Il proiettore ha due modalità di funzionamento, personalizzabili con il telecomando.

MODALITÀ SENSORE: il proiettore si accende automaticamente di notte, al 100% dell'emissione quando viene rilevato un movimento nell'intervallo <8-10m, quindi passa al 5% di emissione luminosa 20 secondi dopo aver rilevato l'ultimo movimento.

MODALITÀ LUCE COSTANTE: il proiettore si accende automaticamente di notte e rimane acceso per il tempo e l'emissione luminosa selezionati (3h-5h-8h-12h / 20%-40%-60%)

OPERATION

The projector features two operating modes, customizable via the remote control.

SENSOR MODE: The projector automatically turns on at night, emitting 100% brightness when motion is detected within a range of <8-10m, then switches to 5% brightness 20 seconds after the last motion is detected.

CONSTANT LIGHT MODE: The projector automatically turns on at night and remains on for the selected duration and brightness level (3h-5h-8h-12h / 20%-40%-60%)

The perfect solar projector for lighting outdoor spaces without the need for electricity. With a separate panel, twilight sensor, and remote control, it ensures practicality and versatility for any use

- _ Proiettore con sensore crepuscolare e rilevatore di presenza PIR
- _ Facile installazione: non richiede collegamenti alla rete elettrica
- _ Batteria alta qualità Li-ION 18650, 7.4V, 3600mAh, 26.64Wh
- _ Il proiettore può essere separato dal pannello ed utilizzato in modalità standalone
- _ Pannello solare 7,5Wp
- _ Tempo di ricarica: 5 ore
- _ Fascio asimmetrico 120° x 60° ampia area di illuminazione
- _ Materiale ABS + PC anti UV, autoestinguente
- _ Cavo di connessione di 5m con connettore IP67
- _ 2 modalità di funzionamento selezionabili e customizzabili tramite il telecomando incluso
- _ CCT selezionabile

- _ Floodlight with dusk sensor and PIR presence detector
- _ Easy installation: mains connection not needed
- _ High quality Li-ION 18650 battery, 7.4V, 3600mAh, 26.64Wh
- _ Floodlight can be separated from the solar panel for standalone use
- _ 7,5Wp solar panel
- _ Charging time: 5 hours
- _ Wide illumination area, 120° x 60° asymmetric beam angle
- _ Self-extinguishing ABS + PC anti UV material
- _ IP67 connector, 5m cable
- _ 2 selectable and customizable operating modes via the included remote controller
- _ Selectable CCT



W	K	LUMEN APPARECCHIO lm		VARIANTE	CODICE	EAN	
20	<input checked="" type="checkbox"/> 3000 <input type="checkbox"/> 4000 <input type="checkbox"/> 6500	2800	60X120°	-	YUMA2800NK	8031453032692	1/16

Batteria Li-ION 18650 4 celle 7,4V 3600mAh per YUMA2800NK

B114074036A

8031453033590

1

YUMA4800NK NEW

BTL CATEGORIA SCONTO 24

Proiettore solare con pannello separato / Solar floodlight with separate panel

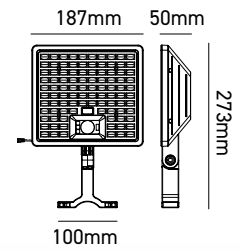
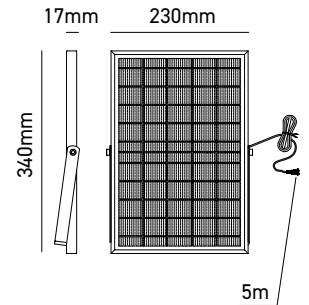

Il proiettore solare perfetto per illuminare spazi esterni senza bisogno di corrente elettrica. Con pannello separato, sensore crepuscolare e telecomando, garantisce praticità e versatilità per ogni impiego

- _ Proiettore con sensore crepuscolare e rilevatore di presenza PIR
- _ Facile installazione: non richiede collegamenti alla rete elettrica
- _ Batteria alta qualità LiFePO4 32700, 6.4V, 6000mAh, 38.4Wh
- _ Il proiettore può essere separato dal pannello ed utilizzato in modalità standalone
- _ Pannello solare 12Wp
- _ Tempo di ricarica: 6 ore
- _ Fascio asimmetrico 120° x 60° ampia area di illuminazione
- _ Materiale ABS + PC anti UV, autoestinguento
- _ Cavo di connessione di 5m con connettore IP67
- _ 2 modalità di funzionamento selezionabili e customizzabili tramite il telecomando incluso
- _ CCT selezionabile

The perfect solar projector for lighting outdoor spaces without the need for electricity. With a separate panel, twilight sensor, and remote control, it ensures practicality and versatility for any use

- _ Floodlight with dusk sensor and PIR presence detector
- _ Easy installation: mains connection not needed
- _ High quality LiFePO4 32700 battery, 6.4V, 6000mAh, 38.4Wh
- _ Floodlight can be separated from the solar panel for standalone use
- _ 12Wp solar panel
- _ Charging time: 6 hours
- _ Wide illumination area, 120° x 60° asymmetric beam angle
- _ Self-extinguishing ABS + PC anti UV material
- _ IP67 connector, 5m cable
- _ 2 selectable and customizable operating modes via the included remote controller
- _ Selectable CCT



W	K	LUMEN APPARECCHIO lm		VARIANTE	CODICE	EAN	
30	<input type="checkbox"/> 3000 <input type="checkbox"/> 4000 <input type="checkbox"/> 6500	4800	60X120°	-	YUMA4800NK	8031453032708	1/6

Batteria LiFePO4 32700 2 celle 6,4V 6000mAh per KALAP4800NK e YUMA4800NK

B222064060A

8031453033620

1



FUNZIONAMENTO

Il proiettore ha due modalità di funzionamento, personalizzabili con il telecomando.

MODALITÀ SENSORE: il proiettore si accende automaticamente di notte, al 100% dell'emissione quando viene rilevato un movimento nell'intervallo <8-10m, quindi passa al 5% di emissione luminosa 20 secondi dopo aver rilevato l'ultimo movimento.

MODALITÀ LUCE COSTANTE: il proiettore si accende automaticamente di notte e rimane acceso per il tempo e l'emissione luminosa selezionati (3h-5h-8h-12h / 20%-40%-60%)

OPERATION

The projector features two operating modes, customizable via the remote control.

SENSOR MODE: The projector automatically turns on at night, emitting 100% brightness when motion is detected within a range of <8-10m, then switches to 5% brightness 20 seconds after the last motion is detected.

CONSTANT LIGHT MODE: The projector automatically turns on at night and remains on for the selected duration and brightness level (3h-5h-8h-12h / 20%-40%-60%)

YUMA11NK

BTL CATEGORIA SCONTO 24

Proiettore solare stradale / Street solar floodlight

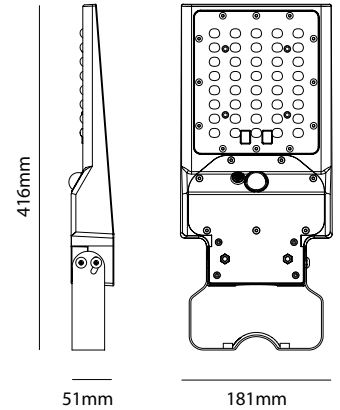

- _ Proiettore con sensore crepuscolare e rilevatore di presenza PIR
- _ Facile Installazione: non richiede collegamento alla rete elettrica.
- _ Batteria alta qualità LiFePO4 32700, 3.2V, 6000mAh, 19.2Wh
- _ Pannello solare 7,4Wp
- _ Tempo di ricarica: 4 ore
- _ Staffa di fissaggio inclusa
- _ Materiale ABS + PC anti UV , autoestinguento
- _ CCT selezionabile
- _ Telecomando incluso

- _ Floodlight with dusk sensor and PIR presence detector
- _ Easy to install: does not require connection to mains energy.
- _ High quality LiFePO4 32700 battery, 3.2V, 6000mAh, 19.2Wh
- _ 7,4Wp solar panel
- _ Charging time: 4 hours
- _ Fixing bracket included
- _ Material ABS + PC anti UV, self-extinguishing
- _ Selectable CCT
- _ Remote controller included



W	K	LUMEN APPARECCHIO lm		VARIANTE	CODICE	EAN	
---	---	----------------------	--	----------	--------	-----	--

10	<input checked="" type="checkbox"/> 3000 <input type="checkbox"/> 4000 <input type="checkbox"/> 6500	1500	70x140°	-	YUMA11NK	8031453031916	1/6
----	--	------	---------	---	-----------------	---------------	-----

Batteria LiFePO4 32700 1 cella 3.2V 6000mAh per YUMA11NK				B221032060A	8031453033613	1
--	--	--	--	--------------------	---------------	---



FUNZIONAMENTO

Premere il pulsante ROSSO sull'apparecchio, si accenderà automaticamente in Modalità 1. Premere nuovamente il pulsante per spostarsi in Modalità 2. Premere una terza volta per spegnere il proiettore ed entrare in Modalità OFF. Il telecomando si può utilizzare fintanto che il proiettore non verrà impostato in Modalità OFF utilizzando il tasto presente sullo stesso. Se l'apparecchio viene settato in Modalità OFF dal telecomando, non ne verrà precluso il funzionamento. La lampada ha funzione memoria se usata tramite telecomando, non ha funzione memoria se utilizzata tramite il pulsante.

SELEZIONE CCT: per selezionare il colore desiderato, una volta acceso il proiettore:

- tenere premuto il tasto sull'apparecchio per 3 secondi (ordine colori: 6500K, 4000K, 3000K)
- utilizzare gli appositi tasti sul telecomando (Warm: 3000K, Neutral: 4000K, Cool: 6500K)

MODALITÀ 1: alla prima pressione del pulsante il proiettore lampeggia una volta per segnalare l'entrata in funzione in Modalità 1. Il proiettore si accende al 100% dell'emissione luminosa quando viene rilevato movimento nel raggio d'azione del sensore (120°-8/10m) per poi passare al 4% dell'emissione luminosa 20 secondi dopo l'ultimo movimento rilevato. Il funzionamento avverrà fino all'alba o all'esaurimento della batteria.

MODALITÀ 2: alla seconda pressione del pulsante il proiettore lampeggia due volte per segnalare l'entrata in funzione in Modalità 2. Il proiettore si accende al 50% dell'emissione luminosa per 6 ore. Passate le 6 ore l'apparecchio passerà automaticamente in Modalità 1 e la manterrà fino all'alba o ad esaurimento della batteria.

OPERATION

Press the RED button on the appliance, it will turn on automatically in Mode 1. Press the button again to move to Mode 2. Press a third time to turn off the projector and enter OFF Mode. The remote control can be used as long as the projector will not be set to OFF mode by using the button on the projector. If the appliance is set to OFF mode by the remote control, it will not be prevented from operating. The lamp has memory function if used by remote control, it has no memory function if used by the button.

CCT SELECTION: to select the color you want, once the projector is turned on:

- press and hold the button on the appliance for 3 seconds (colors order: 6500K, 4000K, 3000K)*
- use the appropriate buttons on the remote control (Warm: 3000K, Neutral: 4000K, Cool: 6500K)*

MODE 1: when the button is pressed for the first time, the projector flashes once to signal that it has entered Mode 1. The projector turns on at 100% of the light output when motion is detected within the range of the sensor (120°-8/10m) and then turns on at 4% of the light output 20 seconds after the last motion detected. Operation will occur until the battery is fully discharged or until dawn.

MODE 2: on the second press of the button, the projector flashes twice to signal that it has entered Mode 2 operation. The projector turns on at 50% of the light output for 6 hours. After 6 hours, the appliance will automatically switch to Mode 1 and maintain it until dawn or when the battery runs out.

YUMA15NK

BTL CATEGORIA SCONTO 24

Proiettore solare stradale / Street solar floodlight

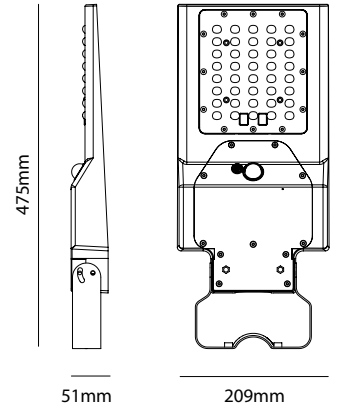

- _ Proiettore con sensore crepuscolare e rilevatore di presenza PIR
- _ Facile Installazione: non richiede collegamento alla rete elettrica.
- _ Batteria alta qualità LiFePO4 32700, 6.4V, 6000mAh, 38.4Wh
- _ Pannello solare 10Wp
- _ Tempo di ricarica: 6 ore
- _ Staffa di fissaggio inclusa
- _ Materiale ABS + PC anti UV , autoestinguento
- _ CCT selezionabile
- _ Telecomando incluso

- _ Floodlight with dusk sensor and PIR presence detector
- _ Easy to install: does not require connection to mains energy.
- _ High quality 32700 LiFePO4 battery, 6.4V, 6000mAh, 38.4Wh
- _ 10Wp solar panel
- _ Charging time: 6 hours
- _ Fixing bracket included
- _ Material ABS + PC anti UV, self-extinguishing
- _ Selectable CCT
- _ Remote controller included



W	K	LUMEN APPARECCHIO lm		VARIANTE	CODICE	EAN	
---	---	----------------------	--	----------	--------	-----	--

15	<input type="checkbox"/> 3000 <input checked="" type="checkbox"/> 4000 <input type="checkbox"/> 6500	2500	70x140°	-	YUMA15NK	8031453031923	1/6
----	--	------	---------	---	-----------------	---------------	-----

Batteria LiFePO4 32700 2 celle 6,4V 6000mAh per YUMA15NK	B222064060B	8031453033637	1
--	--------------------	---------------	---



FUNZIONAMENTO

Premere il pulsante ROSSO sull'apparecchio, si accenderà automaticamente in Modalità 1. Premere nuovamente il pulsante per spostarsi in Modalità 2. Premere una terza volta per spegnere il proiettore ed entrare in Modalità OFF. Il telecomando si può utilizzare fintanto che il proiettore non verrà impostato in Modalità OFF utilizzando il tasto presente sullo stesso. Se l'apparecchio viene settato in Modalità OFF dal telecomando, non ne verrà precluso il funzionamento. La lampada ha funzione memoria se usata tramite telecomando, non ha funzione memoria se utilizzata tramite il pulsante.

SELEZIONE CCT: per selezionare il colore desiderato, una volta acceso il proiettore:

- tenere premuto il tasto sull'apparecchio per 3 secondi (ordine colori: 6500K, 4000K, 3000K)
- utilizzare gli appositi tasti sul telecomando (Warm: 3000K, Neutral: 4000K, Cool: 6500K)

MODALITÀ 1: alla prima pressione del pulsante il proiettore lampeggia una volta per segnalare l'entrata in funzione in Modalità 1. Il proiettore si accende al 100% dell'emissione luminosa quando viene rilevato movimento nel raggio d'azione del sensore (120°-8/10m) per poi passare al 4% dell'emissione luminosa 20 secondi dopo l'ultimo movimento rilevato. Il funzionamento avverrà fino all'alba o all'esaurimento della batteria.

MODALITÀ 2: alla seconda pressione del pulsante il proiettore lampeggia due volte per segnalare l'entrata in funzione in Modalità 2. Il proiettore si accende al 50% dell'emissione luminosa per 6 ore. Passate le 6 ore l'apparecchio passerà automaticamente in Modalità 1 e la manterrà fino all'alba o ad esaurimento della batteria.

OPERATION

Press the RED button on the appliance, it will turn on automatically in Mode 1. Press the button again to move to Mode 2. Press a third time to turn off the projector and enter OFF Mode. The remote control can be used as long as the projector will not be set to OFF mode by using the button on the projector. If the appliance is set to OFF mode by the remote control, it will not be prevented from operating. The lamp has memory function if used by remote control, it has no memory function if used by the button.

CCT SELECTION: to select the color you want, once the projector is turned on:

- press and hold the button on the appliance for 3 seconds (colors order: 6500K, 4000K, 3000K)
- use the appropriate buttons on the remote control (Warm: 3000K, Neutral: 4000K, Cool: 6500K)

MODE 1: when the button is pressed for the first time, the projector flashes once to signal that it has entered Mode 1. The projector turns on at 100% of the light output when motion is detected within the range of the sensor (120°-8/10m) and then turns on at 4% of the light output 20 seconds after the last motion detected. Operation will occur until the battery is fully discharged or until dawn.

MODE 2: on the second press of the button, the projector flashes twice to signal that it has entered Mode 2 operation. The projector turns on at 50% of the light output for 6 hours. After 6 hours, the appliance will automatically switch to Mode 1 and maintain it until dawn or when the battery runs out.

YUMA40NK

BTL CATEGORIA SCONTO 24

Proiettore solare stradale / Street solar floodlight

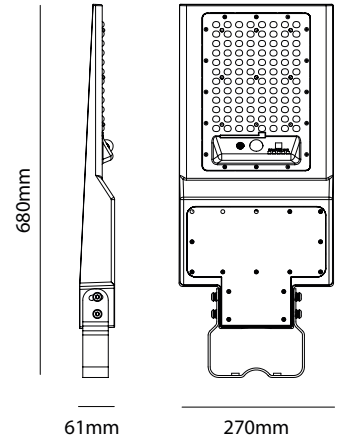

- _ Proiettore con sensore crepuscolare e rilevatore di presenza PIR
- _ Facile Installazione: non richiede collegamento alla rete elettrica.
- _ Batteria alta qualità LiFePO4 32700, 9.6V, 12000mAh, 115.2Wh
- _ Pannello solare 21Wp
- _ Tempo di ricarica: 8 ore
- _ Materiale ABS + PC anti UV , autoestinguento
- _ Dotato di ottiche per una distribuzione ottimizzata del flusso luminoso.
- _ CCT selezionabile
- _ Telecomando incluso

- _ Floodlight with dusk sensor and PIR presence detector
- _ Easy to install: does not require connection to mains energy.
- _ High quality LiFePO4 32700 battery, 9.6V, 12000mAh, 115.2Wh
- _ 21Wp solar panel
- _ Charging time: 8 hours
- _ High resistance black colour ABS body and high PC diffuser quality, self-extinguish
- _ Equipped with optics for optimized distribution of the luminous flux.
- _ Selectable CCT
- _ Remote controller included



W	K	LUMEN APPARECCHIO lm		VARIANTE	CODICE	EAN	
40	<input checked="" type="checkbox"/> 3000 <input type="checkbox"/> 4000 <input type="checkbox"/> 6500	6200	70x140°	-	YUMA40NK	8031453031930	1/3
Batteria LiFePO4 32700 6 celle 9,6V 12000mAh per YUMA40NK					B226096012A	8031453033651	1



FUNZIONAMENTO

Premere il pulsante ROSSO sull'apparecchio, si accenderà automaticamente in Modalità 1. Premere nuovamente il pulsante per spostarsi in Modalità 2. Premere una terza volta per spegnere il proiettore ed entrare in Modalità OFF. Il telecomando si può utilizzare fintato che il proiettore non verrà impostato in Modalità OFF utilizzando il tasto presente sullo stesso. Se l'apparecchio viene settato in Modalità OFF dal telecomando, non ne verrà precluso il funzionamento. La lampada ha funzione memoria se usata tramite telecomando, non ha funzione memoria se utilizzata tramite il pulsante.

SELEZIONE CCT: per selezionare il colore desiderato, una volta acceso il proiettore:

- tenere premuto il tasto sull'apparecchio per 3 secondi (ordine colori: 6500K, 4000K, 3000K)
- utilizzare gli appositi tasti sul telecomando (Warm: 3000K, Neutral: 4000K, Cool: 6500K)

MODALITÀ 1: alla prima pressione del pulsante il proiettore lampeggia una volta per segnalare l'entrata in funzione in Modalità 1. Il proiettore si accende al 100% dell'emissione luminosa quando viene rilevato movimento nel raggio d'azione del sensore (120°-8/10m) per poi passare al 4% dell'emissione luminosa 20 secondi dopo l'ultimo movimento rilevato. Il funzionamento avverrà fino all'alba o all'esaurimento della batteria.

MODALITÀ 2: alla seconda pressione del pulsante il proiettore lampeggia due volte per segnalare l'entrata in funzione in Modalità 2. Il proiettore si accende al 50% dell'emissione luminosa per 12 ore che manterrà fino all'alba o ad esaurimento della batteria.

OPERATION

Press the RED button on the appliance, it will turn on automatically in Mode 1. Press the button again to move to Mode 2. Press a third time to turn off the projector and enter OFF Mode. The remote control can be used as long as the projector will not be set to OFF mode by using the button on the projector. If the appliance is set to OFF mode by the remote control, it will not be prevented from operating. The lamp has memory function if used by remote control, it has no memory function if used by the button.

CCT SELECTION: to select the color you want, once the projector is turned on:

- press and hold the button on the appliance for 3 seconds (colors order: 6500K, 4000K, 3000K)
- use the appropriate buttons on the remote control (Warm: 3000K, Neutral: 4000K, Cool: 6500K)

MODE 1: when the button is pressed for the first time, the projector flashes once to signal that it has entered Mode 1. The projector turns on at 100% of the light output when motion is detected within the range of the sensor (120°-8/10m) and then turns on at 4% of the light output 20 seconds after the last motion detected. Operation will occur until the battery is fully discharged or until dawn.

MODE 2: on the second press of the button, the projector flashes twice to signal that it has entered Mode 2 operation. The projector turns on at 50% of the light output for 12 hours that will maintain until dawn or when the battery runs out.



SHOT
BOT LIGHTING

RESIDENZIALE / LAMPADE SOLARI
RESIDENTIAL / SOLAR LAMPS

INCLINE2N NEW

BTL CATEGORIA SCONTO 24

Proiettore solare / Solar floodlight

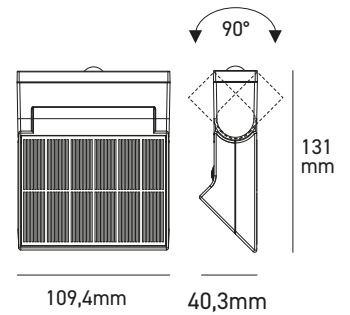

Per il funzionamento
vedi pagina

For the product's operation
see page

433





Questa applique solare con luce orientabile unisce praticità e sostenibilità, illuminando i tuoi spazi esterni solo quando serve grazie al sensore di movimento integrato. In aggiunta è possibile attivare la luce di cortesia durante le ore notturne.

- _ Wall light con sensore crepuscolare e rilevatore di presenza PIR
- _ Facile installazione: non richiede collegamenti alla rete elettrica
- _ Batteria Li-ION 18650, 3.7V, 1200mAh, 4.44Wh
- _ Pannello solare 1Wp
- _ Tempo di ricarica 5 ore
- _ Testa orientabile di 90°
- _ Materiale ABS + PC anti UV , autoestinguente
- _ 2 modalità di funzionamento
- _ Luce di cortesia 3000K

This solar wall light with adjustable illumination combines practicality and sustainability, lighting up your outdoor spaces only when needed thanks to the integrated motion sensor. Additionally, it is possible to activate courtesy lighting during nighttime hours.

- _ Wall light with dusk sensor and PIR motion detector
- _ Easy installation: mains connection not needed
- _ High quality Li-ION 18650 battery, 3.7V, 1200mAh, 4.44Wh
- _ 1Wp solar panel
- _ 5 hours charging time
- _ 90° adjustable head
- _ Self-extinguishing ABS + PC anti UV material
- _ 2 operating modes
- _ 3000K courtesy light



W	K	LUMEN APPARECCHIO lm		VARIANTE	CODICE	EAN	
2	4000	300	60x120°	-	INCLINE2N	8031453033040	1/24
Batteria Li-ION 18650 1 cella 3,7V 1200mAh per INCLINE2N					B111037012B	8031453033477	1

INCLINE4N NEW

BTL CATEGORIA SCONTO 24

Proiettore solare / Solar floodlight

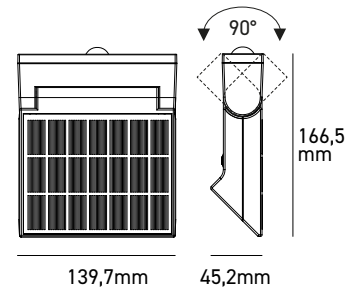

Per il funzionamento
vedi pagina

For the product's operation
see page

433





Questa applique solare con luce orientabile unisce praticità e sostenibilità, illuminando i tuoi spazi esterni solo quando serve grazie al sensore di movimento integrato. In aggiunta è possibile attivare la luce di cortesia durante le ore notturne.

- _ Wall light con sensore crepuscolare e rilevatore di presenza PIR
- _ Facile installazione: non richiede collegamenti alla rete elettrica
- _ Batteria Li-ION 18650, 3.7V, 2000mAh, 7.4Wh
- _ Pannello solare 2,2Wp
- _ Tempo di ricarica 5 ore
- _ Testa orientabile di 90°
- _ Materiale ABS + PC anti UV , autoestinguente
- _ 2 modalità di funzionamento
- _ Luce di cortesia 3000K

This solar wall light with adjustable illumination combines practicality and sustainability, lighting up your outdoor spaces only when needed thanks to the integrated motion sensor. Additionally, it is possible to activate courtesy lighting during nighttime hours.

- _ Wall light with dusk sensor and PIR motion detector
- _ Easy installation: mains connection not needed
- _ High quality Li-ION 18650 battery, 3.7V, 2000mAh, 7.4Wh
- _ 2,2Wp solar panel
- _ 5 hours charging time
- _ 90° adjustable head
- _ Self-extinguishing ABS + PC anti UV material
- _ 2 operating modes
- _ 3000K courtesy light



W	K	LUMEN APPARECCHIO lm		VARIANTE	CODICE	EAN	
4	<input type="checkbox"/> 4000	600	60x120°	-	INCLINE4N	8031453033057	1/24
Batteria Li-ION 18650 1 cella 3.7V 2000mAh per INCLINE4N					B111037020B	8031453033491	1

INCLINE8N NEW

BTL CATEGORIA SCONTO 24

Proiettore solare / Solar floodlight

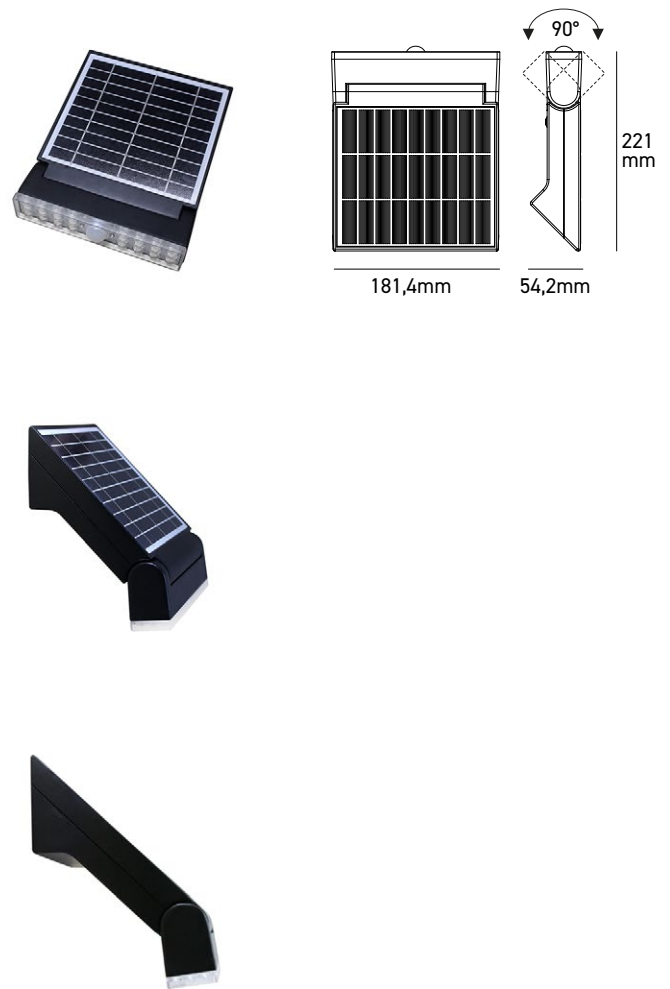

Questa applique solare con luce orientabile unisce praticità e sostenibilità, illuminando i tuoi spazi esterni solo quando serve grazie al sensore di movimento integrato. In aggiunta è possibile attivare la luce di cortesia durante le ore notturne.

This solar wall light with adjustable illumination combines practicality and sustainability, lighting up your outdoor spaces only when needed thanks to the integrated motion sensor. Additionally, it is possible to activate courtesy lighting during nighttime hours.

- _ Wall light con sensore crepuscolare e rilevatore di presenza PIR
- _ Facile installazione: non richiede collegamenti alla rete elettrica
- _ Batteria Li-ION 18650, 3.7V, 4000mAh, 14.8Wh
- _ Pannello solare 4,2Wp
- _ Tempo di ricarica 5 ore
- _ Testa orientabile di 90°
- _ Materiale ABS + PC anti UV , autoestinguente
- _ 2 modalità di funzionamento
- _ Luce di cortesia 3000K

- _ Wall light with dusk sensor and PIR motion detector
- _ Easy installation: mains connection not needed
- _ High quality Li-ION 18650 battery, 3.7V, 4000mAh, 14.8Wh
- _ 4,2Wp solar panel
- _ 5 hours charging time
- _ 90° adjustable head
- _ Self-extinguishing ABS + PC anti UV material
- _ 2 operating modes
- _ 3000K courtesy light



W	K	LUMEN APPARECCHIO lm		VARIANTE	CODICE	EAN	
8	<input type="checkbox"/> 4000	1200	60x120°	-	INCLINE8N	8031453033064	1/12
Batteria Li-ION 18650 2 celle 3,7V 4000mAh per INCLINE8N					B112037040A	8031453033569	1

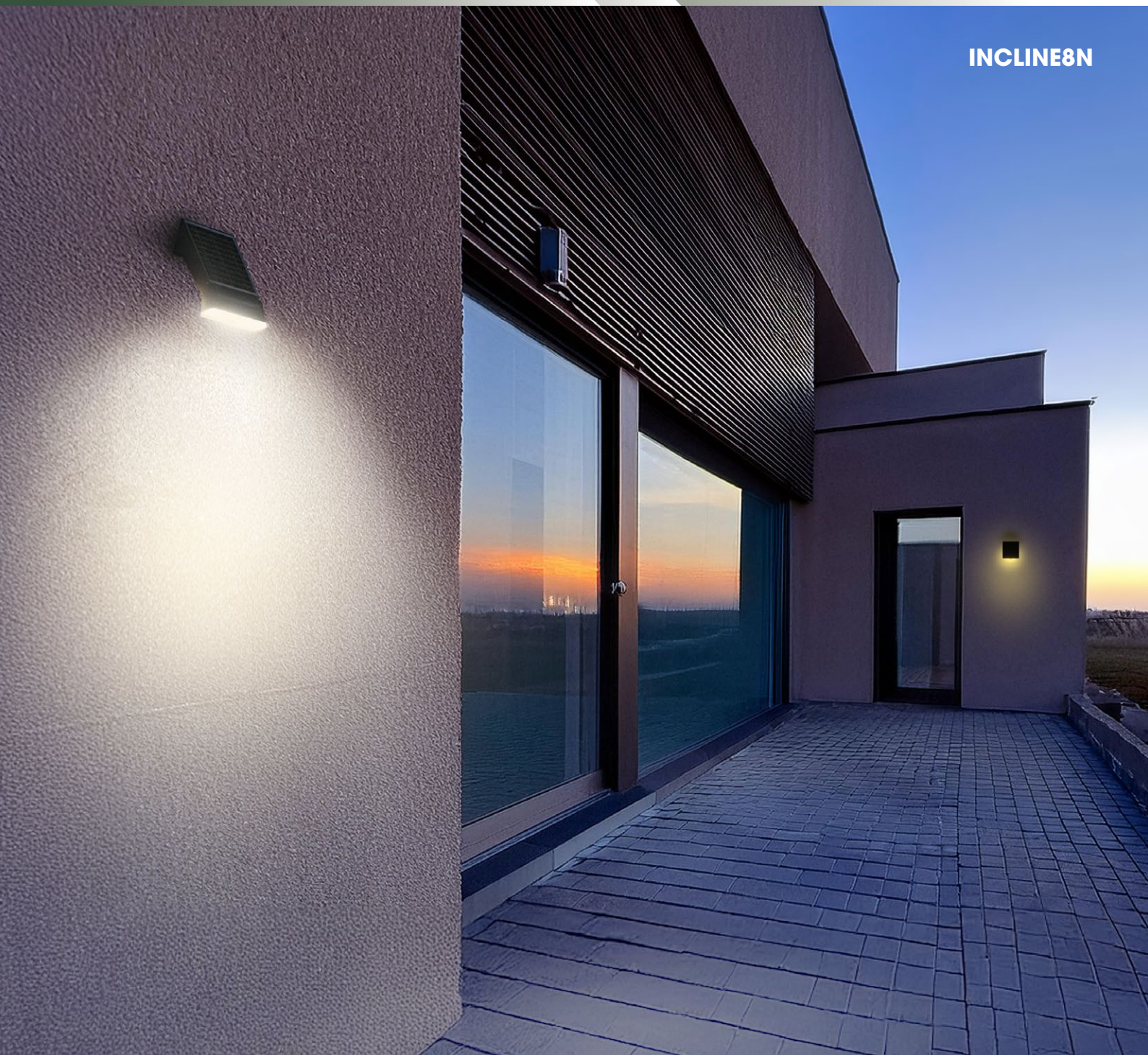

FUNZIONAMENTO APPLIQUE SOLARI INCLINE2/4/8

L'apparecchio ha due modalità di funzionamento, selezionabili tramite il pulsante sul retro. La luce di cortesia posta sul retro dell'apparecchio emette una luce di colore 3000K, la luce principale posta sulla porzione frontale emette una luce di colore 4000K.

MODALITÀ 1: la luce principale e la luce di cortesia si accendono al 100% di emissione luminosa quando viene rilevato un movimento e rimangono accese per 20 secondi dopo l'ultimo movimento rilevato. Passati i 20 secondi dall'ultimo rilevamento, rimane accesa al 100% di emissione luminosa solo la luce di cortesia.

MODALITÀ 2: la luce principale si accende al 100% di emissione luminosa quando viene rilevato un movimento e rimane accesa per 20 secondi dopo l'ultimo movimento rilevato. Passati i 20 secondi dall'ultimo rilevamento, l'apparecchio si spegne. In questa modalità la luce di cortesia rimane sempre spenta.

INCLINE2/4/8 SOLAR LAMP OPERATIONS

The device has two operating modes, selectable via the button on the back. The courtesy light located on the back of the device emits a 3000K light, while the main light on the front emits a 4000K light.

MODE 1: The main light and the courtesy light turn on at 100% brightness when motion is detected and remain on for 20 seconds after the last detected motion. After 20 seconds from the last motion detection, only the courtesy light remains on at 100% brightness.

MODE 2: The main light turns on at 100% brightness when motion is detected and remains on for 20 seconds after the last detected motion. After 20 seconds from the last motion detection, the device turns off. In this mode, the courtesy light always remains off.

YUMA2N

BTL CATEGORIA SCONTO 24

Proiettore solare / Solar floodlight



FUNZIONAMENTO

Quando la batteria è carica (>30%), la lampada si accende alla massima luminosità (240lm) quando il sensore rileva ad un distanza ≤6 m un movimento. Dopo 10 secondi senza rilevamento, automaticamente si posiziona al 20% con luce frontale e posteriore.

Quando la batteria è al di sotto del 30% di carica, la lampada si accende alla massima luminosità (240lm) quando il sensore rileva ad un distanza ≤6 m un movimento. Dopo 10 secondi senza rilevamento, automaticamente la lampada si spegne.

OPERATION

When the battery is charged (>30%), the light switches on at maximum brightness (240 lm) when the sensor detects a movement at a distance of ≤6 m. After 10 seconds with no movement detected, the front and rear brightness automatically reduces to 20%

When the battery has less than 30% charge, the light switches on at maximum brightness (240 lm) when the sensor detects a movement at a distance of ≤6 m. After 10 seconds with no movement detected, the light automatically switches off.

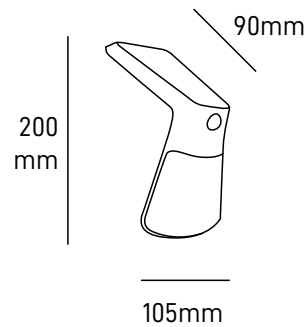

- _ Wall Light con sensore crepuscolare e rilevatore di presenza PIR
- _ Facile Installazione: non richiede collegamenti alla rete elettrica.
- _ Luce di cortesia indiretta sempre accesa di notte
- _ Batteria Li-ION 18650, 3.7V, 1200mAh, 8.4Wh
- _ Pannello solare 0,7W
- _ Tempo di ricarica: 6 ore
- _ Materiale ABS + PC anti UV , autoestinguente

- _ Wall light with PIR motion and dusk sensor
- _ Easy Installation: does not require connections to the electrical network.
- _ Indirect courtesy light always on at night
- _ Li-ION 18650 battery 3.7V, 1200mAh, 8.4Wh
- _ 0,7Wp solar panel
- _ Charging time: 6 hours
- _ Material ABS + PC anti UV, self-extinguishing



W	K	LUMEN APPARECCHIO lm		VARIANTE	CODICE	EAN	
2	4000	240	90°	-	YUMA2N	8031453020699	1/24

YUMA8NP

Proiettore e picchetto solare / Solar and stake light



FUNZIONAMENTO

Il picchetto ha quattro modalità di funzionamento, selezionabili con il telecomando.

MODALITÀ 1: quando viene rilevato movimento la luce si accende al 100% per 30 secondi.

MODALITÀ 2: quando non viene rilevato movimento la luce rimane accesa al 10%, al rilevamento la luce passa al 100% per 30 secondi.

MODALITÀ 3: la luce rimane accesa al 10%, il sensore di movimento rimane inattivo.

MODALITÀ SOS: quando viene rilevato movimento, la luce emette il segnale di SOS.

OPERATION

The floodlight has four working modes, selectable with the remote control.

MODE 1: when the person enters the detection area, the light will be 100% for 30sec.

MODE 2: no one enters the detection area, keep the light to 10%. When movement is detected, the light will be 100% for 30sec.

MODE 3: light stays 10%, the movement sensor will be deactivated.

MODE SOS: When the person enters the detection area, SOS signal flashing from the device.

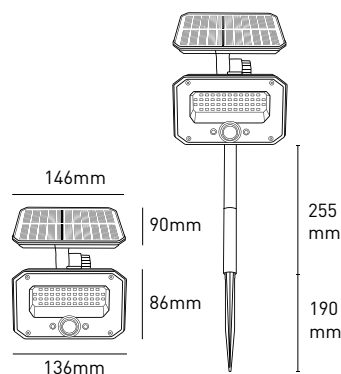

- _ Proiettore con sensore crepuscolare e rilevatore di presenza PIR
- _ Facile Installazione: non richiede collegamenti alla rete elettrica.
- _ 2 batterie Li-ION 18650, 3.7V, 2400mAh, 8,88Wh
- _ Pannello solare 1,5Wp
- _ Tempo di ricarica: 8 ore
- _ Il proiettore può essere utilizzato sia a parete che con picchetto a terra
- _ Materiale ABS + PC anti UV, autoestinguento
- _ Telecomando incluso
- _ 4 modalità di funzionamento selezionabili

- _ Floodlight with dusk sensor and PIR presence detector
- _ Easy Installation: does not require connections to the electrical network.
- _ 2x Li-ION 18650 battery, 3.7V, 2400mAh, 8,88Wh
- _ 1,5Wp solar panel
- _ Charging time: 8 hours
- _ The floodlight can be used both on the wall and with a ground spike
- _ Material ABS + PC anti UV, self-extinguishing
- _ Remote control included
- _ 4 selectable operating modes



W	K	LUMEN APPARECCHIO lm		VARIANTE	CODICE	EAN	
8	4000	850	60x120°	-	YUMA8NP	8031453028701	1/8

Batteria Li-ION 18650 1 cella 3.7V 2400mAh per YUMA8NP (necessari 2 pezzi)

B111037024Z

8031453033545

1

YUMA6NK

BTL CATEGORIA SCONTO 24

Proiettore solare / Solar floodlight



REGOLABILE / ADJUSTABLE

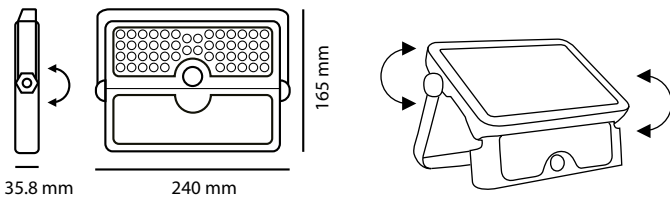

- Proiettore con sensore crepuscolare e rilevatore di presenza PIR
- Facile Installazione: non richiede collegamenti alla rete elettrica
- Batteria Li-HON 18650, 3.7V, 3000mAh, 11.1Wh
- Pannello solare 2,3Wp
- Tempo di ricarica: 6 ore
- Materiale ABS + PC anti UV , autoestinguente
- CCT selezionabile

FUNZIONAMENTO

- TASTO ON/OFF (1):** Premere una volta il tasto per accendere il proiettore. Premerlo nuovamente per cambiare il colore della luce. In questa modalità l'apparecchio rimarrà acceso al 30% fino all'esaurimento della batteria o al sorgere del sole. Tenerlo premuto per 3sec per spegnere l'apparecchio.
- TASTO SENSOR MODE (2):** In questa modalità il proiettore si accende al rilevamento del movimento con emissione luminosa del 100% se la luce ambientale rilevata tramite il pannello è al di sotto dei 40lux circa. Se non viene rilevato movimento per 30 secondi la luce si spegne.
- TASTO ALL NIGHT MODE (3):** Fino a quando la luminosità ambientale rilevata è inferiore a circa 40lux il pannello rimane acceso al 10% di emissione luminosa, fino alla scarica della batteria o al sorgere del sole.
- TASTO LOW LIGHT SENSOR MODE (4):** In questa modalità il proiettore si accende al rilevamento del movimento con il 100% di emissione. Se non viene rilevato movimento per 30 secondi, il proiettore passerà al 10% di emissione fino al movimento rilevato successivo.

OPERATION

- ON/OFF KEY (1):** Press the button once, to turn on the projector. Press it again to change the color of the light. In this mode, the appliance will remain on at 30% until the battery runs out or the sun rises. Press and hold more than 3 sec to turn off the appliance.
- SENSOR MODE KEY (2):** In this mode the projector will turn on, when motion is detected, at 100% light output. If the ambient light detected through the panel is below 40lux. If no motion is detected for 30 seconds, the light will turn off.
- ALL NIGHT MODE KEY (3):** As long as the ambient brightness detected is less than about 40lux, the panel remains on at 10% light output until the battery is discharged or the sun rises.
- LOW LIGHT SENSOR MODE KEY (4):** In this mode the projector will turn, when motion is detected, at 100% output. If no motion is detected for 30 seconds, the projector will switch to 10% output until the next motion detected.

- Floodlight with dusk sensor and PIR presence detector
- Easy to install: does not require connection to mains energy
- Li-HON 18650 battery 3.7V, 3000mAh, 11.1Wh
- 2,3Wp solar panel
- Charging time: 6 hours
- Material ABS + PC anti UV, self-extinguishing
- Selectable CCT



W	K	LUMEN APPARECCHIO lm		VARIANTE	CODICE	EAN	
6	<ul style="list-style-type: none"> 3000 4000 6000 	600	120°	-	YUMA6NK	8031453030902	1/10
Batteria Li-HON 18650 1 cella 3,7V 3000mAh per YUMA6NK					B111037030Z	8031453033521	1

YUMA10NK

Proiettore solare / Solar floodlight



FUNZIONAMENTO

TASTO ON/OFF (1): Premere una volta il tasto per accendere il proiettore. Premerlo nuovamente per cambiare il colore della luce. In questa modalità l'apparecchio rimarrà acceso al 30% fino all'esaurimento della batteria o al sorgere del sole. Tenerlo premuto per 3sec per spegnere l'apparecchio.

TASTO SENSOR MODE (2): In questa modalità il proiettore si accende al rilevamento del movimento con emissione luminosa del 100% se la luce ambientale rilevata tramite il pannello è al di sotto dei 40lux circa. Se non viene rilevato movimento per 30 secondi la luce si spegne.

TASTO ALL NIGHT MODE (3): Fino a quando la luminosità ambientale rilevata è inferiore a circa 40lux il pannello rimane acceso al 10% di emissione luminosa, fino alla scarica della batteria o al sorgere del sole.

TASTO LOW LIGHT SENSOR MODE (4): In questa modalità il proiettore si accende al rilevamento del movimento con il 100% di emissione. Se non viene rilevato movimento per 30 secondi, il proiettore passerà al 10% di emissione fino al movimento rilevato successivo.

OPERATION

ON/OFF KEY (1): Press the button once, to turn on the projector. Press it again to change the color of the light. In this mode, the appliance will remain on at 30% until the battery runs out or the sun rises. Press and hold more than 3 sec to turn off the appliance.

SENSOR MODE KEY (2): In this mode the projector will turn on, when motion is detected, at 100% light output. If the ambient light detected through the panel is below 40lux. If no motion is detected for 30 seconds, the light will turn off.

ALL NIGHT MODE KEY (3): As long as the ambient brightness detected is less than about 40lux, the panel remains on at 10% light output until the battery is discharged or the sun rises.

LOW LIGHT SENSOR MODE KEY (4): In this mode the projector will turn, when motion is detected, at 100% output. If no motion is detected for 30 seconds, the projector will switch to 10% output until the next motion detected.

REGOLABILE / ADJUSTABLE

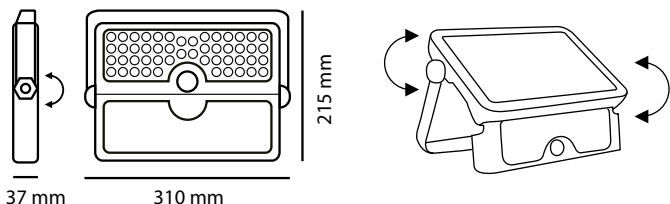

- Proiettore con sensore crepuscolare e rilevatore di presenza PIR
- Facile Installazione: non richiede collegamenti alla rete elettrica
- 2 batterie Li-ION 18650, 3.7V, 3300mAh, 24.42Wh
- Pannello solare 6Wp
- Tempo di ricarica: 8 ore
- Materiale ABS + PC anti UV , autoestinguento
- CCT selezionabile

- Floodlight with dusk sensor and PIR presence detector
- Easy to install: does not require connection to mains energy
- 2x Li-ION 18650 battery, 3.7V, 3300mAh, 24.42Wh
- 6Wp solar panel
- Charging time: 8 hours
- Material ABS + PC anti UV, self-extinguishing
- Selectable CCT



W	K	LUMEN APPARECCHIO lm		VARIANTE	CODICE	EAN	
10	<input type="checkbox"/> 3000 <input type="checkbox"/> 4000 <input type="checkbox"/> 6000	1100	120°	-	YUMA10NK	8031453030919	1/8

Batteria Li-ION 18650 1 cella 3,7V 3300mAh per YUMA10NK (necessari 2 pezzi)

B111037033Z

8031453033538

1

MARBELLA10SUN NEW

BTL CATEGORIA SCONTO 24

Applique solare / Solar wall lamp

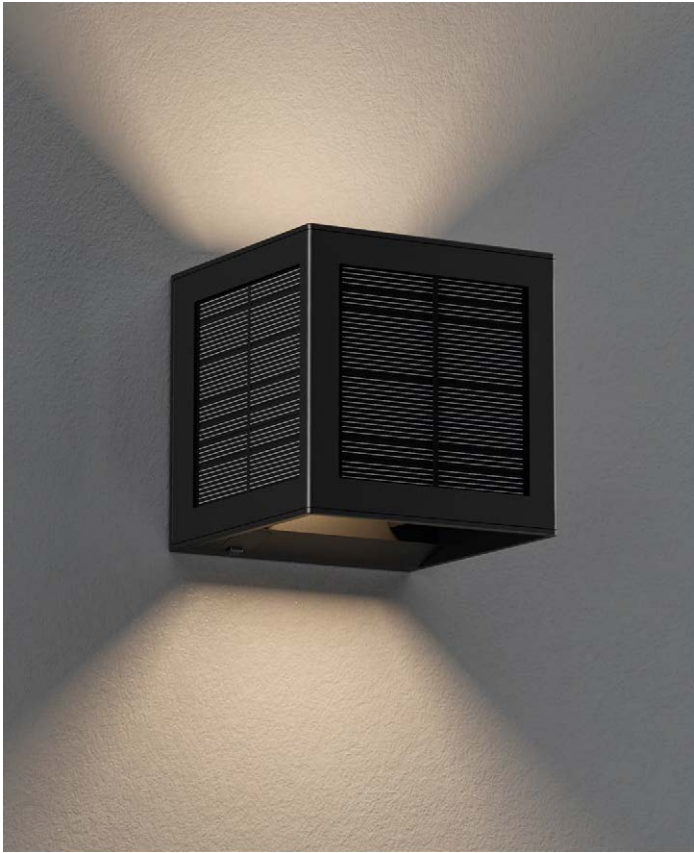

MARBELLAPOLEN
Accessorio / Accessory

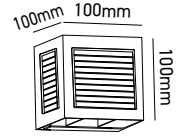

Accessori / Accessories

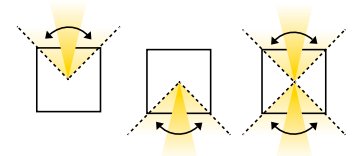
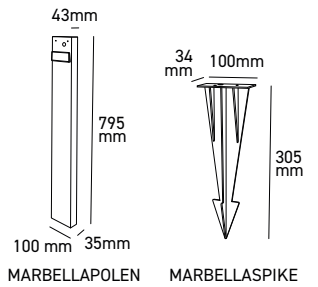

Emissione up & down
attivabile singolarmente.
Fascio regolabile.

Up & down emission individually
selectable. Adjustable beam.

- _ Applique solare da parete in alluminio per esterni con sensore crepuscolare e rilevatore di presenza
- _ Fascio up and down regolabile 0° - 90° senza l'uso di attrezzi
- _ Accensione fasci indipendente
- _ Facile Installazione: non richiede collegamenti alla rete elettrica
- _ Batteria Li-ION 18650, 3.7V, 2600mAh, 9.62Wh
- _ Tempo di ricarica solare: 8 ore, tempo di ricarica con cavo: 4 ore
- _ Completa di cavo di alimentazione USB-C da 1m (alimentatore non incluso)
- _ In opzione: picchetto e paletto per installazione su tutti i tipi superficie
- _ CCT selezionabile

- _ Aluminum solar wall light for outdoor use with dusk sensor and presence detector
- _ Adjustable up and down beam from 0° to 90° without tools
- _ Independent beam ignition
- _ Easy installation: no electrical wiring required
- _ Li-ION 18650 battery, 3.7V, 2600mAh, 9.62Wh
- _ Solar charging time: 8 hours, wired charging time: 4 hours
- _ Supplied with 1m USB-C power cable (power adapter not included)
- _ Optional: spike and stake for installation on all types of surfaces
- _ Selectable CCT



W	K	LUMEN APPARECCHIO lm		VARIANTE	CODICE	EAN	
9	<input checked="" type="checkbox"/> 3000 <input type="checkbox"/> 4000 <input type="checkbox"/> 6000	1000	2x90°	-	MARBELLA10SUN	8031453034603	1
Paletto per MARBELLA10SUN Nero 800mm / Post for MARBELLA10SUN Black 800mm					MARBELLAPOLEN	8031453034740	1
Picchetto per paletto per MARBELLAPOLEN / Stake for MARBELLAPOLEN					MARBELLASPIKE	8031453032449	1
Batteria Li-ION 18650 1 cella 3,7V 2600mAh per MARBELLA9SUN e MARBELLA10SUN					B111037026A	8031453033514	1

FUNZIONAMENTO

Sul retro dell'apparecchio sono presenti 4 selettori utili a impostare il proiettore solare secondo i parametri preferiti: CCT, soglia di intervento, tempo di accensione e modalità di funzionamento.

CCT: 3000K - 4000K - 6000K

Soglia di intervento: 5-30 lux

Tempo di accensione: 20-120 secondi

Modalità di funzionamento:

- OFF: apparecchio spento
- ON: apparecchio sempre acceso al 25% di emissione luminosa se la luminosità ambientale è al di sotto della soglia di intervento impostata
- AUTO: quando la luminosità ambientale è al di sotto della soglia di intervento impostata, l'apparecchio si accenderà al 100% dell'emissione luminosa quando viene rilevato un movimento nel raggio di rilevamento del sensore. Si spengerà passato il tempo di accensione, impostato in precedenza, dopo l'ultimo movimento rilevato
- DIM: quando la luminosità ambientale è al di sotto della soglia di intervento impostata, l'apparecchio si accenderà al 100% dell'emissione luminosa quando viene rilevato un movimento nel raggio di rilevamento del sensore. Passerà al 5% di emissione luminosa passato il tempo di accensione, impostato in precedenza, dopo l'ultimo movimento rilevato.

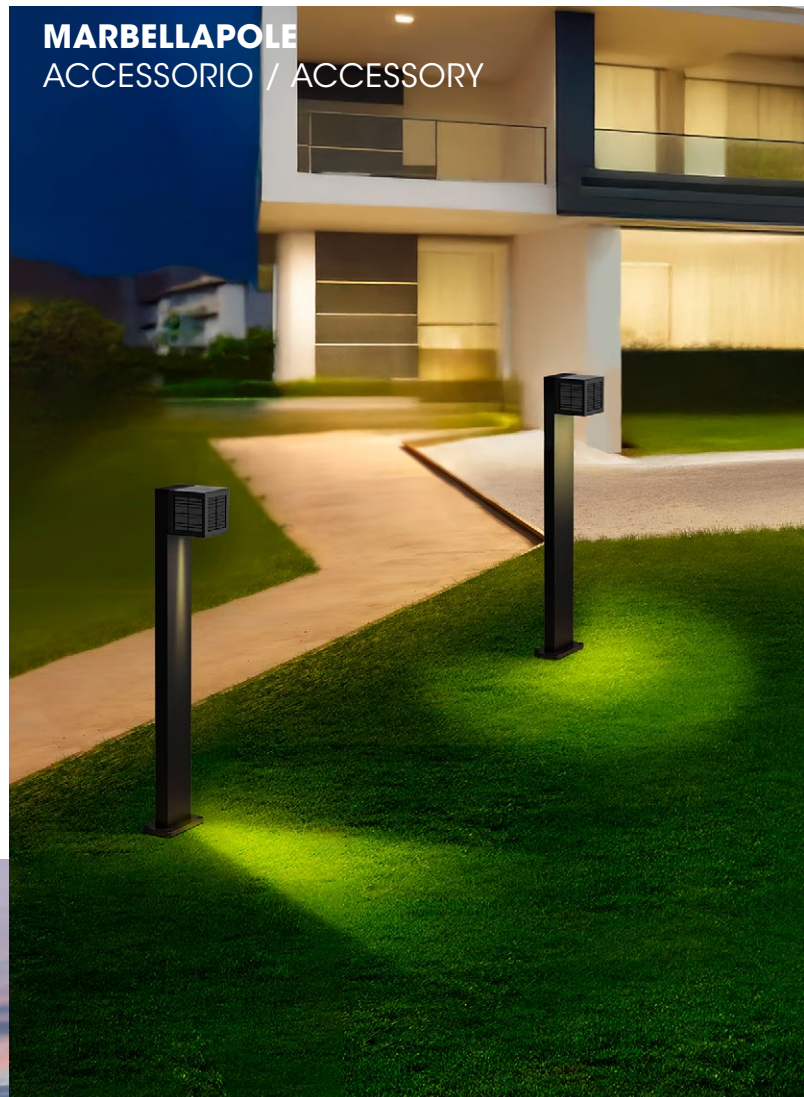

MARBELLAPOLE
ACCESSORIO / ACCESSORY

OPERATION

On the back of the fixture, there are 4 selectors to configure the solar spotlight according to preferred settings: CCT, activation threshold, lighting duration, and operating mode.

CCT: 3000K - 4000K - 6000K

Intervention threshold: 5-30 lux

Lighting duration: 20-120 seconds

Operating modes:

- OFF: fixture off
- ON: fixture always on at 25% brightness when ambient light is below the set threshold
- AUTO: when ambient light is below the set threshold, the fixture turns on at 100% brightness upon motion detection within the sensor range and turns off after the set lighting duration following the last detected movement
- DIM: when ambient light is below the set threshold, the fixture turns on at 100% brightness upon motion detection within the sensor range and turns to 5% brightness after the set lighting duration following the last detected movement.

MARBELLA9SUN AGGIORNATO

BTL CATEGORIA SCONTO 24

Applique solare / Solar wall lamp

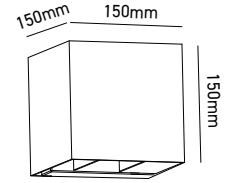

Accessori / Accessories

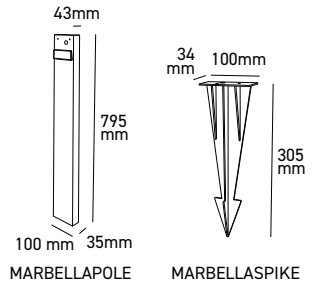

MARBELLAPOLEC
Accessorio / Accessory

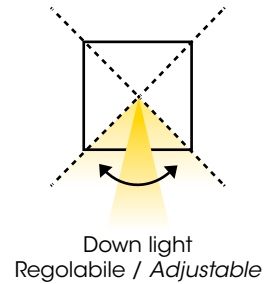

- _ Applique da parete in alluminio per esterni con sensore crepuscolare e rilevatore di presenza a microonde
- _ Fascio regolabile 0° - 95° senza l'uso di attrezzi
- _ Scala graduata per regolazione dell'ampiezza del fascio
- _ Facile Installazione: non richiede collegamenti alla rete elettrica
- _ Batteria Li-ION 18650, 3.7V, 2600mAh, 9.62Wh
- _ Tempo di ricarica: 6 ore
- _ In opzione: picchetto e paletto per installazione su tutti i tipi superficie

- _ Outdoor aluminum wall light with dusk sensor and microwave presence detector
- _ Individually adjustable light beam 0°-95° no tools needed
- _ Graduated scale to adjust the beam width
- _ Easy to install: does not require connection to mains energy
- _ Li-ION 18650 battery, 3.7V, 2600mAh, 9.62Wh
- _ Charging time: 6 hours
- _ Optional: spike and stake for installation on all types of surfaces



W	K	LUMEN APPARECCHIO lm		VARIANTE	CODICE	EAN		
9		3000	670	95°	<input type="checkbox"/> BIANCO / WHITE	MARBELLA9SUNB2	8031453032142	1/6
9	<input type="checkbox"/>	4000	670	95°	<input type="checkbox"/> BIANCO / WHITE	MARBELLA9SUNB	8031453030773	1/6
9		3000	620	95°	<input checked="" type="checkbox"/> ANTRACITE / ANTHRACITE	MARBELLA9SUNG2	8031453032166	1/6
9	<input type="checkbox"/>	4000	620	95°	<input checked="" type="checkbox"/> ANTRACITE / ANTHRACITE	MARBELLA9SUNG	8031453030780	1/6
9		3000	610	95°	<input checked="" type="checkbox"/> CORTEN	MARBELLA9SUNC2	8031453032159	1/6
9	<input type="checkbox"/>	4000	610	95°	<input checked="" type="checkbox"/> CORTEN	MARBELLA9SUNC	8031453030797	1/6
Paletto per MARBELLA9SUN Corten 800mm / Pole for MARBELLA9SUN Corten 800mm					MARBELLAPOLEC	8031453032425	1	
Paletto per MARBELLA9SUN Antracite 800mm / Pole for MARBELLA9SUN Anthracite 800mm					MARBELLAPOLEG	8031453032432	1	
Picchetto per paletto per MARBELLAPOLE / Stake for MARBELLAPOLE					MARBELLASPIKE	8031453032449	1	
Batteria Li-ION 18650 1 cella 3,7V 2600mAh per MARBELLA9SUN e MARBELLA10SUN					B111037026A	8031453033514	1	

NEW

FUNZIONAMENTO

Per passare da una modalità all'altra tenere premuto il pulsante ON/OFF per 3 secondi mentre è acceso l'apparecchio, quest'ultimo lampeggerà per confermare il passaggio alla modalità successiva. Il pannello solare funge anche da sensore crepuscolare e farà attivare l'apparecchio al di sotto dei 15lux.

Modalità 1: Se viene rilevato un movimento, l'apparecchio si accende al 100%. Se non viene rilevato nessun movimento per 30 secondi, l'emissione luminosa passa automaticamente a 25lm (3% di emissione).

Modalità 2: Se viene rilevato un movimento, l'apparecchio si accende al 100%. Se non viene rilevato movimento per 30 secondi, si spegne.

Modalità 3: L'apparecchio rimarrà sempre acceso al 10% di emissione (55 lumen) finché la luminosità ambientale non supererà i 15 lux.

MARBELLAPOLE
 ACCESSORIO / ACCESSORY
**OPERATION**

To switch between modes, press and hold the ON/OFF button for 3 seconds while the fixture is switched on, it will flash to confirm the switch to the next mode. The solar panel also acts as a dusk sensor and will activate the fixture below 15lux.

Mode 1: If motion is detected, the fixture switches on at 100% emission. If no motion is detected for 30 seconds, the light output automatically switches to 25lm (3% of light output).

Mode 2: If motion is detected, the fixture switches on at 100% emission. If no movement is detected for 30 seconds, it will turn off.

Mode 3: The luminaire will always remain on at 10% output (55 lumen) as long as the ambient brightness does not exceed 15 lux.

YUMA350P

BTL CATEGORIA SCONTO 24

Palo solare da giardino / Garden solar bollard light



- _ Palletto solare da giardino con sensore crepuscolare
- _ Corpo in fusione di alluminio e diffusore in policarbonato
- _ Batteria di alta qualità LiFePO4 3,2V, 6000mAh, 19,2Wh
- _ Pannello solare 4,5Wp
- _ Tempo di ricarica: 7 ore
- _ Curva di emissione luminosa ottimizzata nel periodo di funzionamento
- _ CCT selezionabile
- _ Picchetto per installazione su terreno venduto separatamente

- _ Solar bollard with dusk sensor
- _ Die-cast aluminum body and polycarbonate diffuser
- _ LiFePO4 high quality battery 3,2V, 6000mAh, 19,2Wh
- _ 4,5Wp solar panel
- _ Charging time: 7 hours
- _ Optimized light output curve over the working period
- _ Selectable CCT
- _ Ground installation spike sold separately



W	K	LUMEN APPARECCHIO lm		VARIANTE	CODICE	EAN	
2,8	<input type="checkbox"/> 3000 <input type="checkbox"/> 4000	350	120	-	YUMA350P	8031453031206	1/4
Picchetto per YUMA350P e YUMA1200P / Ground spike for YUMA350P and YUMA1200P					YUMASPIKE	8031453031305	1
Batteria LiFePO4 18730 3 celle 3,2V 6000mAh per YUMA350P					B222032070A	8031453033668	1

FUNZIONAMENTO

Premere il tasto per accendere il proiettore e cambiare il colore della luce da 3000K a 4000K. Nel passaggio da un CCT all'altro l'apparecchio viene spento.

Il proiettore si accenderà al tramonto e rimarrà acceso fino all'esaurimento della batteria, al sorgere del sole o comunque per un massimo di 12 ore.

L'apparecchio è dotato di un controllore che automaticamente gestisce l'emissione luminosa con il progredire della notte e funziona come segue:

- 1° ora / 100% di emissione
- 2° ora / 80% di emissione
- 3°-4° ora / 60% di emissione
- 5°-7° ora / 40% di emissione
- 8°-12° ora / 30% di emissione



OPERATION

Press the key to turn on the projector and change the light color from 3000K to 4000K. When switching from one CCT to another, the device is switched off.

The projector will turn on at dusk and will remain on until the battery runs out, the sun rises, or otherwise for up to 12 hours.

The luminaire is equipped with a controller that automatically manages the light output as the night progresses and works as follows:

- 1° hour / 100% brightness
- 2° hour / 80% brightness
- 3°-4° hour / 60% brightness
- 5°-7° hour / 40% brightness
- 8°-12° hour / 30% brightness

YUMA1200P

BTL CATEGORIA SCONTO 24

Palo solare da giardino / Garden solar bollard light

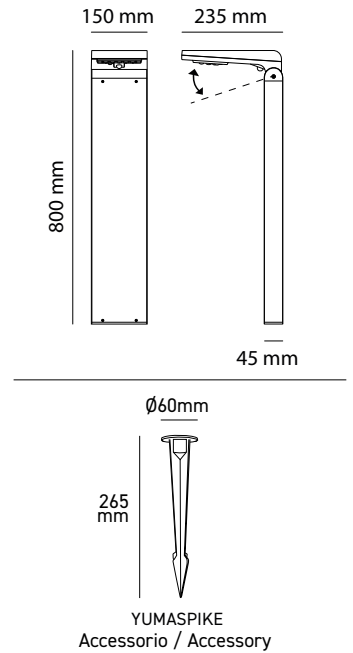

- _ Paletto solare da giardino con sensore crepuscolare e rilevatore di presenza PIR
- _ Corpo in fusione di alluminio e diffusore in policarbonato
- _ Batteria di alta qualità LiFePO4 3,2V, 8000mAh, 25,6Wh
- _ Pannello solare 5Wp
- _ Tempo di ricarica: 8 ore
- _ 2 modalità di funzionamento
- _ Pannello orientabile di 15°
- _ Picchetto per installazione su terreno venduto separatamente

- _ Solar bollard with dusk sensor and PIR presence detector
- _ Die-cast aluminum body and polycarbonate diffuser
- _ LiFePO4 high quality battery 3,2V, 8000mAh, 25,6Wh
- _ 5Wp solar panel
- _ Charging time: 8 hours
- _ 2 operating modes
- _ 15° adjustable panel
- _ Ground installation spike sold separately



W	K	LUMEN APPARECCHIO lm		VARIANTE	CODICE	EAN	
7,5	4000	1200	120	-	YUMA1200P	8031453031190	1/4
Picchetto per YUMA350P e YUMA1200P / Ground spike for YUMA350P and YUMA1200P					YUMASPIKE	8031453031305	1
Batteria LiFePO4 18730 4 celle 3,2V 8000mAh per YUMA1200P					B234032080A	8031453033675	1

FUNZIONAMENTO

Premere il tasto per accendere il proiettore e passare da una modalità di funzionamento all'altra. Nel passaggio da una modalità all'altra l'apparecchio viene spento. Le due modalità di funzionamento sono: "modalità sensore" e "modalità luce costante". In tutte le modalità il proiettore si spegne automaticamente dopo 12 ore di accensione.

MODALITÀ SENSORE: dopo il tramonto, quando viene rilevato movimento l'apparecchio si accende al 100% dell'emissione luminosa. Dopo 20 secondi dall'ultimo movimento rilevato passa al 5% di emissione luminosa.

MODALITÀ LUCE COSTANTE: il sensore di movimento è disabilitato. Dopo il tramonto, l'apparecchio emetterà luce costante al 25% di emissione luminosa.



OPERATION

Press the button to turn on the projector and switch between operating modes. When switching from one mode to another, the appliance is switched off. The two modes of operation are: "sensor mode" and "constant light mode". In all modes, the projector will automatically turn off after 12 hours of power-on.

SENSOR LIGHTING MODE: after sunset, when motion is detected, the fixture switches on at 100% of the light output. After 20 seconds from the last motion detected, it switches to 5% light output.

CONSTANT LIGHTING MODE: the motion sensor is disabled. After sunset, the fixture will emit constant light at 25% light output.

CLAY NEW

BTL CATEGORIA SCONTO 24

Applique solare / Solar wall lamp

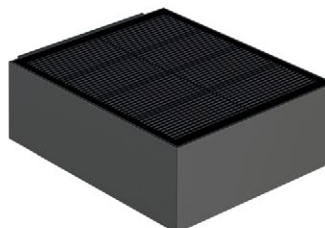
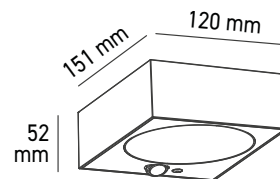

- _ Applique da parete in policarbonato per esterni con sensore crepuscolare e rilevatore di presenza PIR
- _ Facile installazione: non richiede collegamenti alla rete elettrica
- _ Batteria Li-ION 18650, 3,7V, 2000mAh, 7,4Wh
- _ Pannello solare 2Wp
- _ Tempo di ricarica: 5 ore
- _ Materiale ABS + PC anti UV , autoestinguento
- _ 4 modalità di funzionamento

- _ *Outdoor polycarbonate wall light with dusk sensor and PIR presence detector*
- _ *Easy installation: mains connection not needed*
- _ *High quality Li-ION 18650 battery, 3.7V, 2000mAh, 7.4Wh*
- _ *2Wp solar panel*
- _ *Charging time: 5 hours*
- _ *Self-extinguishing ABS + PC anti UV material*
- _ *4 working mode*



W	K	LUMEN APPARECCHIO lm		VARIANTE	CODICE	EAN	
5,2	3000	1000	120°	NERO / BLACK	CLAYN2	8031453033088	1/24
5,2	4000	1000	120°	NERO / BLACK	CLAYN	8031453033071	1/24
Batteria Li-ION 18650 1 cella 3,7V 2000mAh per CLAY MOON YUCCA YUCCAP					B111037020A	8031453033484	1

FUNZIONAMENTO

Premere il tasto in maniera prolungata per circa 2 secondi per agire su accensione e spegnimento del proiettore. Effettuare una pressione singola per passare da una modalità di funzionamento alla successiva. Alla prima accensione l'apparecchio si accenderà in modalità 1.

Programmazione flusso luminoso: in qualsiasi modalità, premere due volte rapidamente il pulsante. L'apparecchio lampeggerà due volte per segnalare l'ingresso in modalità flusso luminoso programmabile. In questa modalità, ad ogni pressione del pulsante il flusso luminoso dell'apparecchio aumenterà del 10% dallo 0% al 100% per poi ricominciare da 0%. In base alla modalità di funzionamento in uso al momento della programmazione del flusso luminoso, cambierà il parametro che verrà modificato come indicato nel funzionamento delle singole modalità.

Per uscire dalla modalità è necessario non premere il pulsante per 5 secondi, l'apparecchio lampeggerà velocemente per 3 volte a conferma dell'uscita dalla modalità luminosità programmabile.

Per resettare le impostazioni di default tenere premuto il pulsante per 6 secondi, l'apparecchio lampeggerà velocemente per 5 volte a conferma dell'avvenuto reset e si setterà in modalità 1.

MODALITÀ 1: Il proiettore rimarrà acceso al 20% di emissione dal tramonto all'alba o fino ad esaurimento della carica della batteria. La modalità di programmazione del flusso luminoso porterà ad un aumento del 10% ad ogni pressione del tasto.

MODALITÀ 2: Il proiettore rimarrà acceso al 10% di emissione dal tramonto all'alba o fino ad esaurimento della carica della batteria. Quando verrà rilevato un movimento nel raggio di 1-5 metri si accenderà al 100% dell'emissione e rimarrà acceso per 30 secondi successivi all'ultimo movimento rilevato per poi tornare al 10% di emissione. La modalità di programmazione del flusso luminoso permetterà di aumentare del 10% ad ogni pressione del tasto il flusso relativo all'accensione nel caso di rilevamento di presenza.

MODALITÀ 3: Il proiettore rimarrà spento. Quando, tra il tramonto e l'alba, verrà rilevato un movimento nel raggio di 1-5 metri si accenderà al 100% dell'emissione e rimarrà acceso per 30 secondi successivi all'ultimo movimento rilevato per poi spegnersi nuovamente. La modalità di programmazione del flusso luminoso permetterà di aumentare del 10% ad ogni pressione del tasto il flusso relativo alla funzione fissa finché non avviene il rilevamento di presenza.

MODALITÀ 4: Il proiettore rimarrà acceso al 100% di emissione dal tramonto all'alba o fino ad esaurimento della carica della batteria. La modalità di programmazione del flusso luminoso porterà ad un aumento del 10% ad ogni pressione del tasto.



CLAY



OPERATION

Press and hold the button for about 2 seconds to turn the projector on or off. Press the button once to switch to the next operating mode. Upon first activation, the device will start in Mode 1.

Light Flow Programming: In any mode, press the button twice quickly. The device will flash twice to indicate entry into the programmable light flow mode. In this mode, each press of the button will increase the light flow by 10%, from 0% to 100%, and then restart from 0%. Depending on the operating mode active at the time of light flow programming, the parameter being adjusted will change as described in the operation of each mode.

To exit the mode, do not press the button for 5 seconds; the device will flash quickly 3 times to confirm the exit from the programmable brightness mode.

To reset the default settings, press and hold the button for 6 seconds; the device will flash quickly 5 times to confirm the reset and will set itself to Mode 1.

MODE 1: the projector will remain on at 20% brightness from sunset to sunrise or until the battery is fully discharged. The light flow programming mode will increase brightness by 10% with each press of the button.

MODE 2: the projector will remain on at 10% brightness from sunset to sunrise or until the battery is fully discharged. When motion is detected within a range of 1-5 meters, it will turn on at 100% brightness and remain on for 30 seconds after the last detected motion before returning to 10% brightness. The light flow programming mode will allow an increase of 10% with each press of the button for the brightness level activated upon motion detection.

MODE 3: the projector will remain off. When motion is detected within a range of 1-5 meters between sunset and sunrise, it will turn on at 100% brightness and remain on for 30 seconds after the last detected motion before turning off again. The light flow programming mode will allow an increase of 10% with each press of the button for the fixed brightness level until motion is detected.

MODE 4: the projector will remain on at 100% brightness from sunset to sunrise or until the battery is fully discharged. The light flow programming mode will increase brightness by 10% with each press of the button.

AVENUE

BTL CATEGORIA SCONTO 24

Applique solare / Solar wall lamp

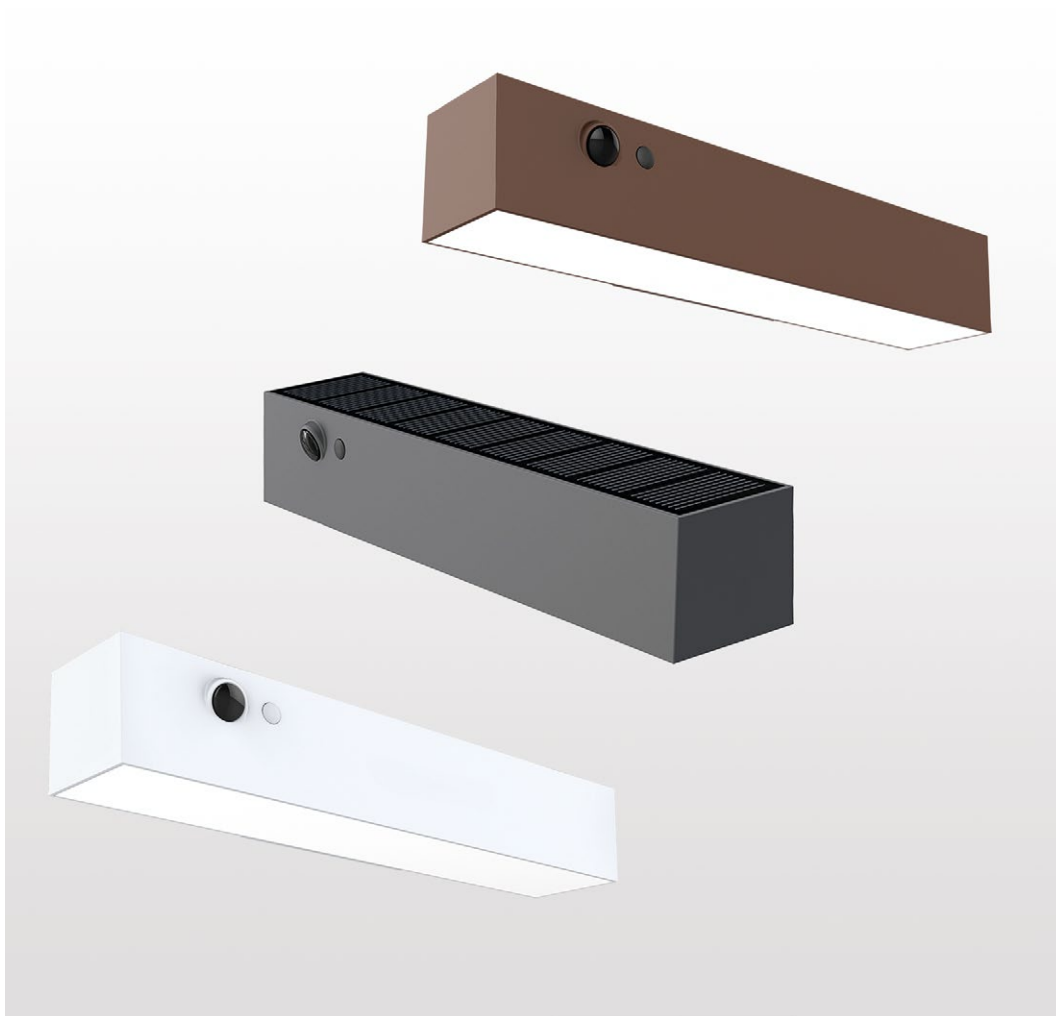
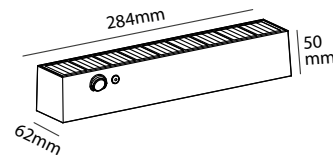

- _ Applique da parete in policarbonato per esterni con sensore crepuscolare e rilevatore di presenza PIR
- _ Facile Installazione: non richiede collegamenti alla rete elettrica
- _ Batteria Li-ION 18650, 3.7V, 2000mAh, 7.4Wh
- _ Pannello solare 1,5Wp
- _ Tempo di ricarica: 6 ore
- _ 4 modalità di funzionamento

- _ *Outdoor polycarbonate wall light with dusk sensor and PIR presence detector*
- _ *Easy installation: mains connection not needed*
- _ *Li-ION 18650 battery, 3.7V, 2000mAh, 7.4Wh*
- _ *1,5Wp solar panel*
- _ *Charging time: 6 hours*
- _ *4 working mode*



W	K	LUMEN APPARECCHIO lm		VARIANTE	CODICE	EAN		
5,2		3000	1000	120°	BIANCO / WHITE	AVENUEB2	8031453032029	1/36
5,2		4000	1000	120°	BIANCO / WHITE	AVENUEB	8031453030995	1/36
5,2		3000	1000	120°	NERO / BLACK	AVENUEN2	8031453032043	1/36
5,2		4000	1000	120°	NERO / BLACK	AVENUEN	8031453031008	1/36
5,2		3000	1000	120°	CORTEN	AVENUEC2	8031453032036	1/36
5,2		4000	1000	120°	CORTEN	AVENUEC	8031453031015	1/36

FUNZIONAMENTO

Premere il tasto in maniera prolungata per circa 2 secondi per agire su accensione e spegnimento del proiettore. Premerlo nuovamente per passare da una modalità di funzionamento ad un'altra. Alla prima accensione l'apparecchio si accenderà in modalità 1.

MODALITÀ 1: Il proiettore rimarrà acceso al 100% di emissione dal tramonto all'alba o fino ad esaurimento della carica della batteria.

MODALITÀ 2: Il proiettore rimarrà acceso al 25% di emissione dal tramonto all'alba o fino ad esaurimento della carica della batteria.

MODALITÀ 3: Il proiettore rimarrà acceso al 10% di emissione dal tramonto all'alba o fino ad esaurimento della carica della batteria. Quando verrà rilevato un movimento nel raggio di 1-5 metri si accenderà al 100% dell'emissione e rimarrà acceso per 30 secondi successivi all'ultimo movimento rilevato.

MODALITÀ 4: Il proiettore rimarrà spento. Quando verrà rilevato un movimento nel raggio di 1-5 metri si accenderà al 100% dell'emissione e rimarrà acceso per 30 secondi successivi all'ultimo movimento rilevato.

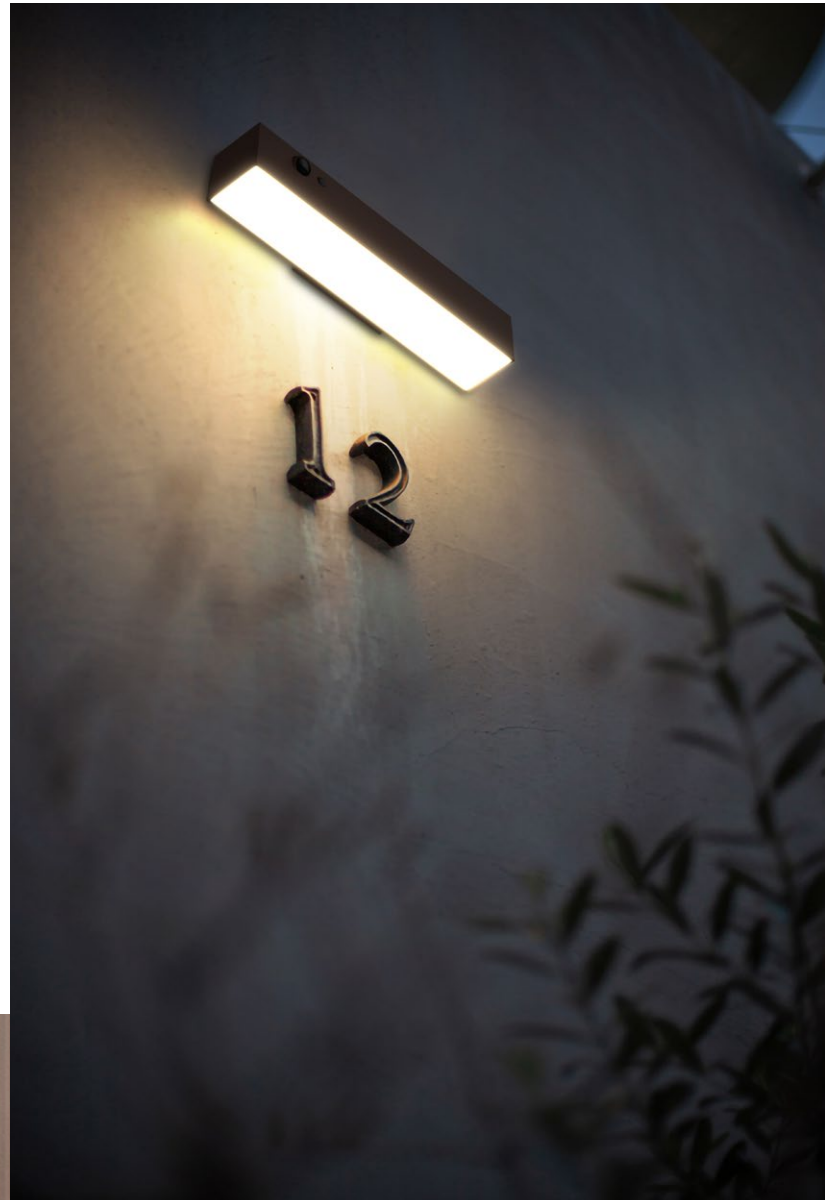
**OPERATION**

Press the button for about 2 seconds to turn the projector on and off. Press it again to switch between operating modes. When the appliance is first switched on, it will turn on in mode 1.

MODE 1: The projector will remain on at 100% emission from dusk to dawn or until depletion of battery power.

MODE 2: The projector will remain on at 25% emission from dusk to dawn or until depletion of battery power.

MODE 3: The projector will remain on at 10% emission from dusk to dawn or until depletion of battery power. When motion within 1-5 meters is detected, it will light up at 100% of the emission and remain on for 30 seconds following the last detected movement.

MODE 4: The projector will remain off. When motion within 1-5 meters is detected, it will light up at 100% of the emission and remain on for 30 seconds following the last detected movement.

MOON

BTL CATEGORIA SCONTO 24

Applique solare / Solar wall lamp

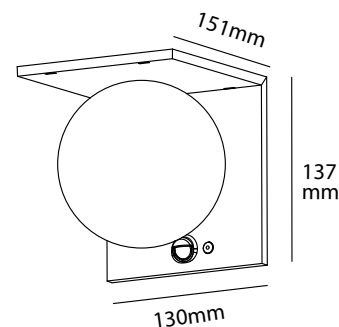

- _ Applique da parete in policarbonato per esterni con sensore crepuscolare e rilevatore di presenza PIR
- _ Facile Installazione: non richiede collegamenti alla rete elettrica
- _ Batteria Li-ION 18650, 3,7V, 2000mAh, 7,4Wh
- _ Pannello solare 1,5Wp
- _ Tempo di ricarica: 6 ore
- _ 4 modalità di funzionamento

- _ *Outdoor polycarbonate wall light with dusk sensor and PIR presence detector*
- _ *Easy installation: mains connection not needed*
- _ *Li-ION 18650 battery, 3,7V, 2000mAh, 7,4Wh*
- _ *1,5Wp solar panel*
- _ *Charging time: 6 hours*
- _ *4 working mode*



W	K	LUMEN APPARECCHIO lm		VARIANTE	CODICE	EAN		
5,2		3000	1000	270°	<input type="checkbox"/> BIANCO / WHITE	MOONB2	8031453032050	1/18
5,2	<input type="checkbox"/>	4000	1000	270°	<input type="checkbox"/> BIANCO / WHITE	MOONB	8031453031152	1/18
5,2		3000	1000	270°	<input checked="" type="checkbox"/> NERO / BLACK	MOONN2	8031453032067	1/18
5,2	<input type="checkbox"/>	4000	1000	270°	<input checked="" type="checkbox"/> NERO / BLACK	MOONN	8031453031022	1/18
Batteria Li-ION 18650 1 cella 3,7V 2000mAh per CLAY MOON YUCCA YUCCAP					B111037020A	8031453033484	1	



FUNZIONAMENTO

Premere il tasto in maniera prolungata per circa 2 secondi per agire su accensione e spegnimento del proiettore. Premerlo nuovamente per passare da una modalità di funzionamento ad un'altra. Alla prima accensione l'apparecchio si accenderà in modalità 1.

MODALITÀ 1: Il proiettore rimarrà acceso al 100% di emissione dal tramonto all'alba o fino ad esaurimento della carica della batteria.

MODALITÀ 2: Il proiettore rimarrà acceso al 25% di emissione dal tramonto all'alba o fino ad esaurimento della carica della batteria.

MODALITÀ 3: Il proiettore rimarrà acceso al 10% di emissione dal tramonto all'alba o fino ad esaurimento della carica della batteria. Quando verrà rilevato un movimento nel raggio di 1-5 metri si accenderà al 100% dell'emissione e rimarrà acceso per 30 secondi successivi all'ultimo movimento rilevato.

MODALITÀ 4: Il proiettore rimarrà spento. Quando verrà rilevato un movimento nel raggio di 1-5 metri si accenderà al 100% dell'emissione e rimarrà acceso per 30 secondi successivi all'ultimo movimento rilevato.

OPERATION

Press the button for about 2 seconds to turn the projector on and off. Press it again to switch between operating modes. When the appliance is first switched on, it will turn on in mode 1.

MODE 1: The projector will remain on at 100% emission from dusk to dawn or until depletion.

MODE 2: The projector will remain on at 25% emission from dusk to dawn or until depletion of battery power.

MODE 3: The projector will remain on at 10% emission from dusk to dawn or until depletion of battery power. When motion within 1-5 meters is detected, it will light up at 100% of the emission and remain on for 30 seconds following the last detected movement.

MODE 4: The projector will remain off. When motion within 1-5 meters is detected, it will light up at 100% of the emission and remain on for 30 seconds following the last detected movement.

YUCCA

BTL CATEGORIA SCONTO 24

Lanterna solare / Solar lantern

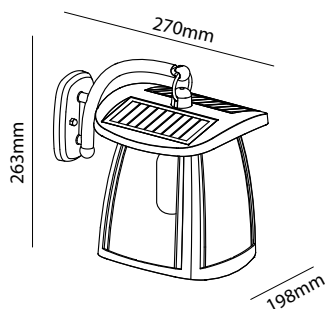

- Lanterna appendibile in policarbonato per esterni con sensore crepuscolare
- Facile Installazione: non richiede collegamenti alla rete elettrica
- Batteria Li-ION 18650, 3.7V, 2000mAh, 7.4Wh
- Pannello solare 2Wp
- Tempo di ricarica: 5 ore
- 4 modalità di funzionamento
- Sorgente 3000K opzionale

FUNZIONAMENTO

Premere il tasto in maniera prolungata per circa 1,5 secondi per agire su accensione e spegnimento del proiettore. Premerlo nuovamente per passare da una modalità di funzionamento ad un'altra.

MODALITÀ 1: Il proiettore rimarrà acceso al 25% di emissione dal tramonto all'alba, o fino all'esaurimento della batteria.

MODALITÀ 2: Il proiettore rimarrà acceso al 50% di emissione dal tramonto all'alba, o fino all'esaurimento della batteria.

MODALITÀ 3: Il proiettore rimarrà acceso al 75% di emissione dal tramonto all'alba, o fino all'esaurimento della batteria.

MODALITÀ 4: Il proiettore rimarrà acceso al 100% di emissione dal tramonto all'alba, o fino all'esaurimento della batteria.

OPERATION

Press the button for about 1.5 seconds to turn the projector on and off. Press it again to switch between operating modes.

MODE 1: The projector will remain on at 25% emission from dusk to dawn, or until the battery runs out.

MODE 2: The projector will remain on at 50% emission from dusk to dawn, or until the battery runs out.

MODE 3: The projector will remain on at 75% emission from dusk to dawn, or until the battery runs out.

MODE 4: The projector will remain on at 100% emission from dusk to dawn, or until the battery runs out.

- Outdoor polycarbonate hangable lantern with dusk sensor
- Easy installation: mains connection not needed
- Li-ION 18650 battery, 3.7V, 2000mAh, 7.4Wh
- Solar panel 2Wp
- Charging time: 5 hours
- 4 working mode
- Optional 3000K bulb



W	K	LUMEN APPARECCHIO lm		VARIANTE	CODICE	EAN	
1,8	4000	350	330°	NERO / BLACK	YUCCA	8031453030971	1/4
Lampada Stick per YUCCA 600lm 5V E27 WW - 3000K					YUCCABULB2	8031453032081	1
Lampada Stick per YUCCA 600lm 5V E27 CW - 4000K					YUCCABULB	8031453032074	1
Batteria Li-ION 18650 1 cella 3,7V 2000mAh per CLAY MOON YUCCA YUCCAP					B111037020A	8031453033484	1



YUCCA

YUCCAP

BTL CATEGORIA SCONTO 24

Lanterna solare con paletto / Solar lantern with pole

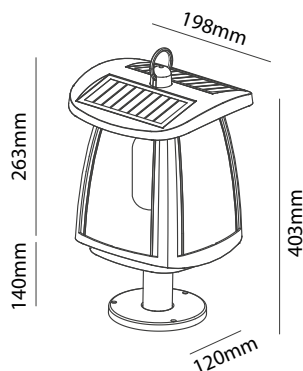

- _ Lanterna con paletto in policarbonato per esterni con sensore crepuscolare
- _ Facile Installazione: non richiede collegamenti alla rete elettrica
- _ Batteria Li-ION 18650, 3.7V, 2000mAh, 7.4Wh
- _ Pannello solare 2Wp
- _ Tempo di ricarica: 5 ore
- _ 4 modalità di funzionamento
- _ Sorgente 3000K opzionale

FUNZIONAMENTO

Premere il tasto in maniera prolungata per circa 1,5 secondi per agire su accensione e spegnimento del proiettore. Premerlo nuovamente per passare da una modalità di funzionamento ad un'altra.

MODALITÀ 1: Il proiettore rimarrà acceso al 25% di emissione dal tramonto all'alba, o fino all'esaurimento della batteria.

MODALITÀ 2: Il proiettore rimarrà acceso al 50% di emissione dal tramonto all'alba, o fino all'esaurimento della batteria.

MODALITÀ 3: Il proiettore rimarrà acceso al 75% di emissione dal tramonto all'alba, o fino all'esaurimento della batteria.

MODALITÀ 4: Il proiettore rimarrà acceso al 100% di emissione dal tramonto all'alba, o fino all'esaurimento della batteria.

OPERATION

Press the button for about 1.5 seconds to turn the projector on and off. Press it again to switch between operating modes.

MODE 1: The projector will remain on at 25% emission from dusk to dawn, or until the battery runs out.

MODE 2: The projector will remain on at 50% emission from dusk to dawn, or until the battery runs out.

MODE 3: The projector will remain on at 75% emission from dusk to dawn, or until the battery runs out.

MODE 4: The projector will remain on at 100% emission from dusk to dawn, or until the battery runs out.

- _ Outdoor polycarbonate pole lantern with dusk sensor
- _ Easy installation: mains connection not needed
- _ Lithium-Ion battery 3.7V, 2000mAh, 7.4Wh
- _ 2Wp solar panel
- _ Charging time: 5 hours
- _ 4 working mode
- _ Optional 3000K bulb



W	K	LUMEN APPARECCHIO lm		VARIANTE	CODICE	EAN	
1,8	4000	350	330°	NERO / BLACK	YUCCAP	8031453030988	1 / 4
					YUCCABULB2	8031453032081	1
					YUCCABULB	8031453032074	1
					B111037020A	8031453033484	1



YUCCAP

FLAME2N

BTL CATEGORIA SCONTO 24

Torcia a Led effetto fiamma - solare con sensore crepuscolare /
Led torch with flame effect - solar powered & dusk sensor

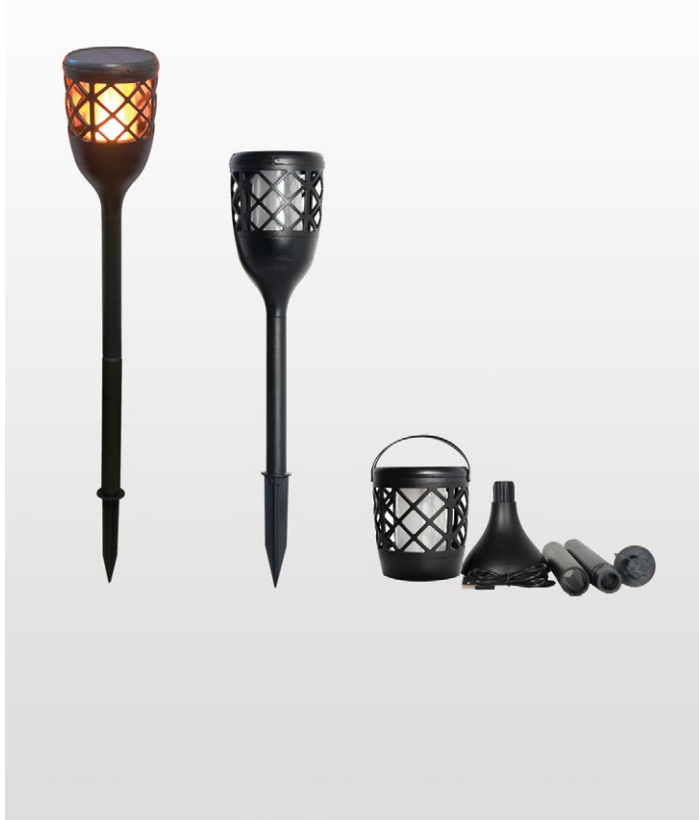

FUNZIONAMENTO

Due modalità di funzionamento.
Premendo il pulsante di accensione una volta si attiva la modalità A: 25% dell'emissione (0,5W), si accende al crepuscolo (≤ 30 lux) e si spegne all'alba (≥ 150 lux) oppure all'esaurimento della carica.

Premendo il pulsante di accensione una seconda volta si attiva la modalità B: 100% dell'emissione (2W), si accende al crepuscolo (≤ 30 lux) e si spegne all'alba (≥ 150 lux) oppure all'esaurimento della carica.

OPERATION

Two selectable working modes.
Pressing the power button once, mode A activates: 0.5W (25% emission), turns on at dusk (≤ 30 lux) and turns off at sunrise (≥ 150 lux) or on low battery.

Pressing the button a second time, mode B activates: 2W (100% emission), turns on at dusk (≤ 30 lux) and turns off at sunrise (≥ 150 lux) or on low battery.

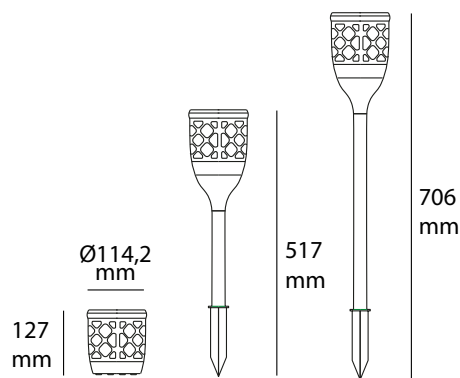

- Effetto fiamma unico e realistico
- Polivalente: adatto sia in giardino che in casa, può essere appeso, appoggiato o posizionato sul paletto in dotazione.
- Due differenti modi di funzionamento
- Ricaricabile tramite pannello solare o porta USB (micro USB)
- Batteria al litio ad alte prestazioni, ampia capacità e lunga durata
- Materiale resistente ai raggi UV ed autoestinguente
- Protezione IP65
- Colore nero

- Unique and realistic flame effect
- Multipurpose: garden and house suited, can be hung, leaned or placed on the included stake
- Two different operating modes
- Rechargeable via solar panel or USB port (micro USB)
- Wide capacity, longer life, high performance lithium battery
- UV-resistant, auto-extinguishing durable material
- IP65 protection
- Black finishing



W	K	LUMEN APPARECCHIO lm		VARIANTE	CODICE	EAN	
2	1500		360°	-	FLAME2N	8031453023232	1/24
Batteria Li-ION 18650 1 cella 3,7V 1200mAh per FLAME2N					B111037012A	8031453033460	1



FLAME2N





SHOT
BOT LIGHTING

PORTATILI E LEISURE / WORKLIGHTS
PORTABLE & LEISURE / WORKLIGHTS



Lampada da lavoro portatile / Portable worklight

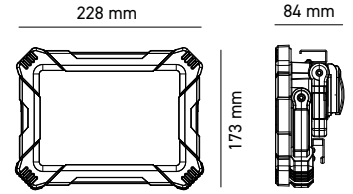

Con 2 prese standard Tedesco 250V 16A VDE /
With 2 German integrated socket



WORK50 è il proiettore portatile ideale per ogni utilizzo, dai cantieri agli eventi outdoor. Compatto, facile da trasportare e progettato per durare, offre un'illuminazione potente e una luce bianca neutra perfetta per ogni applicazione.

- _ Proiettore portatile da cantiere con corpo in alluminio
- _ Due prese standard tedesco 250V 16A VDE sul retro del proiettore
- _ Interruttore a tre posizioni: OFF - 50% - 100%
- _ Cavo H07RN-F3G1.5mm², lunghezza 3 metri

WORK50 is the ideal portable projector for any use, from construction sites to outdoor events. Compact, easy to transport, and built to last, it provides powerful illumination and a neutral white light perfect for any application.

- _ Portable worksite worklight with aluminum body
- _ Two German standard 250V 16A VDE sockets on the back of the worklight
- _ Three-position switch: OFF - 50% - 100%
- _ H07RN-F3G1.5mm² cable, 3 meters in length



W	K	LUMEN APPARECCHIO lm	LUMEN SORGENTE lm		VARIANTE	CODICE	EAN			
50	<input type="checkbox"/>	4000	4500	5500	120°	-	WORK50	8031453032746	1/6	



WORK 50

Proiettore portatile / Worklight

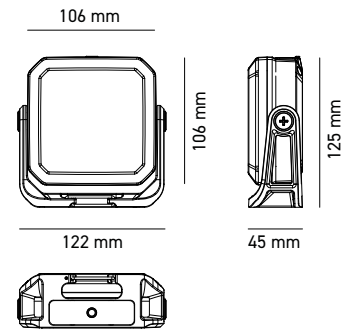

Pannello solare / solar powered



Moschettone integrato / Integrated carabiner



Base magnetica / Magnetic base

Ricaricabile, versatile e resistente, luminosità regolabile e tre tonalità di luce. Il compagno ideale per ogni cantiere o attività outdoor.

- _ Proiettore portatile da cantiere con ricarica USB e solare (cavo USB-C 1m incluso)
- _ Batteria alta qualità Li-Ion 18650, 3.7V, 4400mAh, 16.28Wh
- _ Tripla potenza selezionabile: 25% - 50% - 100%
- _ Tempo di ricarica 6 ore
- _ Tempo di funzionamento da 3 a 12 ore (a seconda della dimmerazione)
- _ Indicatore LED sullo stato di carica della batteria
- _ Funzione powerbank 5V 2A
- _ Possibilità di fissaggio: treppiede, gancio o base magnetica

Rechargeable, versatile, and durable, with adjustable brightness and three light tones. The perfect companion for any construction site or outdoor activity.

- _ Portable worksite projector with USB and solar charging (1m USB-C cable included)
- _ High quality Li-Ion 18650 battery, 3.7V, 4400mAh, 16.28Wh
- _ Triple selectable power: 25% - 50% - 100%
- _ Charging time: 6 hours
- _ Operating time: 3 to 12 hours (depending on dimming level)
- _ LED indicator for battery charge status
- _ 5V 2A powerbank function
- _ Mounting options: tripod, hook, or magnetic base



W	K	LUMEN APPARECCHIO lm	LUMEN SORGENTE lm		VARIANTE	CODICE	EAN	
10	<ul style="list-style-type: none"> 3000 4000 6000 	1000	1250	120°	-	WORK10SUN	8031453032753	1/30

Batteria Li-ION 18650 2 celle 3,7V 4400mAh per WORK10SUN

B112037044A

8031453033576

1

WORK 20 NEW

BTL CATEGORIA SCONTO 24

Lampada da lavoro portatile / Portable worklight

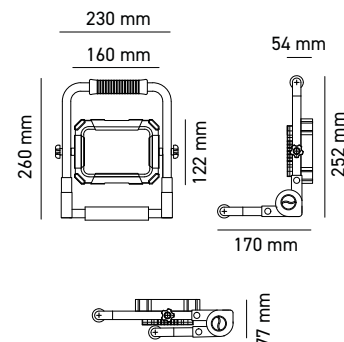

WORK20E unisce potenza e praticità, perfetto per ambienti di lavoro impegnativi grazie alla sua struttura resistente. Ricaricabile tramite USB-C e dotato di funzione powerbank, è pieghevole per un facile trasporto e un ingombro minimo.

WORK20E combines power and practicality, perfect for demanding work environments thanks to its durable structure. Rechargeable via USB-C and equipped with a powerbank function, it is foldable for easy transport and minimal storage space.

- _ Proiettore portatile da cantiere con ricarica USB (cavo USB-C 1m incluso)
- _ Batteria alta qualità Li-Ion 18650, 3.7V, 8800mAh, 32.56Wh
- _ Doppia potenza selezionabile: 50% - 100%
- _ Tempo di ricarica 6 ore
- _ Tempo di funzionamento da 3 a 6 ore (a seconda della dimmerazione)
- _ Indicatore LED sullo stato di carica della batteria
- _ Funzione powerbank 5V 2A

- _ Portable worksite projector with USB charging (1m USB-C cable included)
- _ High quality Li-Ion 18650 battery, 3.7V, 8800mAh, 32.56Wh
- _ Selectable dual power: 50% - 100%
- _ Charging time 6 hours
- _ Operating time from 3 to 6 hours (depending on dimming)
- _ LED indicator for battery charge status
- _ Power bank function 5V 2A



W	K	LUMEN APPARECCHIO lm	LUMEN SORGENTE lm		VARIANTE	CODICE	EAN	
20	<input type="checkbox"/> 4000	2000	2500	120°	-	WORK20E	8031453032760	1/8

Batteria Li-ION 18650 4 celle 3,7V 8800mAh per WORK20E

B114037088A

8031453033583

1

FROG

BTL CATEGORIA SCONTO 16

Proiettore multiuso ricaricabile / Rechargeable multipurpose worklight

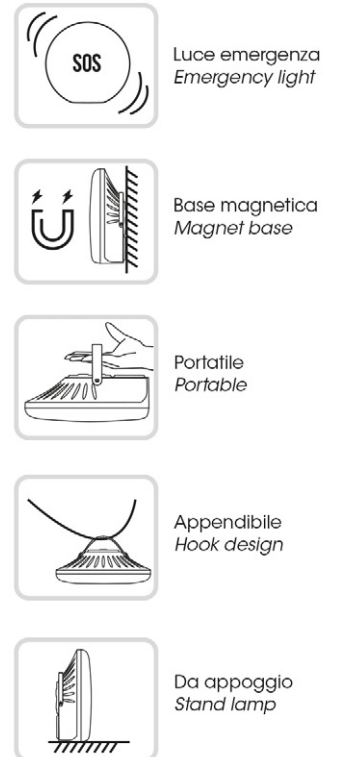
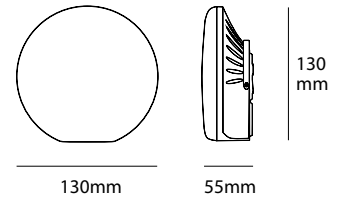

- _ Lampada portatile a batteria IP54
- _ Compatta e leggera, facile da trasportare
- _ Completa di cavo di alimentazione USB-C da 0,5m (alimentatore non incluso)
- _ Temperatura colore, intensità luminosa e funzione SOS controllabili tramite tasti dedicati
- _ Tempo di ricarica 3 ore
- _ Tempo di funzionamento da 7 a 16 ore (a seconda della dimmerazione)
- _ Indicatore led sullo stato di carica della batteria
- _ Funzione powerbank 5V 2A

- _ Portable battery-powered lamp IP54
- _ Compact and lightweight, easy to carry
- _ Supplied with 0,5m USB-C power cable (power adapter not included)
- _ Color temperature, light intensity and SOS function easily settable with dedicated buttons
- _ Charging time 3 hours
- _ Operating time from 7 to 16 hours (depending on dimming)
- _ LED indicator for battery charge status
- _ Power bank function 5V 2A



W	K	LUMEN APPARECCHIO lm	LUMEN SORGENTE lm	VARIANTE	CODICE	EAN	
4	<input type="checkbox"/> 3000 <input type="checkbox"/> 4000 <input type="checkbox"/> 6000	510	530	-	FROG	8031453031435	1/20



IDEALE PER / IDEAL FOR



ATTIVITÀ ALL'APERTO O HOBBY
OUTDOOR OR HOBBY



FROG

Flashlight torcia portatile a led ricaricabile / Portable Rechargeable LED Torch

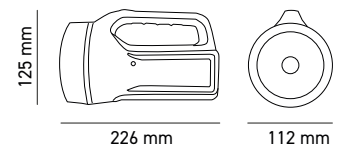

Incluso cavo di ricarica
Charging cable included

- _ Interruttore a due posizioni
- _ Batteria Li-ION 18650, 3.7V, 4000mAh, 16Wh
- _ Tempo di ricarica 12-15 ore
- _ Tempo di funzionamento da 5 a 10 ore
- _ Pratica cinghia tracolla
- _ Caricabatterie da rete integrato nel corpo lampada

- _ *Two-position switch*
- _ *High quality Li-ION 18650 battery, 3.7V, 4000mAh, 16Wh*
- _ *12-15 hours charging time*
- _ *Operating time from 5 to 10 hours*
- _ *Practical shoulder strap*
- _ *Mains charger integrated into the lamp body*



W		VARIANTE	CODICE	EAN	
5	-	-	LED16X	8031453033101	1/10

EXPO WORKLIGHT LED COLORI VARI 9 PZ

BTL CATEGORIA SCONTO 16



- Lampada da lavoro con staffa magnetica orientabile fino a 180°
 - Funzioni: modalità torcia o modalità lanterna
 - Composizione: 9 torce (3 rosse - 3 nere - 3 blu)
 - Corpo in gomma antisdrucciolo e con gancio per sospensione
 - 3W - 250lm
 - Batterie: 3xAAA (incluse)
- Work lamp with magnetic bracket adjustable up to 180°
 - Functions: torch mode or lantern mode
 - Composition: 9 light torches (3 red - 3 black - 3 blue)
 - Body in non-slip rubber and with hook for suspension
 - 3W - 250lm
 - Batteries: 3xAAA (included)

CODICE

EAN



8710478

6435200218827

1/4



SHOT
BOT LIGHTING

FLASH & SPORT LIGHTS





LED BICYCLE FRONT LIGHT

BTL CATEGORIA SCONTO 16



- _ Lampada frontale per bici.
- _ Montaggio a sgancio rapido universale.
- _ Interruttore ON/OFF.
- _ Tre livelli di luminosità: 100%,30%, lampeggiante.
- _ Modalità 6 LED (safety light) premendo il pulsante ON per 3 secondi.
- _ 3W - 150lm.
- _ Batterie: AAA (non include).
- _ Front lamp for bikes
- _ Universal quick release mounting
- _ ON / OFF switch
- _ Three levels of brightness: 100%, 30%, flashing
- _ Mode 6 LED (safety light) by pressing the ON button for 3 seconds
- _ 3W - 150lm
- _ Batteries: AAA (not included)



CODICE	EAN	IMBALLO
8710462	6435200213525	6/72

LED BICYCLE LIGHT SET CON RICARICA USB

BTL CATEGORIA SCONTO 16



- _ Kit luce anteriore + posteriore multiuso per biciclette
- _ Luce frontale 5 W CREE LED, 300 lm - 3 step di regolazione 100/50/30% + intermittente
- _ Luce posteriore COB LED - 2 step di regolazione 100/60% + intermittente
- _ Tempo di ricarica: luce frontale 3.5 h, posteriore 2 h.
- _ Durata luce frontale: 100% 3.5 h, 50% 5.5 h, 30%, 6.5 h, flash 50% 6.5 h.
- _ Luce posteriore: 100 % 4 h, 60 % 6 h, flash 100 % 8.5 h.
- _ Ricaricabile tramite USB
- _ Multipurpose front + rear light kit for bicycles
- _ Front light 5 W CREE LED, 300 lm - 3 dimming steps 100/50/30% + intermittent
- _ COB LED rear light - 2 adjustment steps 100/60% + intermittent
- _ Charging time: 3.5h front light, 2h rear light.
- _ Front light duration: 100% 3.5 h, 50% 5.5 h, 30%, 6.5 h, flash 50% 6.5 h.
- _ Back light: 100% 4 h, 60% 6 h, flash 100% 8.5 h.
- _ Rechargeable via USB



CODICE	EAN	IMBALLO
9630004	6435200270498	6/24

LED BICYCLE REAR RED LIGHT

BTL CATEGORIA SCONTO 16



- _ Lampada posteriore per bici. Montaggio a sgancio rapido universale
- _ Interruttore ON/OFF con due modalità di funzionamento: fissa ed intermittente
- _ 5 LED
- _ Batterie: 2xAAA (non include)
- _ Rear lamp for bike. Universal quick release mounting
- _ ON / OFF switch with two operating modes: fixed and intermittent
- _ 5 LED
- _ Batteries: 2xAAA (not included)



CODICE	EAN	IMBALLO
8710465	6435200213587	6/72



LED BICYCLE REAR RED LIGHT TARO

BTL CATEGORIA SCONTO 16

- _ Lampada posteriore per bici. Montaggio a sgancio rapido universale
 - _ Interruttore ON/OFF con due modalità di funzionamento: fissa ed intermittente
 - _ 5 LED
 - _ Batterie: 2xAAA (non include)
- _ Rear lamp for bike. Universal quick release mounting
 - _ ON / OFF switch with two operating modes: fixed and intermittent
 - _ 5 LED
 - _ Batteries: 2xAAA (not included)



CODICE	EAN	IMBALLO
9630006	6435200274120	1/72

AIRAM HEADLIGHT

BTL CATEGORIA SCONTO 16



- _ Lampada headlight con inclinazione regolabile
 - _ Funzioni: luce bianca al 100% - luce bianca al 50% - luce rossa al 100% e modalità SOS
 - _ Durata fino a 30.000h
 - _ 1W - 80lm., non intercambiabile
 - _ Batterie 3XLR03 (non include)
- _ Headlight lamp with adjustable inclination
 - _ Functions: 100% white light - 50% white light - 100% red light and SOS mode
 - _ Duration up to 30,000h
 - _ 1W - 80lm., Not interchangeable
 - _ 3XLR03 batteries (not included)



CODICE	EAN	IMBALLO
LED25	6435200191328	6/48

AIRAM POWER HEADLIGHT

BTL CATEGORIA SCONTO 16



- _ Lampada headlight con inclinazione regolabile
 - _ Funzioni: luce bianca al 100% - luce bianca al 40% - luce rossa al 100% e luce rossa intermittente
 - _ Durata fino a 30.000h
 - _ 3W - 200lm CREE led, non intercambiabile
 - _ Batterie: 3XLR03 (non include)
- _ Headlight lamp with adjustable inclination
 - _ Functions: 100% white light - 40% white light - 100% red light and flashing red light
 - _ Duration up to 30,000h
 - _ 3W - 200lm CREE led, not interchangeable
 - _ Batteries: 3XLR03 (not included)

CODICE	EAN	IMBALLO
LED26	6435200204301	6/24

MAX 800 TORCIA LED FLASHLIGHT 800LM RICARICA USB

BTL CATEGORIA SCONTO 16



- _ Torcia portatile in alluminio
- _ Funzioni: 2 livelli di luminosità con funzione zoom
- _ 800lm
- _ Batteria ricaricabile tramite porta USB
- _ Ricarica: 2h
- _ Diametro 34 x lunghezza 155mm
- _ Portable aluminum flashlight
- _ Functions: 2 levels of brightness with zoom function
- _ 800lm
- _ Rechargeable battery via USB port
- _ Charging: 2h
- _ Diameter 34 x length 155mm



CODICE

EAN

IMBALLO

9630011

6435200272942

6/48

EXPO CLIPPY SAFETY LIGHT LED 12 PZ

BTL CATEGORIA SCONTO 16



- _ Portachiavi con LED 2W - 40lm
- _ Ideale per carrozzine, borse, bastoni o guinzagli per i cani
- _ 2 x CR2032 incluse
- _ Corpo in plastica
- _ Colori blu, rosso, verde o trasparente.
- _ Con espositore da 12 pezzi
- _ Keychain with LED 2W - 40lm
- _ Ideal for prams, bags, sticks or dog leashes
- _ 2 x CR2032 included
- _ Plastic body
- _ Blue, red, green or transparent colors
- _ With 12 pieces display

CODICE

EAN

IMBALLO

8710503

6435200236869

1/12

EXPO TORCE LED COLORI VARI 12 PZ

BTL CATEGORIA SCONTO 16



- _ Torcia in alluminio con impugnatura in gomma
- _ Cinturino di sicurezza
- _ 1W - 80lm
- _ 12 torce (4 rosse - 4 verdi - 4 blu)
- _ Batterie: 3xAAA (non incluse)
- _ Aluminum flashlight with rubber grip
- _ Safety strap
- _ 1W - 80lm
- _ 12 light torches (4 red - 4 green - 4 blue)
- _ Batteries: 3xAAA (not included)

CODICE

EAN

IMBALLO

8710490

6435200227737

1/4



EXPO TORCE LED13 COLORI VARI 12 PZ

NEW

BTL CATEGORIA SCONTO 16

- _ Corpo in gomma
- _ Cinturino di sicurezza
- _ 12 torce (3 rosse, 3 blu, 3 verdi, 3 nere)
- _ Batterie: 3xAAA incluse

- _ Rubber body
- _ Safety strap
- _ 12 flashlights (3 red, 3 blue, 3 green, 3 black)
- _ Batteries: 3xAAA included

CODICE
EAN
IMBALLO

LED13XKIT

8031453033118

1/4

EVOLUTION + ALKALINE

BTL CATEGORIA SCONTO 15



	CODICE	EAN	IMBALLO
Ministilo AAA 1,5V Evolution (BL 4 pz.)	LR03	6435200194725	1/10
Stilo AA 1,5V Evolution (BL 4 pz.)	LR6	6435200194749	1/10
Transistor 9V Evolution (BL 1pz)	6LR61	6435200194763	1/10

SUPER ALKALINE MULTIPACK

BTL CATEGORIA SCONTO 15



	CODICE	EAN	IMBALLO
Ministilo 1,5V Alkaline (Pack 10 pz.)	LR03/10	6435200275622	1
Ministilo 1,5V Alkaline (Pack 16 pz.)	LR03/16	6435200301383	1
Stilo 1,5V Alkaline (Pack 10 pz.)	LR6/10	6435200275585	1
Stilo 1,5V Alkaline (Pack 16 pz.)	LR6/16	6435200301345	1
1/2 Torcia C 1,5V Evolution (BL 2 pz.)	LR14/2	6435200192431	1
Torcia D 1,5V Evolution (BL 2 pz.)	LR20/2	6435200192455	1
Transistor 9V Evolution (BL 2pz)	6LR61/2	6435200192479	1

ALKALINE



BTL CATEGORIA SCONTO 15

_ Per apparecchi fotografici e calcolatori

_ For cameras and calculators

	CODICE	EAN	IMBALLO
Alkaline AG12/186 1,5V (BI 1 pz)	LR43	6435200138019	1/10
Alkaline A76 1,5V h.5,41 (BI 1 pz)	LR44	6435200138071	1/10
Alkaline LR1130/189 1,5V (BI 1 pz)	LR54	6435200138040	1/10

LITHIUM



BTL CATEGORIA SCONTO 15

	CODICE	EAN	IMBALLO
LITHIUM 3V CR17355	CR2	6435200138224	1/10
AIRAM LITHIUM BATTERY CR2450 1/BL	CR2450	6435200230843	1/10
LITHIUM 3V H.MM. 34,00	CR123A	6435200138255	1/10
LITHIUM 3V CR1220	CR1220	6435200230768	1/10
LITHIUM 3V CR1616	CR1616	6435200230782	1/10
LITHIUM 3V CR1620	CR1620	6435200230805	1/10
LITHIUM 3V 1,6h 20mm	CR2016	6435200138101	1/10
LITHIUM 3V H.MM. 2,50	CR2025	6435200138132	1/10
LITHIUM 3v H.MM. 3,20	CR2032	6435200138163	1/10
LITHIUM 3v (Pack 4 pz.)	CR2032/4	6435200215024	1/10
LITHIUM 3V CR2430	CR2430	6435200230829	1/10

SHOT
BOT LIGHTING

LAMPADE NOTTURNE
LED NIGHT LIGHTS



LUCE NOTTURNA POWER LED CREPUSCOLARE 230V

BTL CATEGORIA SCONTO 16



- _ Luce notturna da presa a basso consumo energetico e lunga durata
 - _ Interruttore automatico crepuscolare, si accende la sera e si spegne al mattino
 - _ Temperatura di colore: 2900K
 - _ 1W - 14lm non intercambiabile
- _ Low energy consumption and long lasting socket night light
 - _ Twilight automatic switch, turns on in the evening and turns off in the morning
 - _ Color temperature: 2900K
 - _ 1W - 14lm not interchangeable

IP 20

BLISTER

CODICE

EAN

IMBALLO

LED21

6435200173843

5/20

LUCE NOTTURNA POWER LED CREPUSCOLARE + SENSOR 230V

BTL CATEGORIA SCONTO 16



- _ Luce notturna da presa a basso consumo energetico e lunga durata
 - _ Interruttore automatico crepuscolare, si accende la sera e si spegne al mattino
 - _ Sensore di movimento, si accende solo quando rileva il passaggio
 - _ Temperatura di colore: 3000K
 - _ 1,8W - 15lm non intercambiabile
- _ Low energy consumption and long lasting socket night light
 - _ Twilight automatic switch, turns on in the evening and turns off in the morning
 - _ Motion sensor, it turns on only when it detects the passage
 - _ Color temperature: 3000K
 - _ 1,8W - 15lm not interchangeable

IP 20

BLISTER

CODICE

EAN

IMBALLO

LED23

6435200174949

6/48

LUCE NOTTURNA POWER LED CREPUSCOLARE ROUND 230V

BTL CATEGORIA SCONTO 16



- _ Luce notturna da presa a basso consumo energetico e lunga durata
 - _ Interruttore automatico crepuscolare, si accende la sera e si spegne al mattino
 - _ Temperatura di colore: 3000K
 - _ 0,4W - 1,5lm non intercambiabile
- _ Low energy consumption and long lasting socket night light
 - _ Twilight automatic switch, turns on in the evening and turns off in the morning
 - _ Color temperature: 3000K
 - _ 0.4W - 1.5lm not interchangeable

IP 20

BLISTER

CODICE

EAN

IMBALLO

LED24

6435200174956

6/48

LAMPADA DA ARMADIO CON SENSORE DI MOVIMENTO

BTL CATEGORIA SCONTO 16



- _ Lampada da armadio in policarbonato ABS con sensore di movimento PIR
 - _ Interruttore ON/OFF
 - _ Dimensioni: larghezza 300mm, lunghezza 45mm
 - _ Temperatura di colore 3000K
 - _ 1,2W - 80lm - 6 LED non intercambiabile
 - _ Batterie: 4 x AA 1,5V (non incluse)
- _ Wardrobe lamp in ABS polycarbonate with PIR motion sensor
 - _ ON / OFF switch
 - _ Dimensions: width 300mm, length 45mm
 - _ Color temperature: 3000K
 - _ 1,2W - 80lm - 6 non-interchangeable LEDs
 - _ Batteries: 4 x AA 1,5V (not included)

IP 20

BLISTER

CODICE

EAN

IMBALLO

8710464

6435200213563

5/40

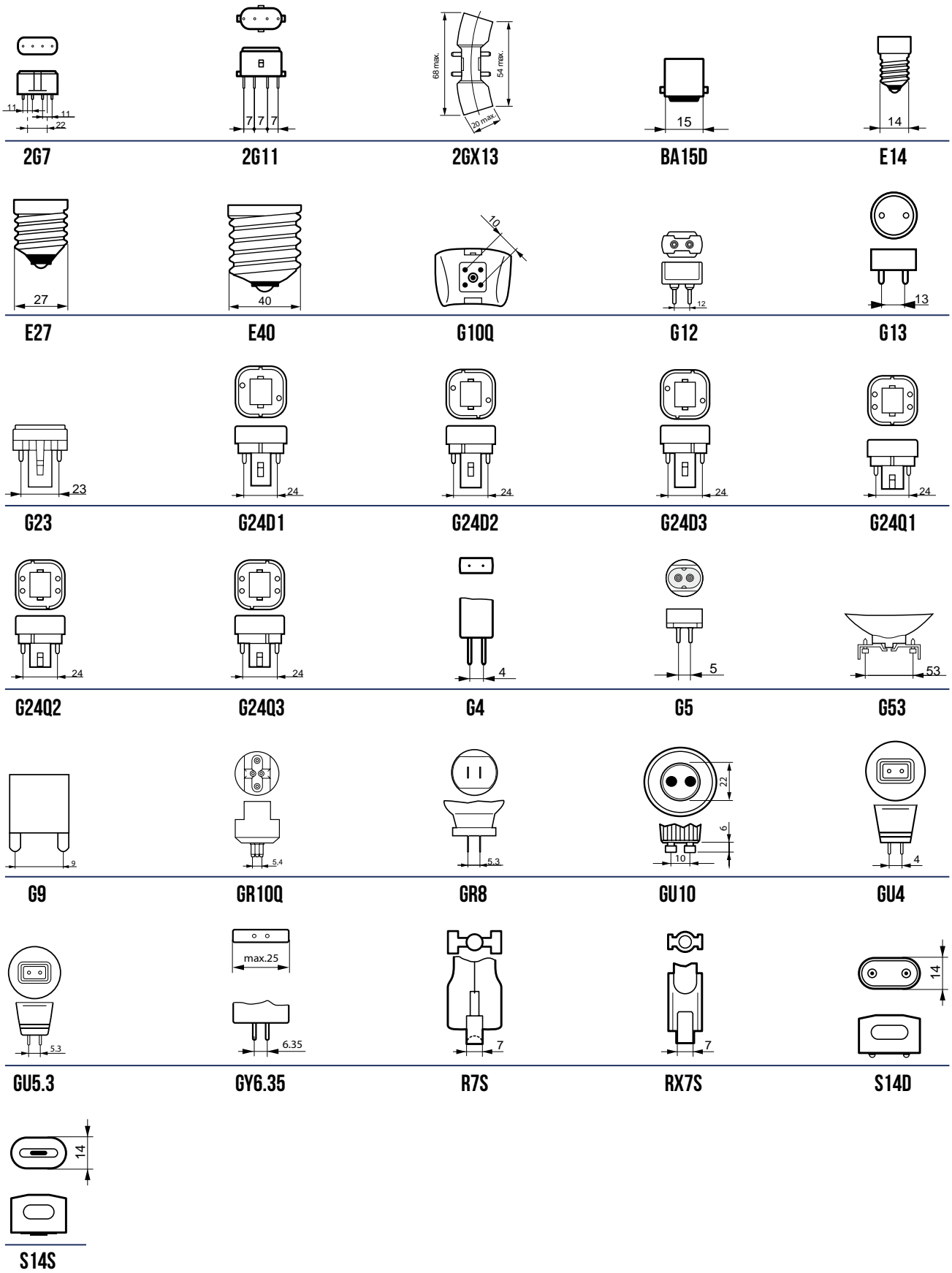



W= 1521 LUMEN 360	EQUIVALENZA CON SORGENTE TRADIZIONALE WATTAGE EQUIVALENT	Il Watt (W) è l'unità di misura della potenza elettrica assorbita. A sinistra è indicato il consumo della lampada mentre a destra è indicato il consumo (maggiore) di una sorgente tradizionale, incandescente od alogena, che produce un flusso luminoso equivalente.	<i>The Watt (W) is the unit of measurement of absorbed electrical power. The consumption of the lamp is indicated to the left, while on the right is the consumption (higher) of a traditional source, whether incandescent or halogen, which produces an equivalent luminous flux.</i>
	AMPIEZZA FASCIO LUMINOSO LIGHT BEAM ANGLE	Nelle lampade con emissione direzionale è indicata l'ampiezza del fascio luminoso espressa in gradi.	<i>In lamps with directional emission the angle of the light beam is given in degrees.</i>
	LUMEN UTILI USEFUL LUMEN	I lumen utili indicano la luce effettivamente emessa da una sorgente luminosa direzionale all'interno di un cono con angolo di apertura specifico: 120° per angoli del fascio > 90° e 90° per angoli del fascio < 90°.	<i>Useful lumens indicate the light effectively emitted by a directional light source within a cone with a specific beam angle: 120° for beam angles > 90° and 90° for beam angles < 90°.</i>
	IMBALLO PACKAGE	Descrive il tipo di confezionamento del prodotto.	<i>Describes the product's type of packaging.</i>
3000 4000 6500	TEMPERATURA GRADI K K TEMPERATURE DEGREES	La temperatura in gradi Kelvin è selezionabile tramite un selettore, che consente di cambiare il colore della luce dell'apparecchio in base alle esigenze.	<i>The temperature in Kelvin degrees is selectable through a selector, allowing the color temperature of the device to be adjusted according to requirements.</i>
	CLASSE ENERGETICA ENERGY CLASS	Mostra l'efficienza energetica dell'apparecchio, basata sulle nuove classi energetiche attuali (da A a G), dove la classe A rappresenta la migliore efficienza con consumi ridotti, mentre la classe G indica un'efficienza molto bassa.	<i>Shows the energy efficiency of the device, based on the new current energy classes (from A to G), where class A represents the highest efficiency with reduced consumption, while class G indicates very low efficiency.</i>
1100 cd	INTENSITA' MAX MAXIMUM INTENSITY	Nelle lampade con emissione direzionale, oltre alla quantità totale di luce emessa (lumen), viene anche indicata l'intensità massima espressa in candele (cd).	<i>In lamps with directional emission, in addition to the total quantity of light emitted (lumen), also the maximum intensity is given in candelas (cd).</i>
	RGB - TUNABLE WHITE	Nelle lampade smart, la funzione RGB consente di cambiare il colore della luce, mentre la funzione Tunable White permette di regolare la temperatura colore (espressa in gradi Kelvin) da luce fredda a luce calda.	<i>In smart lamps, the RGB function allows changing the light color, while the Tunable White function enables adjusting the color temperature (measured in Kelvin) from cool to warm light.</i>
WARM WHITE 4000 K COOL WHITE DAY LIGHT	COLORE DELLA LUCE LIGHT COLOUR	Una luce bianca viene caratterizzata dalla Temperatura di colore, espressa in Kelvin (K). La CCT viene espressa in gradi Kelvin; una luce calda si aggira sui 2700 K, un bianco neutro intorno ai 4000 K e un bianco freddo ai 5000 K o più. L'imballo riporta sia la descrizione sia la scala graduata con il valore esatto.	<i>A white light is characterised by the Colour Temperature, given in Kelvin (K). CCT is expressed in degrees Kelvin; a warm light is around 2700 K, a neutral white around 4000 K and a cool white at 5000 K or more. The packaging gives both the description and the graduated scale with the exact value.</i>
	GRADO DI PROTEZIONE IP INGRESS PROTECTION IP	Apparecchio con grado di protezione agli agenti esterni X (es: corpi solidi) e all'umidità Y (es: penetrazione liquidi) es valori da: IP20 (prodotto da interni) /44/65 (prodotto da esterni)...	<i>Luminaire with degree of protection against external agents X (eg: solid bodies) and moisture Y (eg: penetration of liquids) eg. values from IP20 (product for interiors) to IP44, IP65 (outdoor products)...</i>
	GRADO DI PROTEZIONE IMPATTI MECCANICI DEGREE OF PROTECTION MECHANICAL IMPACTS	Il grado di protezione IK è il grado di protezione contro gli impatti meccanici esterni. Con questa classificazione si identifica il grado di robustezza dell'apparecchio. Valori bassi da IK01 (impatto di 0,14 joule) ad alti valori IK10 (impatto pari a 20 joule).	<i>The IK degree of protection is the degree of protection against external mechanical impacts. This classification identifies the degree of robustness of the appliance. Low IK01 values (impact of 0.14 joules) to high IK10 values (impact of 20 joules).</i>
220-240V	ALIMENTAZIONE MAINS	Range tensione collegamento a alla rete elettrica.	<i>Connection mains Voltage range.</i>
	CLASSE I CLASS I	Apparecchio provvisto di collegamento di messa a terra di protezione.	<i>Luminaire with earth/ground connection.</i>
	CLASSE II CLASS II	Apparecchio che non richiede la connessione di messa a terra perché dotato di un doppio involucro di materiale isolante.	<i>Luminaire that does not require earth/ground connection because double insulated.</i>
	CLASSE III CLASS III	Apparecchio con tensioni non superiori alla bassissima tensione di sicurezza SELV (Safety Extra-Low Voltage). In pratica tale apparecchio viene alimentato o da una batteria o da un trasformatore SELV.	<i>Luminaire with voltages not exceeding the very low safety voltage SELV (Safety Extra-Low Voltage). In practice, this device is powered either by a battery or by a SELV transformer.</i>

	VITA NOMINALE NOMINAL LIFE	Indica la durata in ore a cui sopravvive il 50% delle lampade di un lotto campione. Per le lampade LED, si considera esaurita quando il flusso luminoso cala del 30% rispetto al valore iniziale.	Indicates the lifespan in hours at which 50% of the lamps in a sample batch survive. For LED lamps, they are considered expired when the luminous flux drops by 30% from the initial value.
	ACCENSIONI ON/OFF NUMBER OF ON/OFF CYCLES	Numero di accensioni per cui la lampada è collaudata.	Number of on/off cycles for which the lamp is tested.
	TEMPERATURA DI FUNZIONAMENTO OPERATING TEMPERATURE	Temperatura ambiente entro la quale l'apparecchio può lavorare correttamente.	Ambient temperature within which the luminaire operates correctly.
	REGOLAZIONE CCT CCT ADJUSTMENT	Possibilità di regolazione della temperatura di colore che definisce l'aspetto del colore di un LED bianco.	Possibility of adjusting the color temperature that defines the color appearance of a white LED.
	POTENZA SELEZIONABILE POWER SELECTABLE	Possibilità di regolazione della potenza dell'apparecchio tramite selettore.	Possibility to adjust the power of the device through a selector.
	 UTILIZZO CON DIMMERS DIMMER	Il simbolo indica se la lampada può essere o non può essere utilizzata con regolatori di luce.	The symbol indicates whether the lamp can or cannot be used with dimmers.
	OUTDOOR	Apparecchio adatto per esterni.	Luminaire for outdoor use.
	 PIR / RADAR	Apparecchio con sensore di rilevamento movimento: PIR: passivo ad infrarossi. RADAR: a microonde.	Luminaire with motion detection sensor: PIR: passive infrared. RADAR: microwave.
	APPARECCHIO EMERGENZA EMERGENCY FIXTURE	Apparecchio a funzione luce di emergenza.	Emergency light luminaire.
	 APP DIMMABLE WIRELESS	Nelle lampade smart, è possibile regolare la dimmerazione (intensità luminosa) tramite collegamento wireless, consentendo un controllo pratico e personalizzato dell'illuminazione.	In smart lamps, it is possible to adjust dimming (light intensity) via wireless connection, allowing for practical and customized lighting control.
	INDICE RESA CROMATICA COLOR RENDERING INDEX	L'indice di resa cromatica (CRI) è una scala da 0 a 100 che misura la capacità di una sorgente luminosa di riprodurre accuratamente i colori. Un CRI superiore a 90 è eccellente, mentre un valore tra 80 e 90 è considerato buono, garantendo colori abbastanza fedeli.	The Color Rendering Index (CRI) is a scale from 0 to 100 that measures a light source's ability to accurately reproduce colors. A CRI above 90 is excellent, while a value between 80 and 90 is considered good, ensuring fairly accurate colors.
	INDICE UNIFICATO ABBAGLIAMENTO UNIFIED GLARE RATING	UGR (Unified Glare Rating) è l'indice che misura l'abbagliamento luminoso molesto, regolato da normative europee e nazionali per gli ambienti lavorativi. Ad esempio: UGR 16 per laboratori di disegno e sale operatorie, UGR 19 per uffici e aule, UGR 28 per corridoi e ingressi.	UGR (Unified Glare Rating) measures disturbing light glare and is regulated by European and national standards for workplaces. For example: UGR 16 for drawing labs and operating rooms, UGR 19 for offices and classrooms, UGR 28 for corridors and entrances.
	DOPPIO FUSIBILE DOUBLE FUSE	Lampada con doppio fusibile all'interno del corpo.	Lamp with double fuse, internally mounted.
	CONFEZIONE PACKAGING	Confezione di tipo blister.	Blister pack.
	 TECNOLOGIA LAMPADA LAMP TECHNOLOGY	MH: a ioduri metallici / MHC: ioduri metallici e bruciatore ceramico / HPS: al sodio.	MH: metal iodide / MHC: metal iodide lamp with ceramic burner / HPS: sodium lamp.
			

Qualità del prodotto, tecnologia innovativa, durata e caratteristiche illuminotecniche risultano gli elementi vincenti delle lampade a LED di Bot Lighting, per questo motivo abbiamo deciso di offrire un vantaggio esclusivo al nostro cliente.

Product quality, innovative technology, duration and lighting engineering features make the LED lamps by Bot Lighting a sure success, which is why we are offering our customers an exclusive advantage.



LAMPADE CON VITA
MEDIA NOMINALE
< 25.000 ORE

LAMPS WITH NOMINAL
AVERAGE LIFETIME
< 25,000 HOURS



LAMPADE CON VITA
MEDIA NOMINALE
≥ 25.000 ORE
E MINORE DI
40.000 ORE

LAMPS WITH NOMINAL
AVERAGE LIFETIME
≥ 25,000 HOURS
AND LESS THAN
40,000 HOURS



LAMPADE CON VITA
MEDIA NOMINALE
≥ 40.000 ORE

LAMPS WITH NOMINAL
AVERAGE LIFETIME
≥ 40,000 HOURS

La presente garanzia copre esclusivamente i Prodotti impiegati alle seguenti condizioni di utilizzo che devono verificarsi contemporaneamente ai fini della copertura di garanzia:

- I prodotti devono essere installati correttamente ed utilizzati secondo le istruzioni.
- I prodotti devono funzionare in un range di tensione pari a 230 V +/- 10%.
- L'umidità nell'impianto non superi mai l'80%
- Il periodo di garanzia presuppone un utilizzo di funzionamento massimo di 4.000 ore all'anno ad una temperatura costante di 25 ° con 10 mm. minimo di spazio intorno alla lampada.
- Il periodo di garanzia decorre a partire dalla data di acquisto riportata sulla fattura/scontrino fiscale e/o dal lotto di produzione riportato su ciascun prodotto.
- Le sorgenti luminose a LED sono progettate per essere installate in apparecchi aperti e con sufficiente ventilazione. L'impiego in apparecchi chiusi ne può ridurre sensibilmente la durata ed invalida la garanzia.

Approfondimento termini e condizioni di garanzia
www.botlighting.it/warranty

This warranty only covers Products used according to the conditions of use listed below, which must all be met for the purpose of warranty coverage.

- *The products must be properly installed and used in accordance with the manufacturer's instructions.*
- *The products must operate in a voltage range of 230 V +/- 10%.*
- *The humidity in the system never exceeds 80%*
- *The warranty period assumes a maximum operating use of 4,000 hours per year at a constant temperature of 25 ° with 10 mm. minimum space around the lamp.*
- *The warranty period starts from the date of purchase shown on the invoice / receipt and / or from the production lot shown on each product.*
- *LED light sources are designed to be installed in open fixtures with sufficient ventilation. The use in closed appliances can significantly reduce the duration and invalidate the warranty*

More info
www.botlighting.it/warranty

1. Gli ordini sono subordinati all'accettazione del fornitore. Le offerte ed accettazioni di ordini si intendono ai prezzi ed alle condizioni di vendita in vigore al momento della spedizione della merce, salvo disponibilità. Gli ordini anche se raccolti tramite il nostro personale di vendita, sono vincolati all'accettazione da parte di BOT LIGHTING Srl, che può essere anche parziale.

2. Alla Venditrice non potrà essere addossata alcuna responsabilità per mancata accettazione, ovvero per mancata o ritardata fornitura dei prodotti oggetto dello stesso. L'accettazione e l'esecuzione dell'ordine sono specificatamente subordinate alla disponibilità dei prodotti ordinati nonché all'assenza di circostanze che possano comunque influire sulla reperibilità degli stessi e sulla loro tempestività di consegna. I termini di consegna sono indicativi e l'acquirente non può pretendere la rifusione di danni in caso di ritardi nelle consegne per cause non imputabili al fornitore. Gli eventuali ritardi nelle consegne, così come le interruzioni e/o sospensioni totali o parziali delle forniture, anche se non dovute a causa di forza maggiore e/o caso fortuito, non daranno diritto al risarcimento di danni e/o indennizzi di qualsiasi tipo, ivi inclusi quelli diretti, indiretti e consequenziali, nonché interessi.

3. La merce viaggia a rischio e pericolo dell'acquirente e in caso di furti, manomissioni, l'acquirente dovrà rivolgersi esclusivamente al vettore. In qualsiasi caso le anomalie riscontrate alla consegna dovranno essere notificate a BOT LIGHTING Srl con la seguente modalità:

- nel caso di colli sfusi verificare sempre all'atto della consegna il numero esatto dei colli e le eventuali rotture. Eventuali riserve precise dovranno sempre esser verbalizzate sul documento di trasporto e sull'eventuale bollettino del trasportatore.

- nel caso di bancali e quindi di impossibilità al controllo immediato alla consegna è necessario accettare la consegna stessa con "riserva di verifica" da esser segnalata nell'apposito riquadro del documento di trasporto e nell'eventuale bollettino del corriere.

I reclami dovranno pervenire a BOT LIGHTING Srl entro 3 giorni dal ricevimento del materiale.

4. Non appena ricevuti i prodotti, l'Acquirente sarà tenuto a verificare lo stato, la quantità della fornitura e la sua rispondenza alla bolla di consegna. Eventuali reclami in merito alla qualità, quantità, tipo del prodotto, dovranno essere fatti per iscritto entro 5 (cinque) giorni dalla data di ricevimento della merce. Decorso tale termine, fatte comunque salve le diverse condizioni di garanzia previste per i singoli prodotti, nessun reclamo potrà essere avanzato sia per la sostanza e la qualità della merce, sia per le condizioni in genere della stessa.

5. Eventuali difetti di fabbricazione dovranno essere tempestivamente denunciati e, dopo verifica di accertamento, saranno dal fornitore accreditati in toto od in parte, oppure sostituiti. Eventuali resi dovranno esser preventivamente concordati con il fornitore e si intendono "salvo verifica".

6. I prezzi di listino formulati si intendono per merce franca presso il deposito del fornitore; imballi speciali, assicurazione, resa e trasporto, imposte e tasse (IVA, ecc.) sono addebitabili a parte. Il prezzo indicato in tabella è da considerarsi come € prezzo suggerito al pubblico.

7. Nel commercio dei prodotti, oggetto del contratto, l'acquirente si asterrà da qualsiasi atto contrario ai principi della concorrenza leale, in conformità alle leggi, ai regolamenti nonché agli usi, in quanto compatibili.

8. Il pagamento della merce, nei termini ed alle condizioni di volta in volta stabiliti, dovrà esser effettuato presso il domicilio del fornitore, oppure ad un incaricato a ciò espressamente delegato. In quest'ultimo caso i pagamenti non si intendono effettuati finché le relative somme non pervengano alla sede centrale. Il mancato rispetto delle condizioni di pagamento stabilite o pagamenti differiti rispetto alle condizioni inizialmente concordate, determineranno l'applicazione degli interessi di mora, decorrenti dalla data di scadenza di pagamento della fattura e da determinarsi in base alla normativa di legge al momento vigente. In caso di controversia, per qualsiasi ragione, l'acquirente non ha alcun diritto di ritardare o di rifiutare il pagamento delle fatture scadute. Eventuali sconti cassa, nonché abbuoni o premi di qualsiasi natura saranno riconosciuti a condizione che il cliente non abbia pagamenti in sospeso e si intenderanno automaticamente decaduti e revocati in caso di mancato o ritardato pagamento. Ci riserviamo la facoltà di non dare esecuzione agli ordini di acquirenti che non abbiano provveduto al puntuale pagamento di forniture precedenti.

9. In caso di controversie si stabilisce la competenza esclusiva del Foro di Venezia.

10. La BOT LIGHTING Srl è impegnata a sviluppare e migliorare i propri prodotti. Per questa ragione tutte le descrizioni di questo catalogo-listino sono intese come guida generale e le specifiche possono essere cambiate di volta in volta nell'interesse del miglioramento del prodotto. Inoltre, eventuali modifiche sulle caratteristiche e sulla gamma di prodotti commercializzati che possono essere apportati dai produttori in qualsiasi momento senza preavviso, escludono la Bot Lighting Srl da alcuna responsabilità.

1. *Orders are subject to acceptance by the supplier. Quotations and acceptances of orders are agreed as at the prices and on the terms and conditions of sale in force at the time of dispatching the goods, subject to availability. Even if orders have been taken through our sales staff, final acceptance, which may be partial, has to be made by BOT LIGHTING Srl.*

2. *The Seller shall not be held liable for non-acceptance or for failure or delay in supplying the products forming the subject matter of the supply. Acceptance and processing of the order are specifically subject to the availability of the ordered products as well as the absence of circumstances which could in any way affect the availability of the same and prompt delivery thereof. The delivery times are given as an indication and the buyer may not make any claim in the event of delays in deliveries due to causes not attributable to the supplier. Any delays in deliveries, as also total or partial stoppages or suspensions of supplies, even when not due to force majeure, do not entitle the customer to claim for damage or loss, whether direct, indirect or consequential, or indemnity of any type whatsoever, or interest.*

3. *The goods travel at the buyer's risk and in the event of theft or tampering, the buyer shall contact the carrier, whereas any faults or defects found at the time of delivery shall be reported to BOT LIGHTING Srl*

as follows:

- in the case of loose packs, always check at the time of delivery the precise number of packs and check for any breakages. Any reservations shall always be written on the transport document and on any carrier's delivery note.

- in the case of pallets and therefore the impossibility of an immediate check of the goods, it is necessary to accept the delivery with "subject to checking" to be written in the relative box on the transport document and on any carrier's delivery note.

Complaints shall be sent to BOT LIGHTING Srl within 3 days of receiving the material.

4. *The Buyer is obliged to check the state and quantity of the supply as well as its compliance with the delivery note as soon as the products have been received. Any complaints regarding quality, quantity and type of product shall be made in writing within 5 (five) days from the date of receiving the goods. After that period, without prejudice to other warranty conditions given for single products, no complaint may be made either for the substance and quality of the goods or for the general conditions of the same.*

5. *Any manufacturing defects shall be promptly reported and, after verification and assessment, the goods will either be replaced or the amount paid for the same credited in full or in part to the customer by the supplier. Any returns shall be previously agreed with the supplier and are agreed as "subject to verification".*

6. *The list prices given are agreed as for goods ex supplier's warehouse; special packaging, insurance, delivery and transportation, duties and taxes (VAT, etc.) are charged separately. The price indicated is to be considered the recommended retail price.*

7. *In selling the products forming the subject matter of the contract, the buyer will refrain from any act contrary to the principles of fair competition, in compliance with the law, regulations and accepted practice, insofar as they are compatible.*

8. *The goods shall be paid, within the times and on the conditions established case by case, c/o the domicile of the supplier or to an expressly designated person. In the latter case the payments are not considered as made until the relative sums are received at head office. Failure to comply with the established conditions of payment or deferred payments in respect of the initially agreed conditions will result in the application of default interest as from the due date of payment of the invoice, to be determined according to the provisions of law in force at the time. In the event of a dispute, for any reason whatsoever, the buyer is not entitled to delay or to refuse payment of the overdue invoices. Any cash discounts as well as allowances or bonuses of any kind will be acknowledged provided that the customer has no outstanding payments, but will be agreed as automatically forfeited and revoked in the event of late or non-payment. We reserve the right not to carry out the orders of buyers who have not arranged for punctual payment of previous supplies.*

9. *In the event of disputes, it is established that the Court of Venice shall have sole jurisdiction.*

10. *BOT LIGHTING Srl is committed to developing and improving its products. All the descriptions in this catalogue-price list are therefore agreed as being a general guide and the specifications may be changed from time to time in the interests of product improvement. Furthermore, Bot Lighting Srl cannot be held liable for any changes to the characteristics and the range of outsourced products, which may be introduced by the manufacturers at any time without notice.*



BOT LIGHTING

FOR A BRIGHT FUTURE



Scansiona
per visitare
il nostro sito

BOT LIGHTING S.r.l.

Via Lombardia 37/39
30030 Cazzago di Pianiga
Venezia - Italy
T. +39 041 51 29 411

www.botlighting.it
info@botlighting.it
ordini@botlighting.it



METEL BTL